

On-Board Type (DC) EMI Suppression Filters (EMIFIL[®]) for Automotive

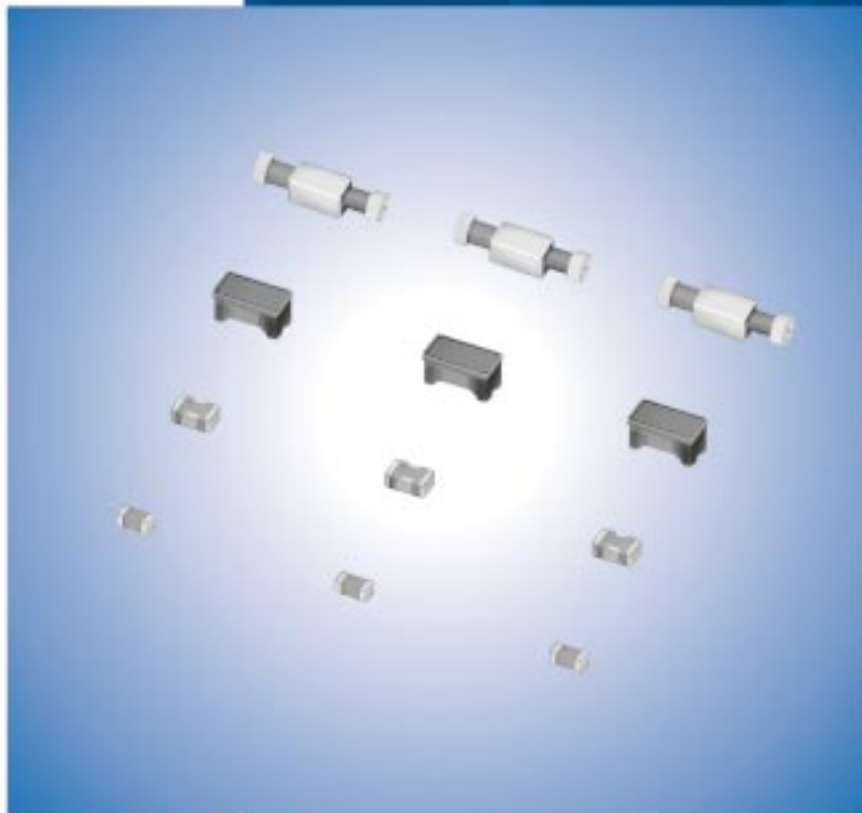

Cat.No.C50E-7

muRata *Innovator
in Electronics*
Murata
Manufacturing Co., Ltd.

EU RoHS Compliant

- All the products in this catalog comply with EU RoHS.
- EU RoHS is "the European Directive 2011/65/EU on the Restriction of the Use of Certain Hazardous Substances in Electrical and Electronic Equipment."
- For more details, please refer to our website 'Murata's Approach for EU RoHS' (<http://www.murata.com/info/rohs.html>).

CONTENTS

EMIFIL® and "EMIFIL" in this catalog are the trademarks of Murata Manufacturing Co., Ltd.

1

Product Guide/Effective Frequency Range	2
1 Chip Ferrite Beads Part Numbering	3
●BLM15A/18A/21A/31A	4
●BLM15B/18B/21B	12
●BLM18P/21P/31P/41P	25
●For GHz Range Noise Suppression BLM18H/18E	33
● Specifications and Test Methods	38
2 Chip EMIFIL®	
Part Numbering	42
Chip EMIFIL® Capacitor Type NFM21H Series	43
● Specifications and Test Methods	44
Chip EMIFIL® LC Combined Type for Large Current NFE61H Series	47
● Specifications and Test Methods	48
3 Chip Common Mode Choke Coils	
Part Numbering	50
Chip Common Mode Choke Coil DLW31S/43S Series	51
● Specifications and Test Methods	54
4 Block Type EMIFIL®	
Block Type EMIFIL® SMD Type BNX024H/025H Series	57
Block Type EMIFIL® Lead Type BNX012H Series	58
● Specifications and Test Methods	60
⚠Caution/Notice	64
Soldering and Mounting	67
Package	76
Design Kits	78
Outlines of Major Noise Regulation Standards	82
Principles of Noise Suppression by DC EMIFIL®	87



















2

3

4

Product Guide/Effective Frequency Range

Product Guide

Type	Series	Dimensions		Effective Frequency Range								
		(mm)	EIA Code	10kHz	100kHz	1MHz	10MHz	100MHz	1GHz	10GHz		
Inductor Type	Standard	 BLM15A	$\frac{1.0}{\pm 0.5}$	0402								
		 BLM18A	$\frac{1.6}{\pm 0.8}$	0603								
		 BLM21A	$\frac{2.0}{\pm 1.25}$	0805								
		 BLM31A	$\frac{3.2}{\pm 1.6}$	1206								
	For High Speed Signals	 BLM15B	$\frac{1.0}{\pm 0.5}$	0402								
		 BLM18B	$\frac{1.6}{\pm 0.8}$	0603								
		 BLM21B	$\frac{2.0}{\pm 1.25}$	0805								
	For High Current	 BLM18P	$\frac{1.6}{\pm 0.8}$	0603								
		 BLM21P	$\frac{2.0}{\pm 1.25}$	0805								
		 BLM31P	$\frac{3.2}{\pm 1.6}$	1206								
		 BLM41P	$\frac{4.5}{\pm 1.6}$	1806								
	For GHz Range Noise Suppression	 BLM18HG	$\frac{1.6}{\pm 0.8}$	0603								
		 BLM18HD	$\frac{1.6}{\pm 0.8}$	0603								
 BLM18EG		$\frac{1.6}{\pm 0.8}$	0603									
Capacitor Type	Standard Type 	NFM21H	$\frac{2.0}{\pm 1.25}$	0805								
	T Filter for High Current 	NFE61H	$\frac{6.8}{\pm 1.6}$	2706								
Chip Common Mode Choke Coils	 DLW31S	$\frac{3.2}{\pm 1.6}$	1206									
	 DLW43S	$\frac{4.5}{\pm 3.2}$	1812									
Block Type EMIFIL® 	BNX024H/025H BNX012H											

On-Board Type (DC) EMI Suppression Filters (EMIFIL®) for Automotive



Chip Ferrite Beads Part Numbering

Chip Ferrite Beads for Automotive

(Part Number)

BL	M	18	AG	102	S	H	1	D
①	②	③	④	⑤	⑥	⑦	⑧	⑨

① Product ID

Product ID	
BL	Chip Ferrite Beads

② Type

Code	Type
M	Monolithic Type

③ Dimensions (L×W)

Code	Dimensions (L×W)	EIA
15	1.0×0.5mm	0402
18	1.6×0.8mm	0603
21	2.0×1.25mm	0805
31	3.2×1.6mm	1206
41	4.5×1.6mm	1806

④ Characteristics/Applications

Code *1	Characteristics/Applications	Series
AG	for General Use	BLM15/18/21/31
AJ		
BA	for High-speed Signal Lines	BLM18
BB		BLM15/18/21
BD		
PG		for Power Supplies
HG	for GHz Band General Use	BLM18
EG	for GHz Band General Use (Low DC Resistance Type)	
HD	for GHz Band High-speed Signal Lines	

*1 Frequency characteristics vary with each code.

⑨ Packaging

Code	Packaging	Series
K	Embossed Taping (ø330mm Reel)	BLM21 *1/31/41
L	Embossed Taping (ø180mm Reel)	
B	Bulk	All Series
J	Paper Taping (ø330mm Reel)	BLM15/18/21 *2
D	Paper Taping (ø180mm Reel)	

*1 BLM21BD222SH1/BLM21BD272SH1 only.

*2 Except BLM21BD222SH1/BLM21BD272SH1

⑤ Impedance

Expressed by three figures. The unit is in ohm (Ω). The first and second figures are significant digits, and the third figure expresses the number of zeros which follow the two figures.

⑥ Electrode

Expressed by a letter.

Ex.)

Code	Electrode
S/T	Sn Plating
W	Ag/Pd

⑦ Category

Code	Category
H	for Automotive

⑧ Number of Circuits

Code	Number of Circuits
1	1 Circuit

On-Board Type (DC) EMI Suppression Filters (EMIFIL®) for Automotive



Chip Ferrite Beads BLM15/18/21/31/41 Series

BLM15A Series

■ Features

The chip ferrite beads BLM series is designed to function nearly as a resistor at noise frequencies, which greatly reduces the possibility of resonance and leaves signal wave forms undistorted.

BLM series is effective in circuits without stable ground lines because BLM series does not need a connection to ground.

The nickel barrier structure of the external electrodes provides excellent solder heat resistance.

BLM_A series generates an impedance from the relatively low frequencies. Therefore BLM_A series is effective in noise suppression in a wide frequency range (30MHz to several hundred MHz).

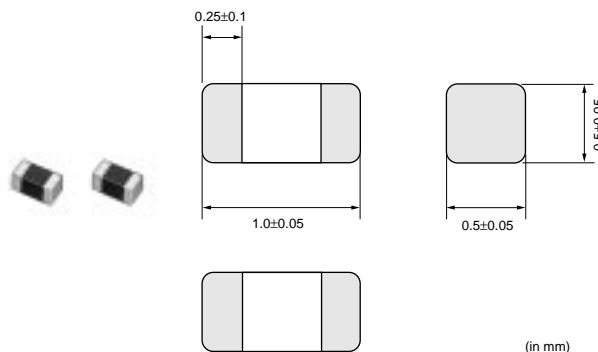

Part Number	Impedance (at 100MHz/20°C) (ohm)	Rated Current (mA)	DC Resistance (max.) (ohm)	Operating Temperature Range (°C)
BLM15AG100SH1	10 (Typ.)	1000	0.05	-55 to +125
BLM15AG700SH1	70 (Typ.)	500	0.15	-55 to +125
BLM15AG121SH1	120 ±25%	500	0.25	-55 to +125
BLM15AG221SH1	220 ±25%	300	0.35	-55 to +125
BLM15AG601SH1	600 ±25%	300	0.6	-55 to +125
BLM15AG102SH1	1000 ±25%	200	1.0	-55 to +125

■ Equivalent Circuit

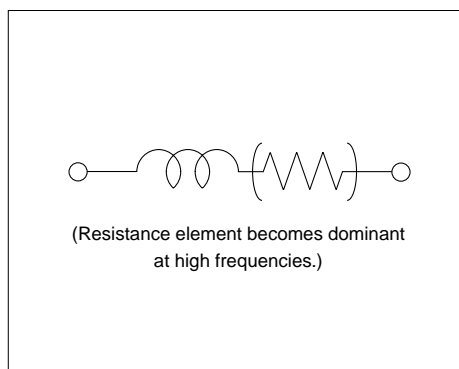

■ Impedance - Frequency (Typical)

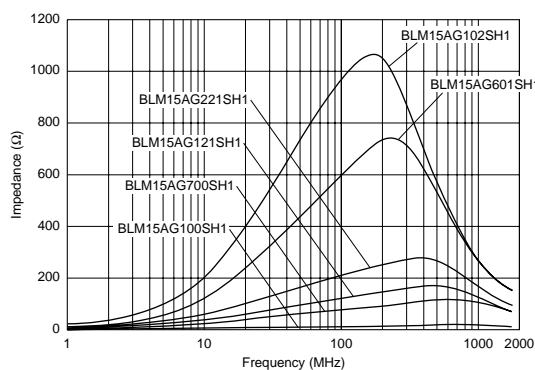

Continued on the following page. ↗

Continued from the preceding page.

Impedance - Frequency Characteristics

1

BLM15AG100SH1

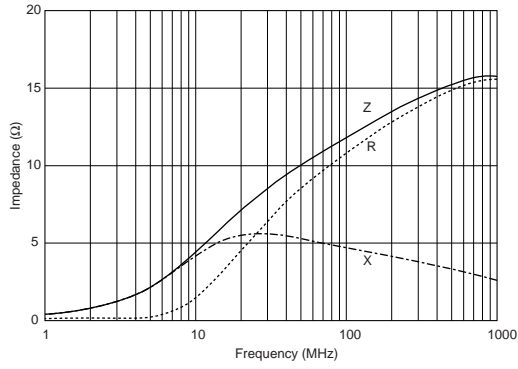

BLM15AG700SH1

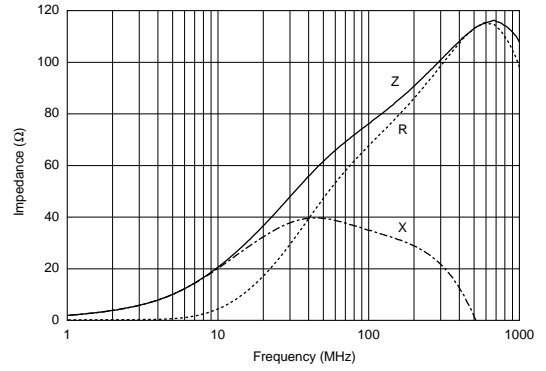

BLM15AG121SH1

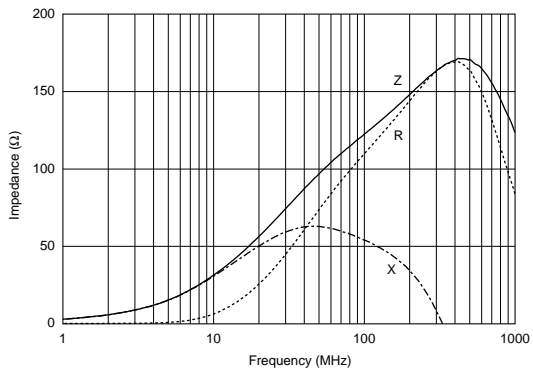

BLM15AG221SH1

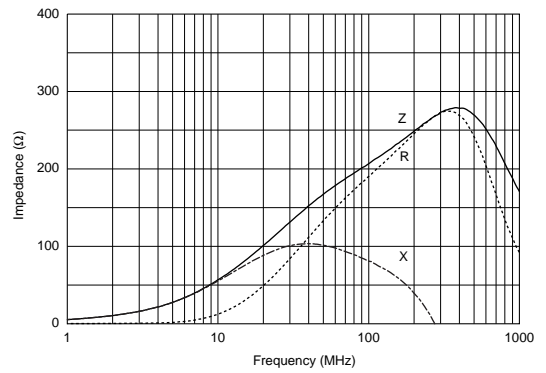

BLM15AG601SH1

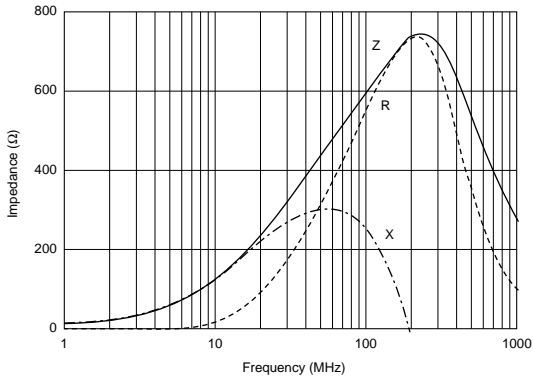

BLM15AG102SH1

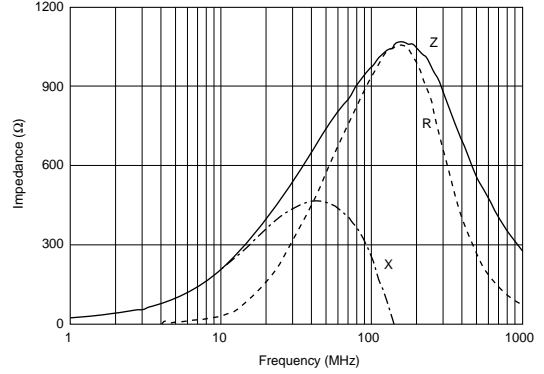

BLM18A Series

■ Features

The chip ferrite beads BLM series is designed to function nearly as a resistor at noise frequencies, which greatly reduces the possibility of resonance and leaves signal wave forms undistorted.

BLM series is effective in circuits without stable ground lines because BLM series does not need a connection to ground.

The nickel barrier structure of the external electrodes provides excellent solder heat resistance. BLM_A series generates an impedance from the relatively low frequencies. Therefore BLM_A series is effective in noise suppression in a wide frequency range (30MHz to several hundred MHz).

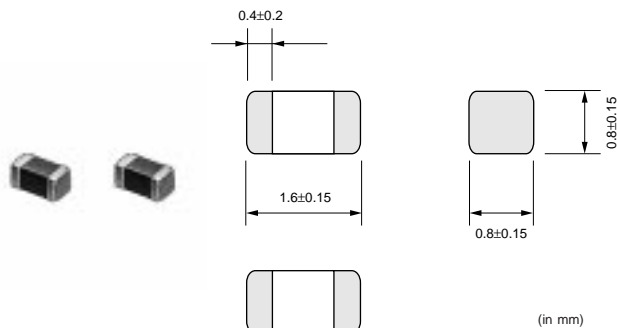

Part Number	Impedance (at 100MHz/20°C) (ohm)	Rated Current (mA)	DC Resistance (max.) (ohm)	Operating Temperature Range (°C)
BLM18AG121SH1	120 ±25%	500	0.18	-55 to +125
BLM18AG151SH1	150 ±25%	500	0.25	-55 to +125
BLM18AG221SH1	220 ±25%	500	0.25	-55 to +125
BLM18AG331SH1	330 ±25%	500	0.30	-55 to +125
BLM18AG471SH1	470 ±25%	500	0.35	-55 to +125
BLM18AG601SH1	600 ±25%	500	0.38	-55 to +125
BLM18AG102SH1	1000 ±25%	400	0.50	-55 to +125

■ Equivalent Circuit

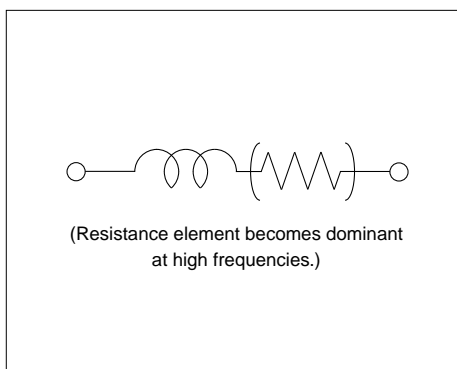

■ Impedance - Frequency (Typical)

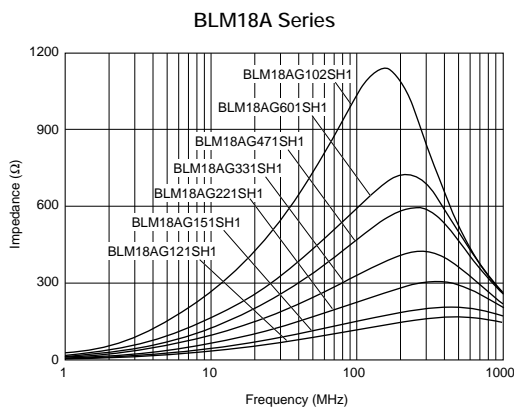

■ Impedance - Frequency Characteristics

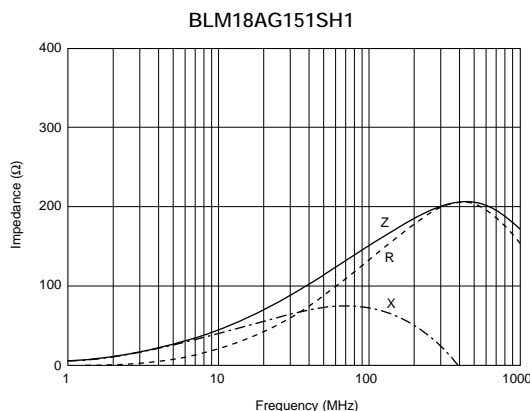
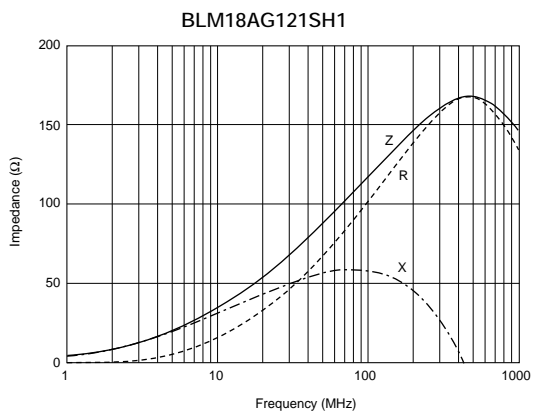

Continued on the following page. ↗

Continued from the preceding page.

Impedance - Frequency Characteristics

1

BLM18AG221SH1

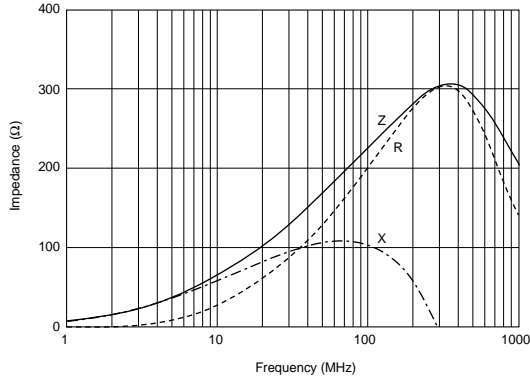

BLM18AG331SH1

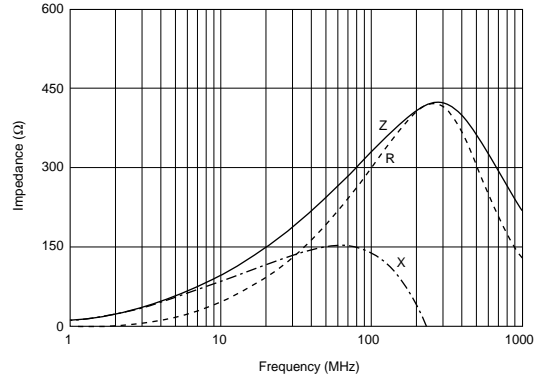

BLM18AG471SH1

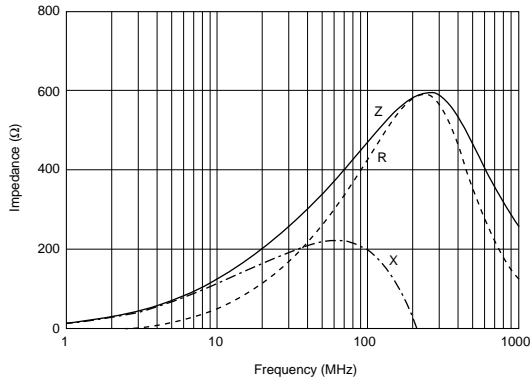

BLM18AG601SH1

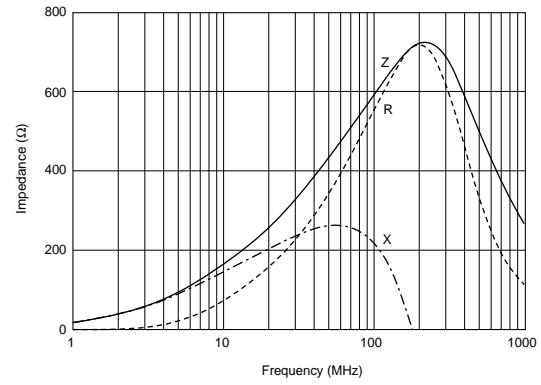

BLM18AG102SH1

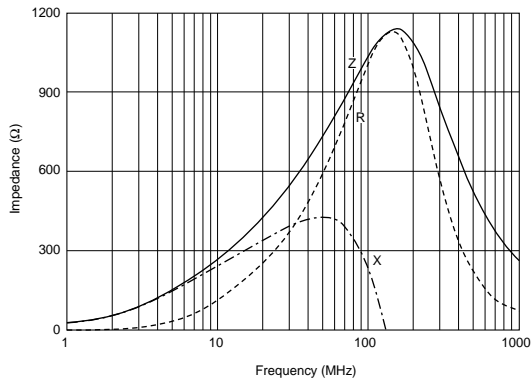

BLM18A Series Conductive Glue Applicable Type

■ Features

The chip ferrite beads BLM series is designed to function nearly as a resistor at noise frequencies, which greatly reduces the possibility of resonance and leaves signal wave forms undistorted.

BLM series is effective in circuits without stable ground lines because BLM series does not need a connection to ground.

BLM_A series generates an impedance from the relatively low frequencies. Therefore BLM_A series is effective in noise suppression in a wide frequency range (30MHz to several hundred MHz).

BLM18A_WH series is designed for conductive glue mounting method, not for normal soldering method. Please contact us for applicable mounting method for BLM18A_WH series.

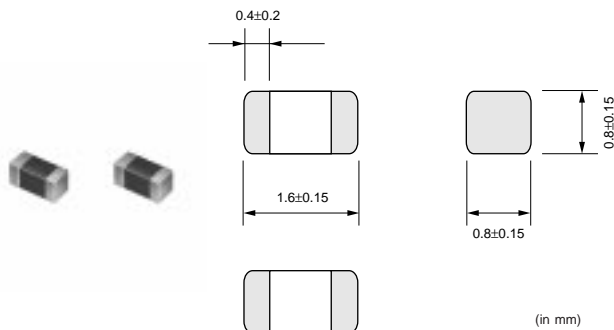

Part Number	Impedance (at 100MHz/20°C) (ohm)	Rated Current (mA)	DC Resistance (max.) (ohm)	Operating Temperature Range (°C)
BLM18AG471WH1	470 ±25%	200	0.20	-55 to +150
BLM18AG102WH1	1000 ±25%	200	0.70	-55 to +150

■ Equivalent Circuit

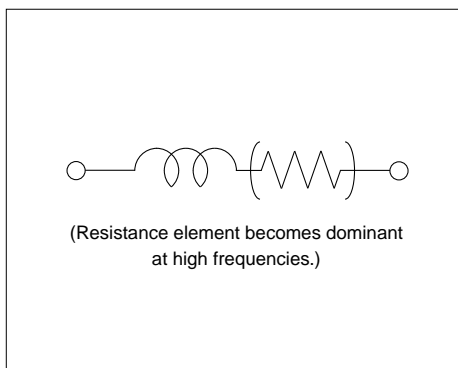

■ Impedance - Frequency (Typical)

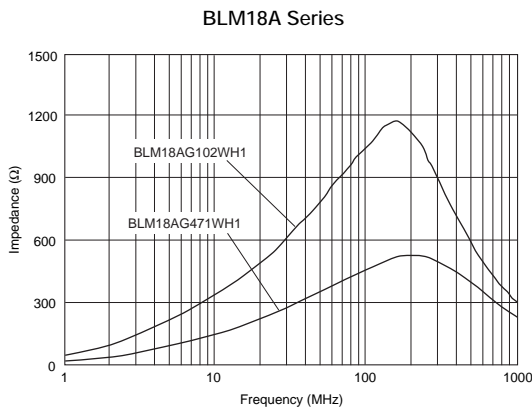

■ Impedance - Frequency Characteristics

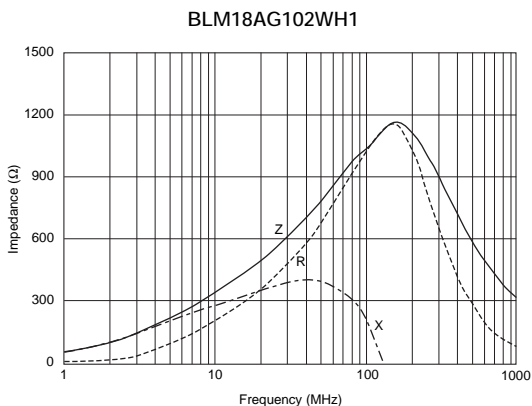
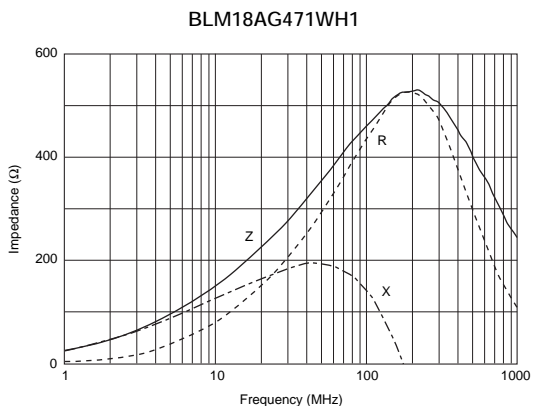

BLM21A Series

■ Features

The chip ferrite beads BLM series is designed to function nearly as a resistor at noise frequencies, which greatly reduces the possibility of resonance and leaves signal wave forms undistorted.

BLM series is effective in circuits without stable ground lines because BLM series does not need a connection to ground.

The nickel barrier structure of the external electrodes provides excellent solder heat resistance.

BLM_A series generates an impedance from the relatively low frequencies. Therefore BLM_A series is effective in noise suppression in a wide frequency range (30MHz to several hundred MHz).

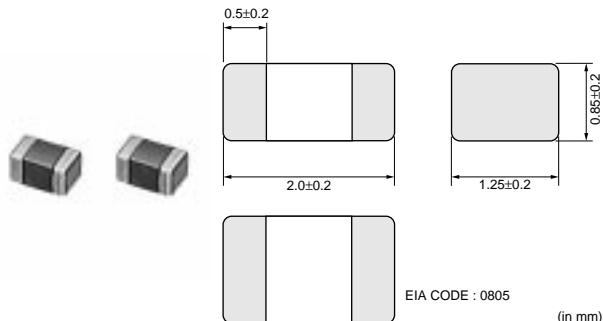

Part Number	Impedance (at 100MHz/20°C) (ohm)	Rated Current (mA)	DC Resistance (max.) (ohm)	Operating Temperature Range (°C)
BLM21AG121SH1	120 ±25%	200	0.15	-55 to +125
BLM21AG151SH1	150 ±25%	200	0.15	-55 to +125
BLM21AG221SH1	220 ±25%	200	0.20	-55 to +125
BLM21AG331SH1	330 ±25%	200	0.25	-55 to +125
BLM21AG471SH1	470 ±25%	200	0.25	-55 to +125
BLM21AG601SH1	600 ±25%	200	0.30	-55 to +125
BLM21AG102SH1	1000 ±25%	200	0.45	-55 to +125

■ Equivalent Circuit

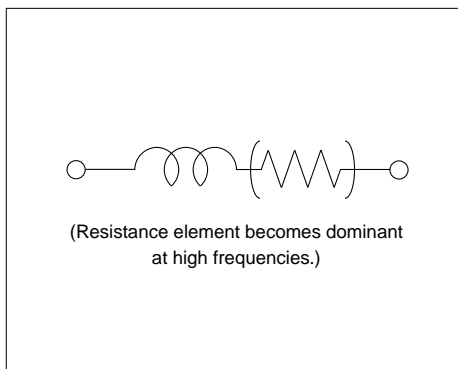

■ Impedance - Frequency (Typical)

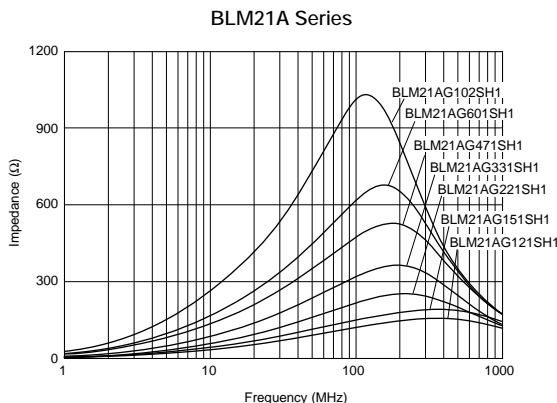

■ Impedance - Frequency Characteristics

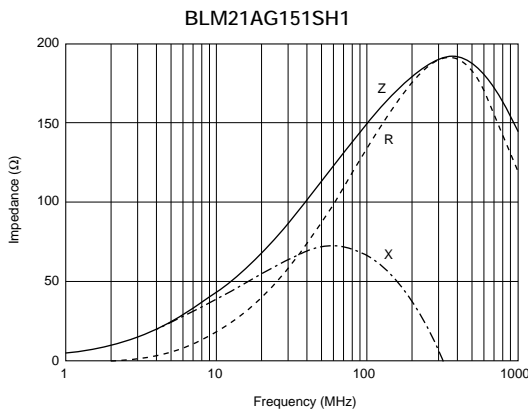
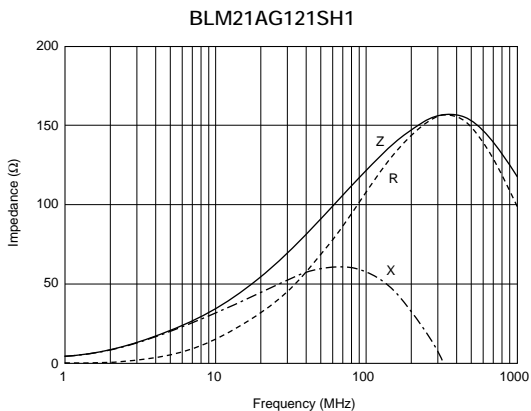

Continued on the following page. ↗

Continued from the preceding page.

Impedance - Frequency Characteristics

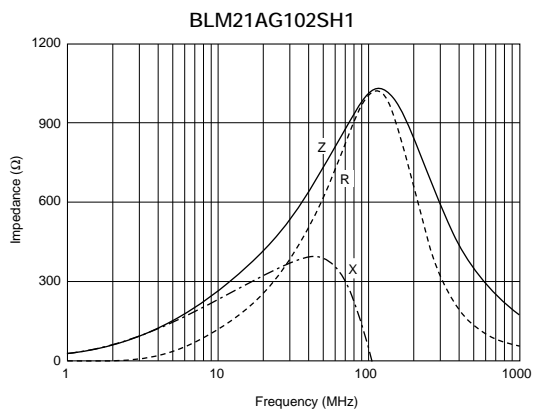
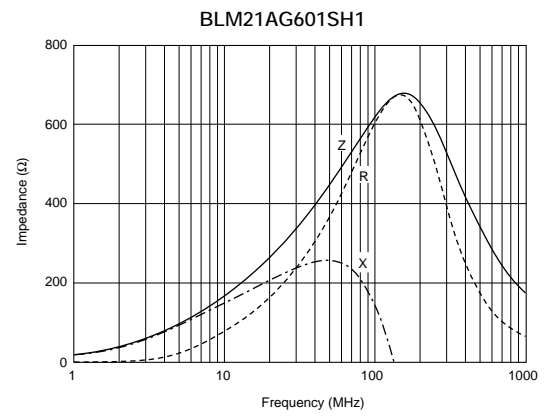
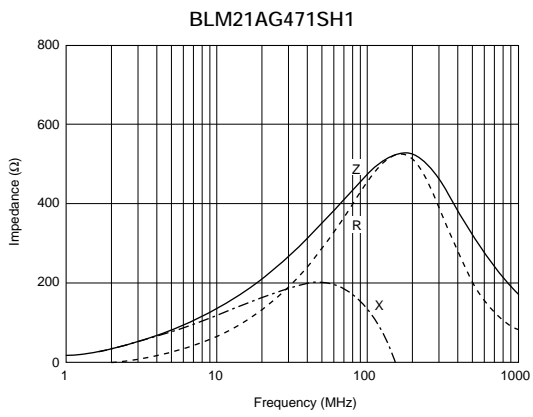
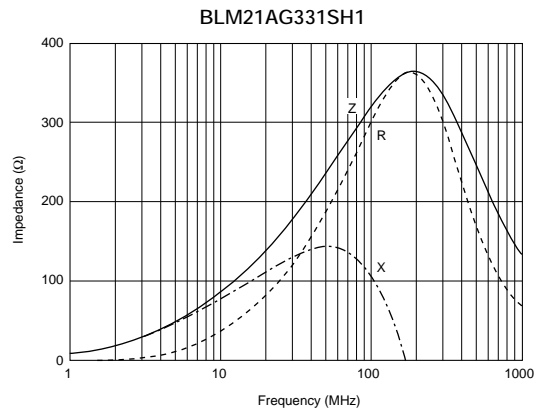
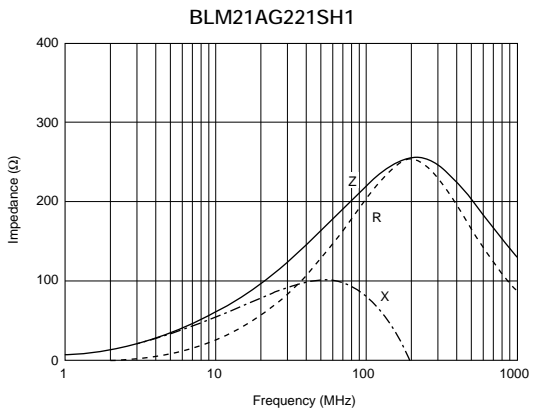

BLM31A Series

■ Features

The chip ferrite beads BLM series is designed to function nearly as a resistor at noise frequencies, which greatly reduces the possibility of resonance and leaves signal wave forms undistorted.

BLM series is effective in circuits without stable ground lines because BLM series does not need a connection to ground.

The nickel barrier structure of the external electrodes provides excellent solder heat resistance. BLM_A series generates an impedance from the relatively low frequencies. Therefore BLM_A series is effective in noise suppression in a wide frequency range (30MHz to several hundred MHz).

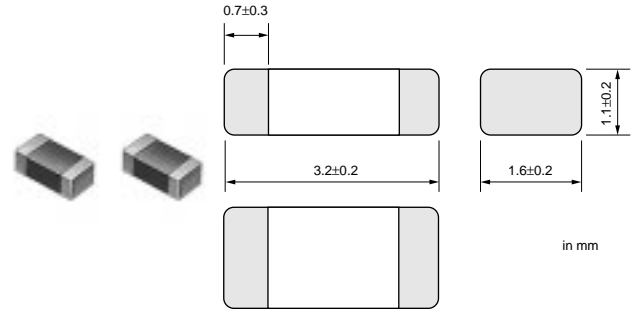

Part Number	Impedance (at 100MHz/20°C) (ohm)	Rated Current (mA)	DC Resistance (max.) (ohm)	Operating Temperature Range (°C)
BLM31AJ601SH1	600 ±25%	200	0.90	-55 to +125

■ Equivalent Circuit

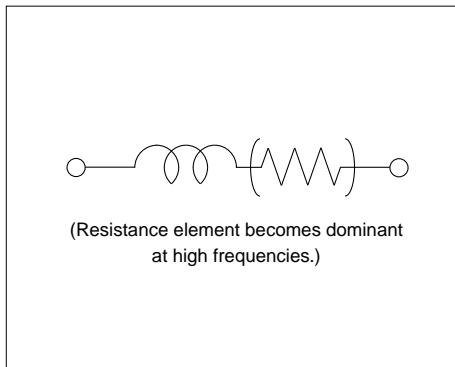

■ Impedance - Frequency Characteristics

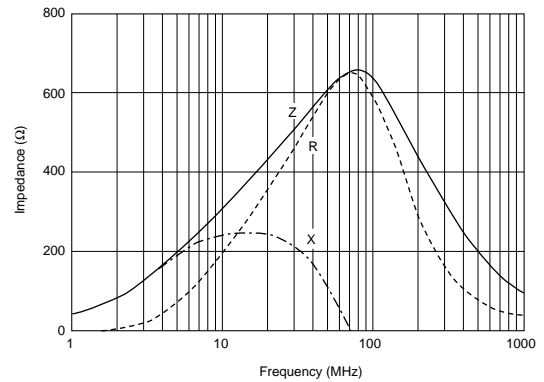

BLM15B Series

■ Features

The chip ferrite beads BLM series is designed to function nearly as a resistor at noise frequencies, which greatly reduces the possibility of resonance and leaves signal wave forms undistorted.

BLM series is effective in circuits without stable ground lines because BLM series does not need a connection to ground.

The nickel barrier structure of the external electrodes provides excellent solder heat resistance. BLM_B series can minimize attenuation of the signal waveform due to its sharp impedance characteristics. Various impedances are available to match signal frequency.

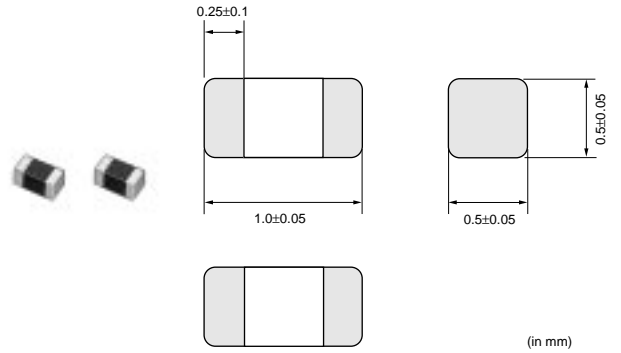

Part Number	Impedance (at 100MHz/20°C) (ohm)	Rated Current (mA)	DC Resistance (max.) (ohm)	Operating Temperature Range (°C)
BLM15BB050SH1	5 ±25%	500	0.08	-55 to +125
BLM15BB100SH1	10 ±25%	300	0.10	-55 to +125
BLM15BB220SH1	22 ±25%	300	0.20	-55 to +125
BLM15BB470SH1	47 ±25%	300	0.35	-55 to +125
BLM15BB750SH1	75 ±25%	300	0.40	-55 to +125
BLM15BB121SH1	120 ±25%	300	0.55	-55 to +125
BLM15BB221SH1	220 ±25%	200	0.80	-55 to +125
BLM15BD471SH1	470 ±25%	200	0.60	-55 to +125
BLM15BD601SH1	600 ±25%	200	0.65	-55 to +125
BLM15BD102SH1	1000 ±25%	200	0.90	-55 to +125
BLM15BD182SH1	1800 ±25%	200	1.40	-55 to +125

■ Equivalent Circuit

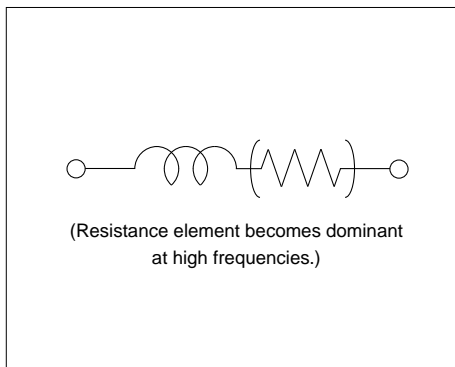

■ Impedance - Frequency (Typical)

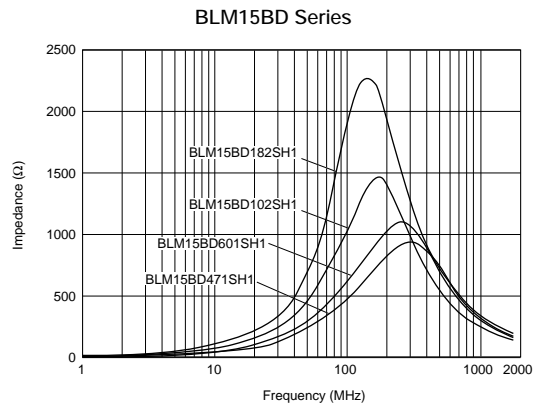
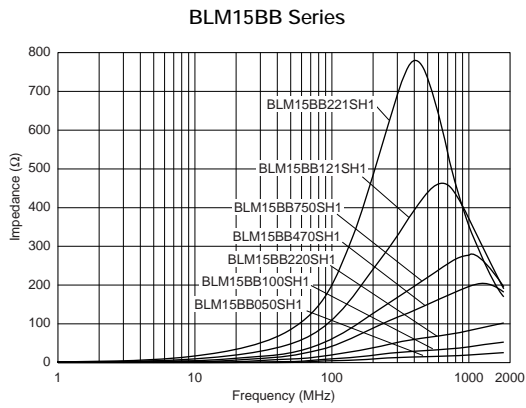

■ Impedance - Frequency Characteristics

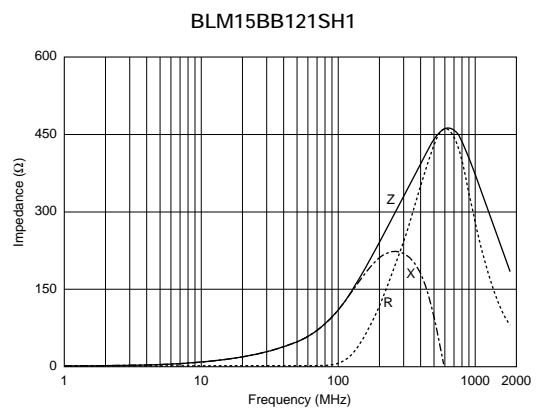
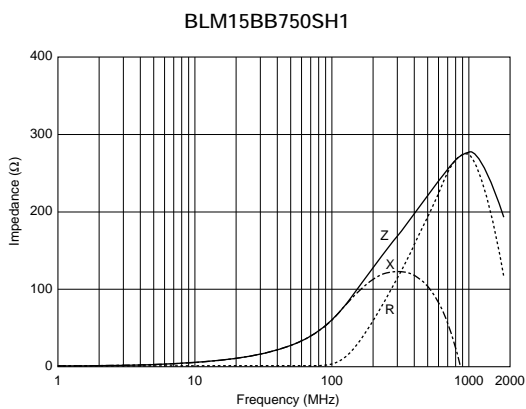
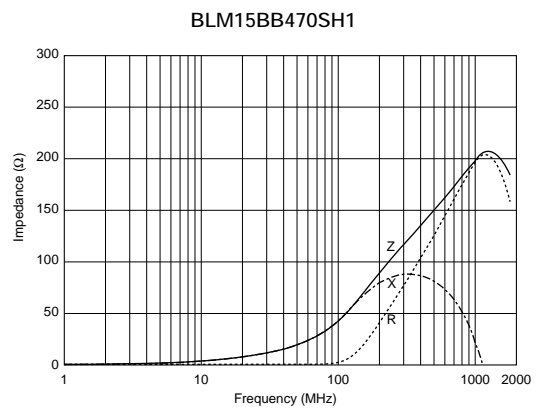
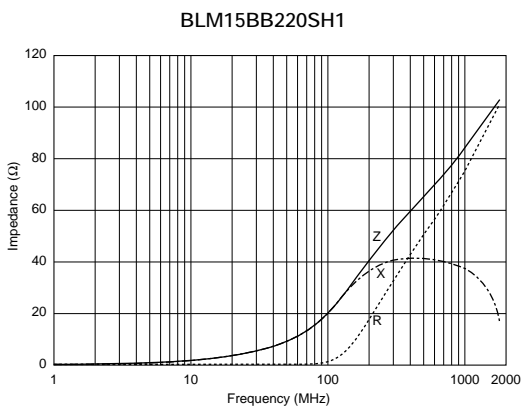
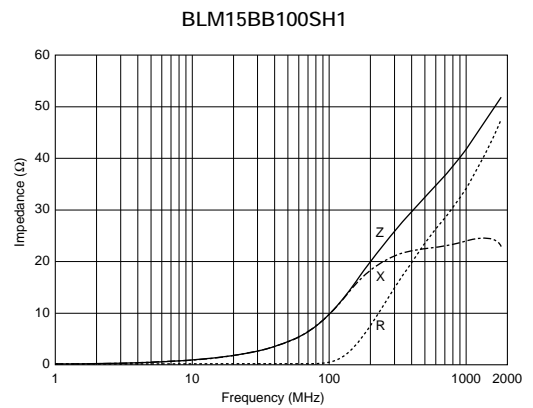
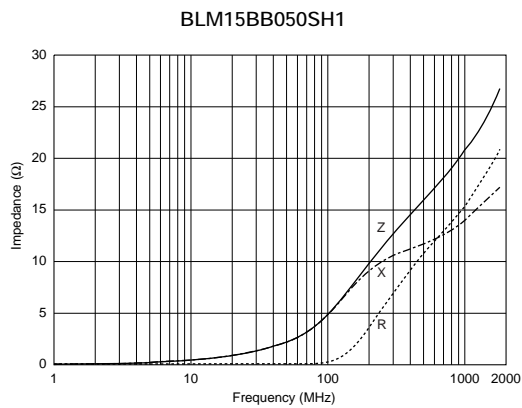

Continued on the following page.

Continued from the preceding page.

■ Impedance - Frequency Characteristics

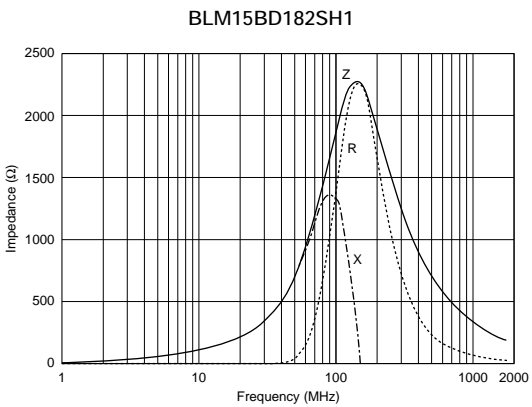
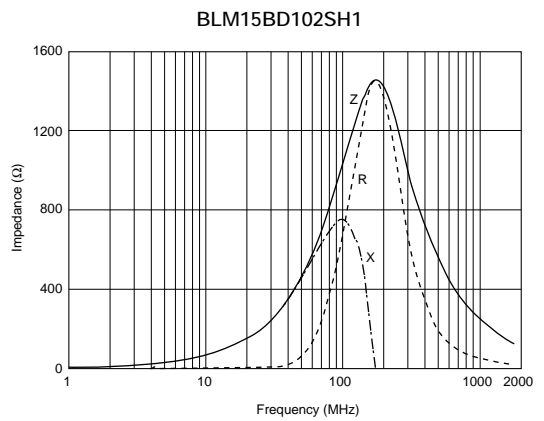
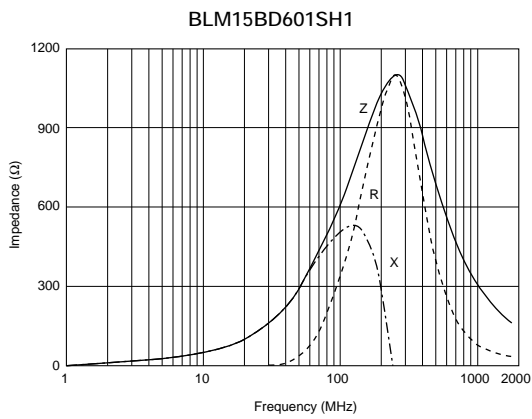
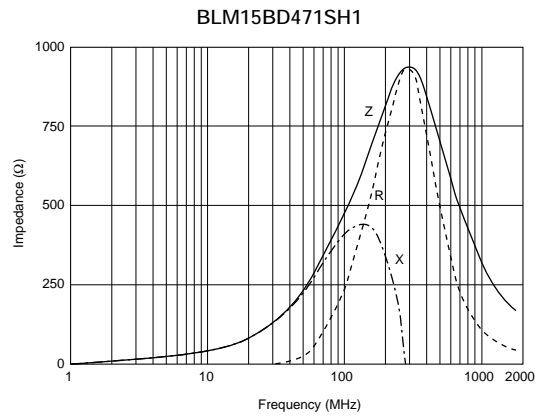
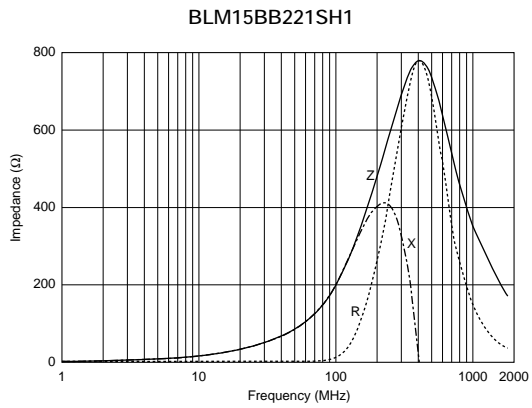

BLM18B Series

■ Features

The chip ferrite beads BLM series is designed to function nearly as a resistor at noise frequencies, which greatly reduces the possibility of resonance and leaves signal wave forms undistorted.

BLM series is effective in circuits without stable ground lines because BLM series does not need a connection to ground.

The nickel barrier structure of the external electrodes provides excellent solder heat resistance.

BLM_B series can minimize attenuation of the signal waveform due to its sharp impedance characteristics.

Various impedances are available to match signal frequency.

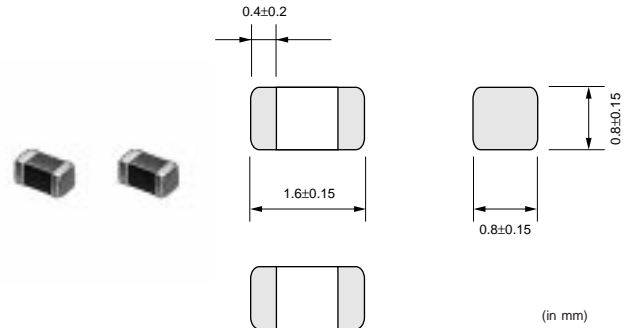

Part Number	Impedance (at 100MHz/20°C) (ohm)	Rated Current (mA)	DC Resistance (max.) (ohm)	Operating Temperature Range (°C)
BLM18BA050SH1	5 ±25%	500	0.20	-55 to +125
BLM18BB050SH1	5 ±25%	700	0.05	-55 to +125
BLM18BA100SH1	10 ±25%	500	0.25	-55 to +125
BLM18BB100SH1	10 ±25%	700	0.10	-55 to +125
BLM18BA220SH1	22 ±25%	500	0.35	-55 to +125
BLM18BB220SH1	22 ±25%	600	0.20	-55 to +125
BLM18BA470SH1	47 ±25%	300	0.55	-55 to +125
BLM18BB470SH1	47 ±25%	550	0.25	-55 to +125
BLM18BD470SH1	47 ±25%	500	0.30	-55 to +125
BLM18BB600SH1	60 ±25%	550	0.25	-55 to +125
BLM18BA750SH1	75 ±25%	300	0.70	-55 to +125
BLM18BB750SH1	75 ±25%	500	0.30	-55 to +125
BLM18BA121SH1	120 ±25%	200	0.90	-55 to +125
BLM18BB121SH1	120 ±25%	500	0.30	-55 to +125
BLM18BD121SH1	120 ±25%	200	0.40	-55 to +125
BLM18BB141SH1	140 ±25%	450	0.35	-55 to +125
BLM18BB151SH1	150 ±25%	450	0.37	-55 to +125
BLM18BD151SH1	150 ±25%	200	0.40	-55 to +125
BLM18BB221SH1	220 ±25%	450	0.45	-55 to +125
BLM18BD221SH1	220 ±25%	200	0.45	-55 to +125
BLM18BB331SH1	330 ±25%	400	0.58	-55 to +125
BLM18BD331SH1	330 ±25%	200	0.50	-55 to +125
BLM18BD421SH1	420 ±25%	200	0.55	-55 to +125
BLM18BB471SH1	470 ±25%	300	0.85	-55 to +125
BLM18BD471SH1	470 ±25%	200	0.55	-55 to +125
BLM18BD601SH1	600 ±25%	200	0.65	-55 to +125
BLM18BD102SH1	1000 ±25%	100	0.85	-55 to +125
BLM18BD152SH1	1500 ±25%	50	1.20	-55 to +125
BLM18BD182SH1	1800 ±25%	50	1.50	-55 to +125
BLM18BD222SH1	2200 ±25%	50	1.50	-55 to +125
BLM18BD252SH1	2500 ±25%	50	1.50	-55 to +125

■ Equivalent Circuit

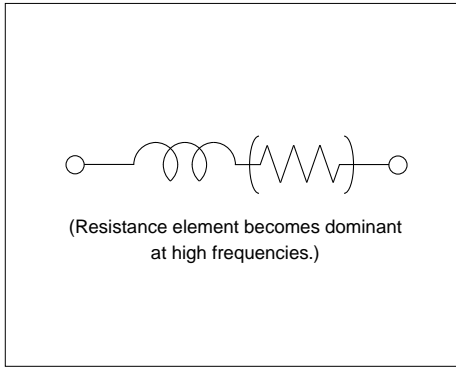

■ Impedance - Frequency (Typical)

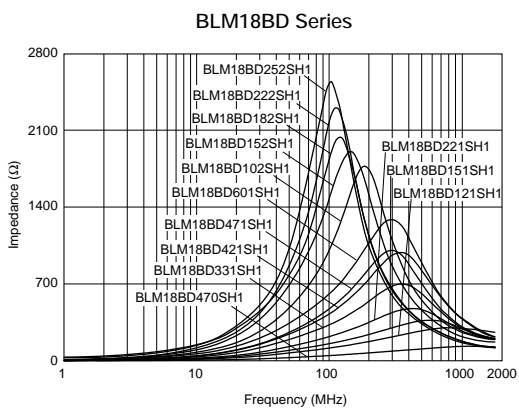
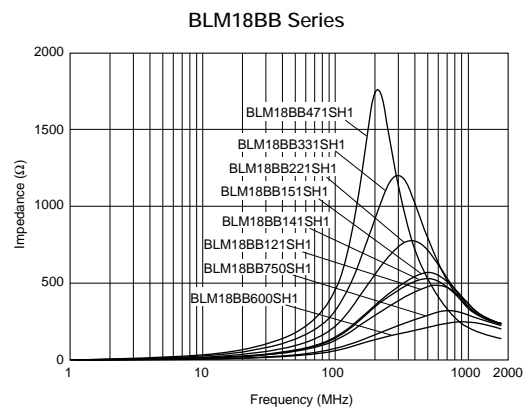
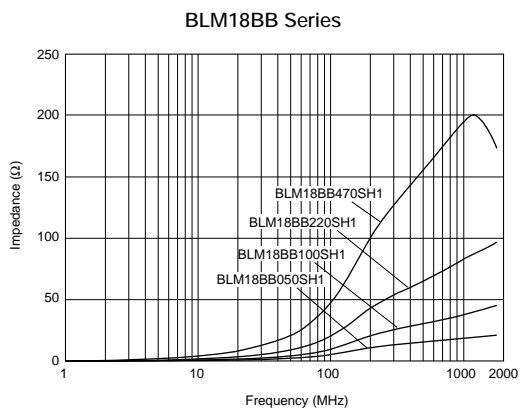
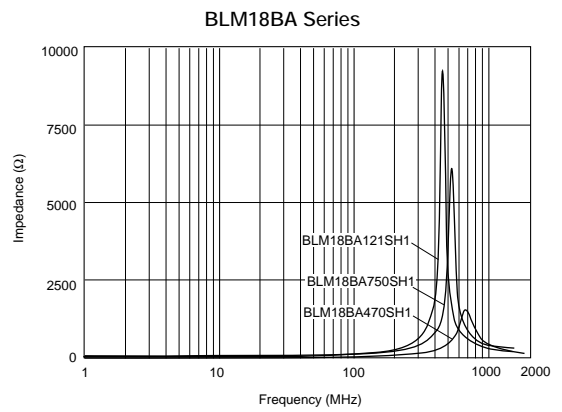
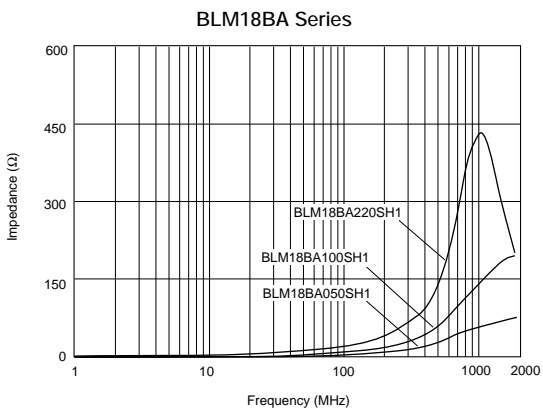

■ Impedance - Frequency Characteristics

BLM18BA050SH1

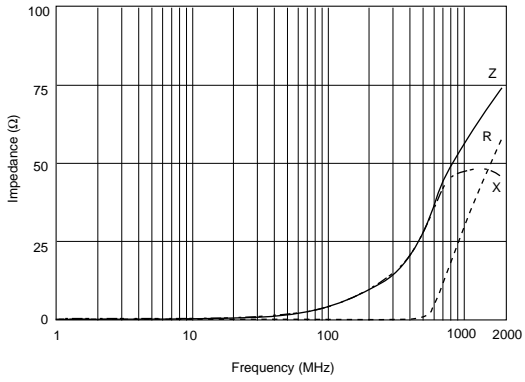

BLM18BB050SH1

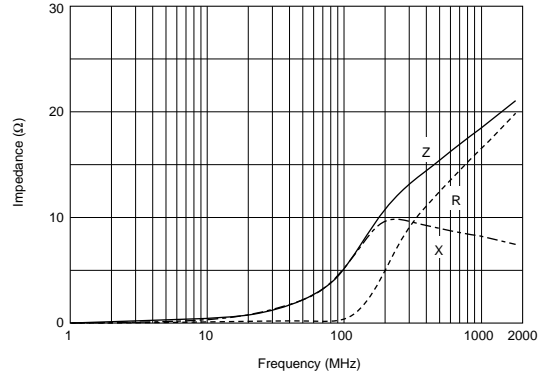

BLM18BA100SH1

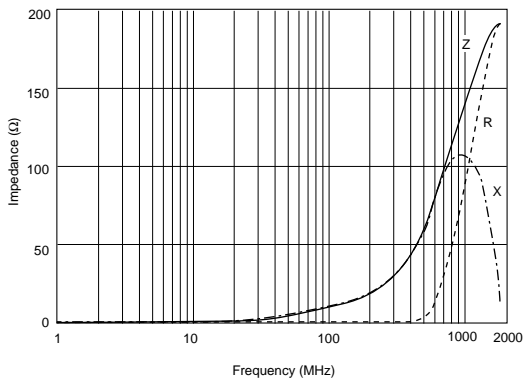

BLM18BB100SH1

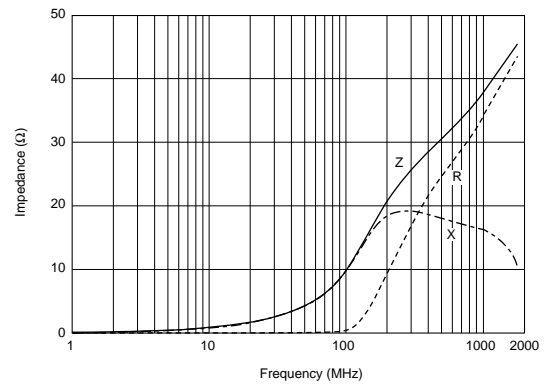

BLM18BA220SH1

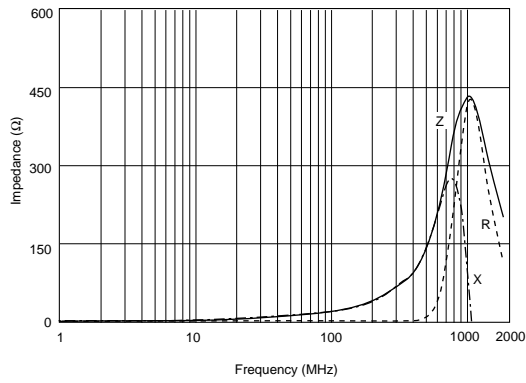

BLM18BB220SH1

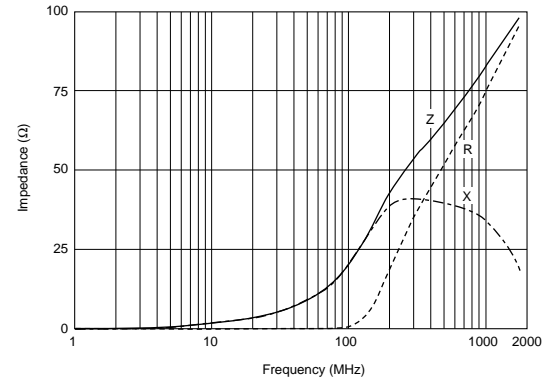

BLM18BA470SH1

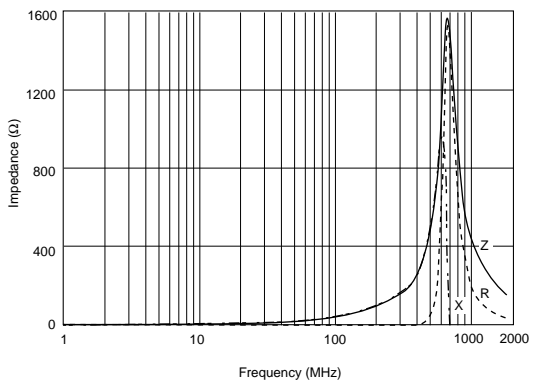

BLM18BB470SH1

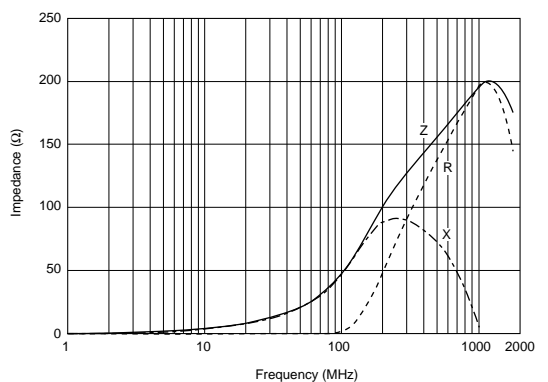

Continued from the preceding page.

Impedance - Frequency Characteristics

BLM18BD470SH1

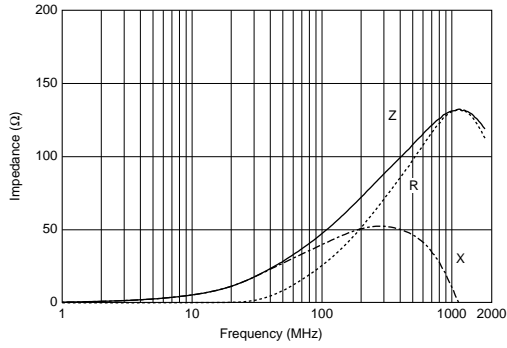

BLM18BB600SH1

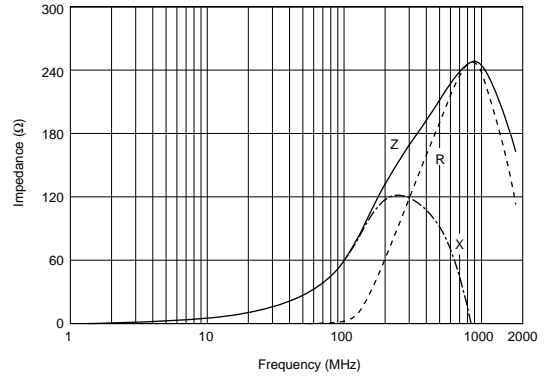

BLM18BA750SH1

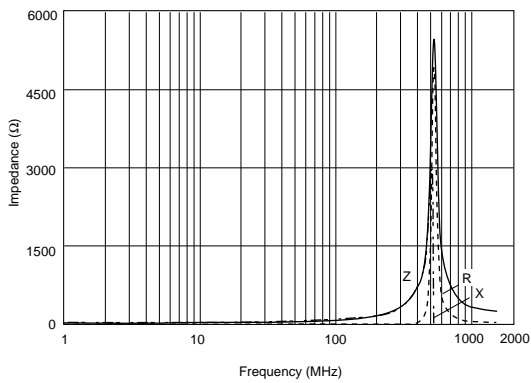

BLM18BB750SH1

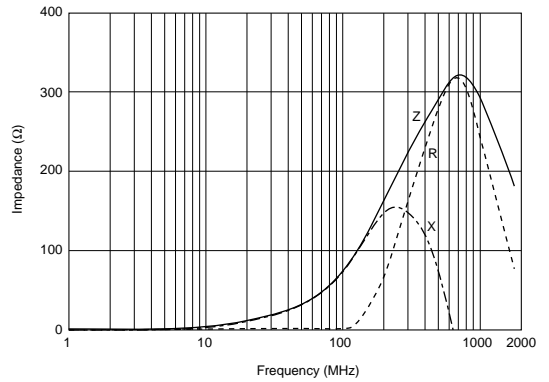

BLM18BA121SH1

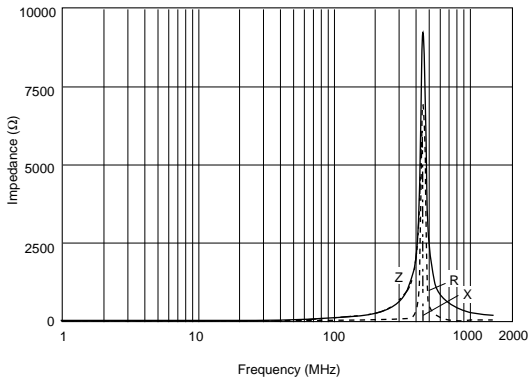

BLM18BB121SH1

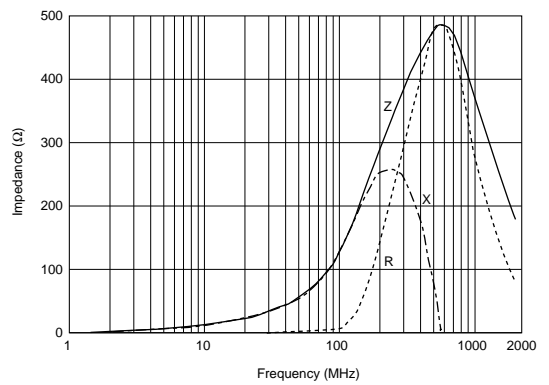

BLM18BD121SH1

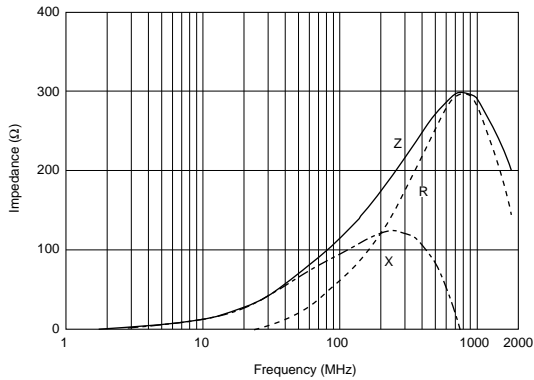

BLM18BB141SH1

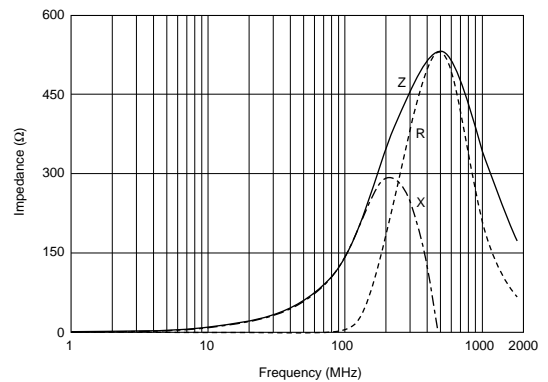

Continued on the following page. ↗

Continued from the preceding page.

■ Impedance - Frequency Characteristics

1

BLM18BB151SH1

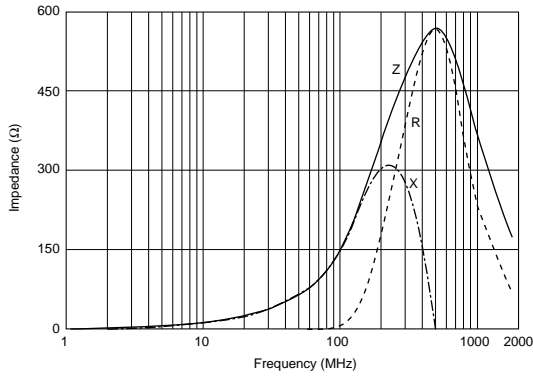

BLM18BD151SH1

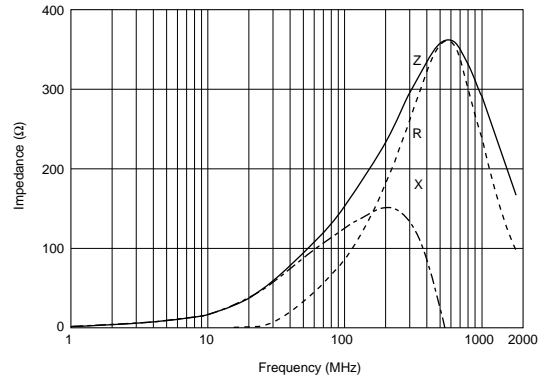

BLM18BB221SH1

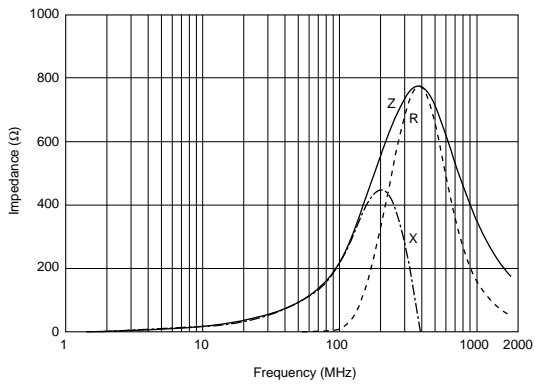

BLM18BD221SH1

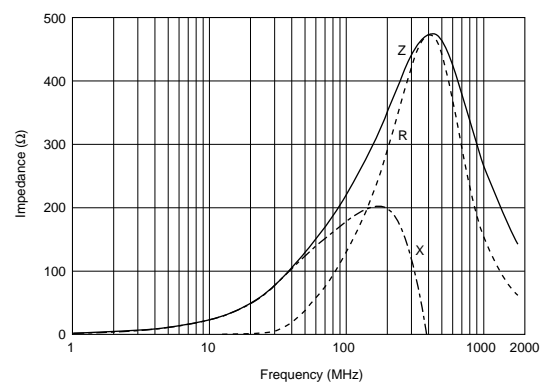

BLM18BB331SH1

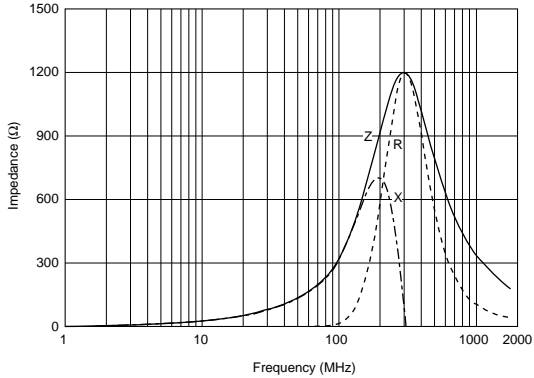

BLM18BD331SH1

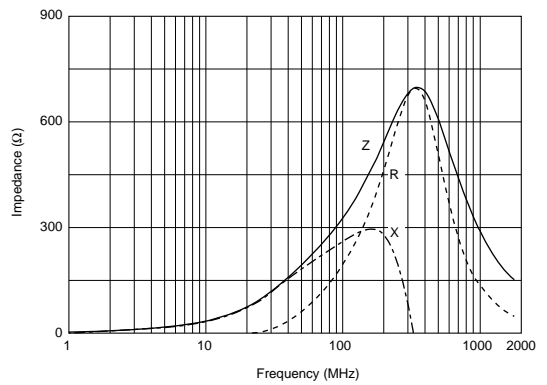

BLM18BD421SH1

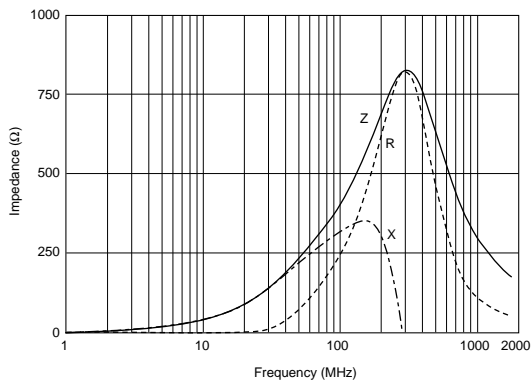

BLM18BB471SH1

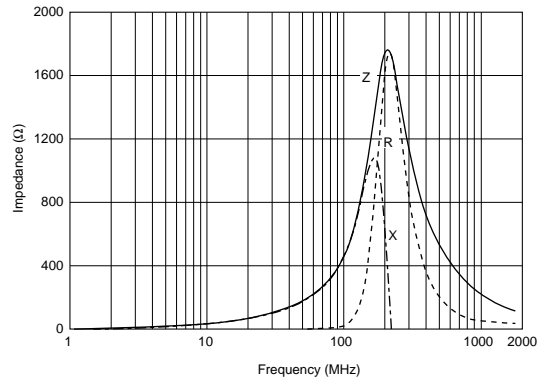

Continued on the following page. ↗

Continued from the preceding page.

Impedance - Frequency Characteristics

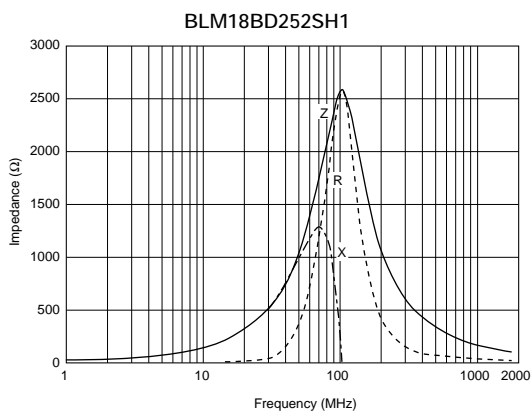
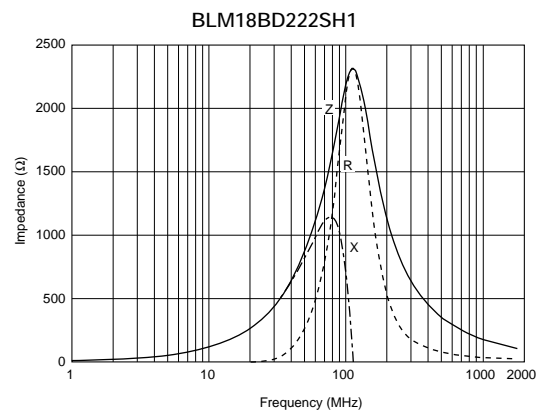
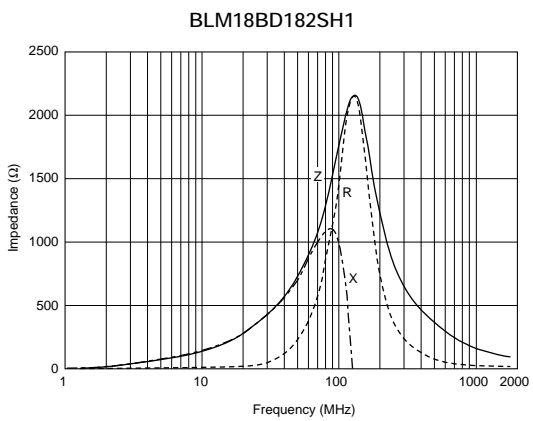
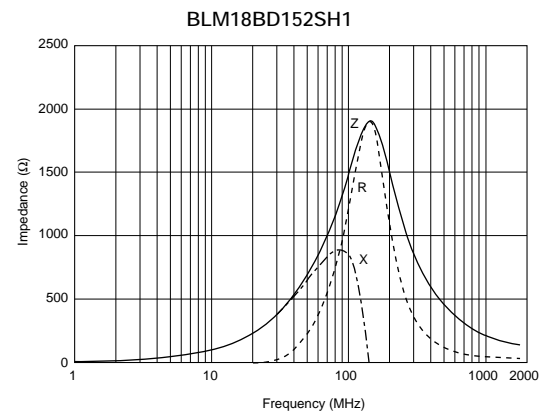
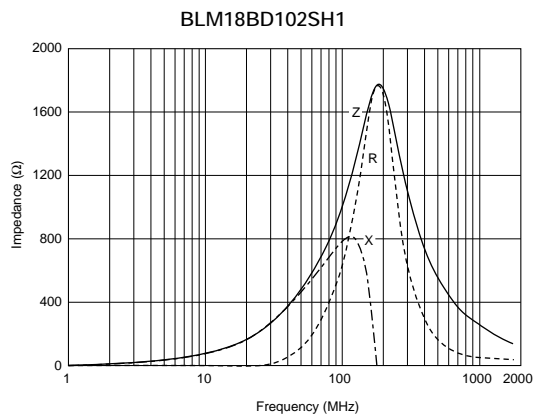
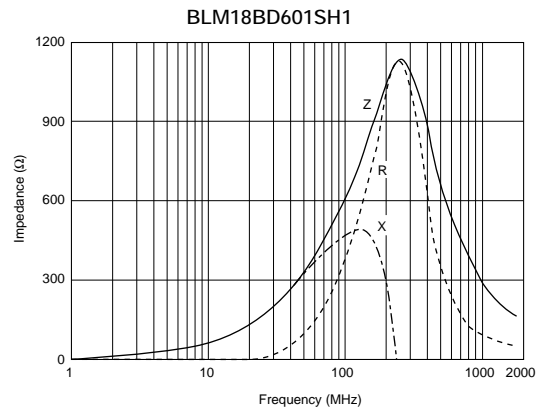
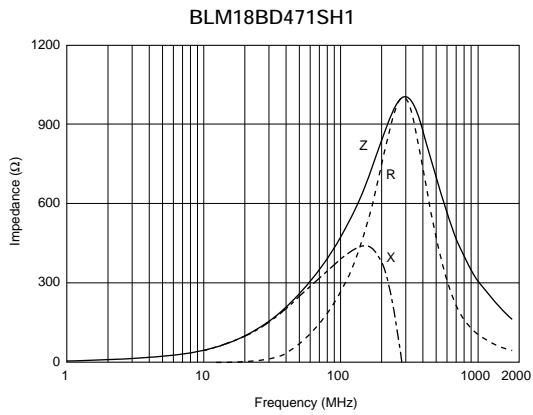

BLM21B Series

■ Features

The chip ferrite beads BLM series is designed to function nearly as a resistor at noise frequencies, which greatly reduces the possibility of resonance and leaves signal wave forms undistorted.

BLM series is effective in circuits without stable ground lines because BLM series does not need a connection to ground.

The nickel barrier structure of the external electrodes provides excellent solder heat resistance. BLM_B series can minimize attenuation of the signal waveform due to its sharp impedance characteristics. Various impedances are available to match signal frequency.

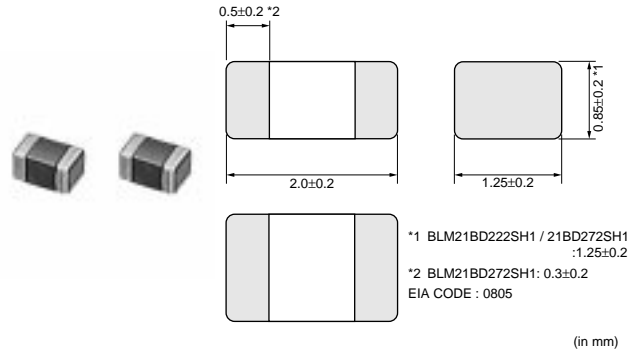

Part Number	Impedance (at 100MHz/20°C) (ohm)	Rated Current (mA)	DC Resistance (max.) (ohm)	Operating Temperature Range (°C)
BLM21BB050SH1	5 ±25%	500	0.07	-55 to +125
BLM21BB600SH1	60 ±25%	200	0.20	-55 to +125
BLM21BB750SH1	75 ±25%	200	0.25	-55 to +125
BLM21BB121SH1	120 ±25%	200	0.25	-55 to +125
BLM21BD121SH1	120 ±25%	200	0.25	-55 to +125
BLM21BB151SH1	150 ±25%	200	0.25	-55 to +125
BLM21BD151SH1	150 ±25%	200	0.25	-55 to +125
BLM21BB201SH1	200 ±25%	200	0.35	-55 to +125
BLM21BB221SH1	220 ±25%	200	0.35	-55 to +125
BLM21BD221SH1	220 ±25%	200	0.25	-55 to +125
BLM21BB331SH1	330 ±25%	200	0.40	-55 to +125
BLM21BD331SH1	330 ±25%	200	0.30	-55 to +125
BLM21BD421SH1	420 ±25%	200	0.30	-55 to +125
BLM21BB471SH1	470 ±25%	200	0.45	-55 to +125
BLM21BD471SH1	470 ±25%	200	0.35	-55 to +125
BLM21BD601SH1	600 ±25%	200	0.35	-55 to +125
BLM21BD751SH1	750 ±25%	200	0.40	-55 to +125
BLM21BD102SH1	1000 ±25%	200	0.40	-55 to +125
BLM21BD152SH1	1500 ±25%	200	0.45	-55 to +125
BLM21BD182SH1	1800 ±25%	200	0.50	-55 to +125
BLM21BD222TH1	2200 ±25%	200	0.60	-55 to +125
BLM21BD222SH1	2250 (Typ.)	200	0.60	-55 to +125
BLM21BD272SH1	2700 ±25%	200	0.80	-55 to +125

■ Equivalent Circuit

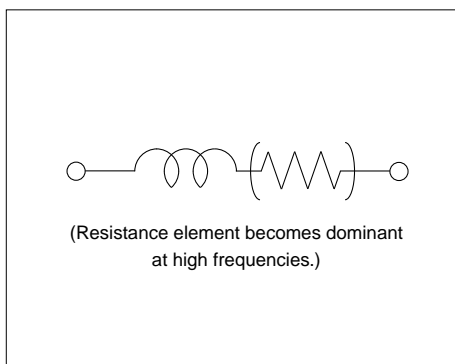

1

■ Impedance - Frequency (Typical)

BLM21BB Series

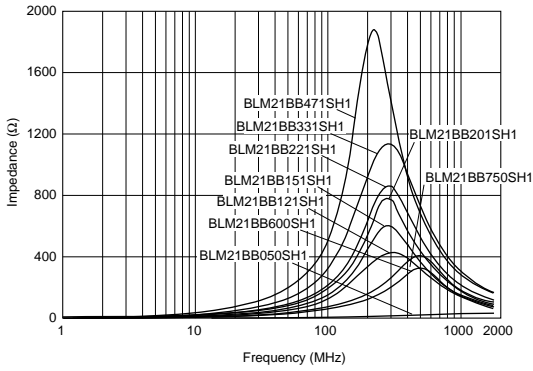

BLM21BD Series

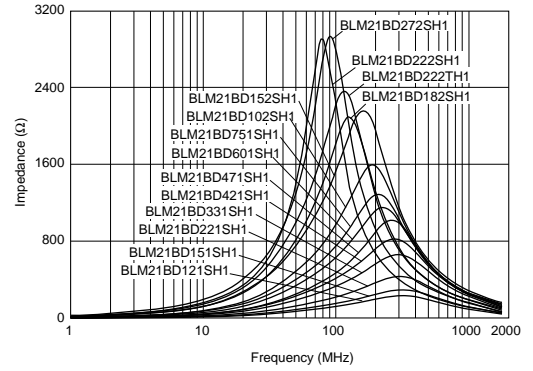

■ Impedance - Frequency Characteristics

BLM21BB050SH1

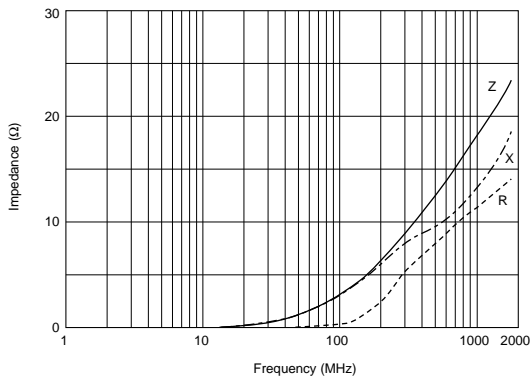

BLM21BB600SH1

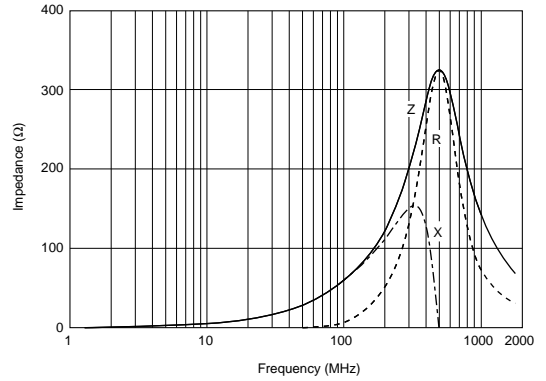

BLM21BB750SH1

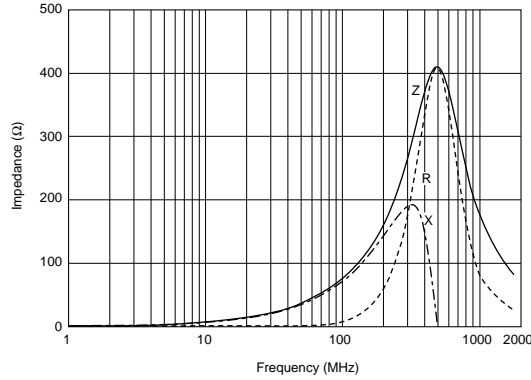

BLM21BB121SH1

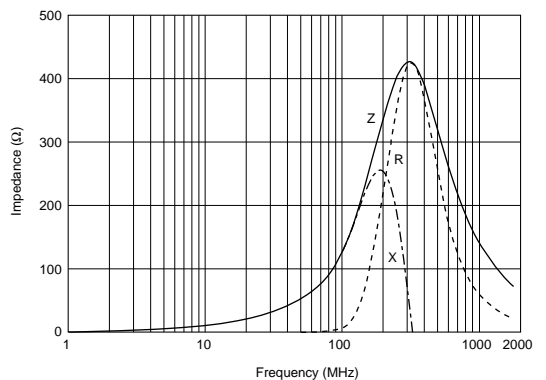

BLM21BD121SH1

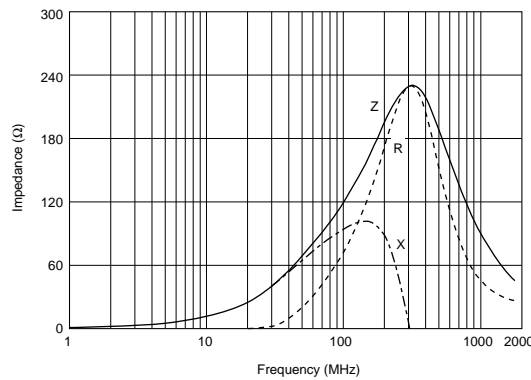

BLM21BB151SH1

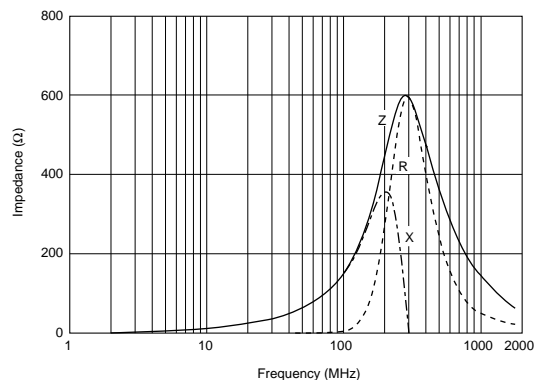

Continued on the following page. ↗

↳ Continued from the preceding page.

■ Impedance - Frequency Characteristics

1

BLM21BD151SH1

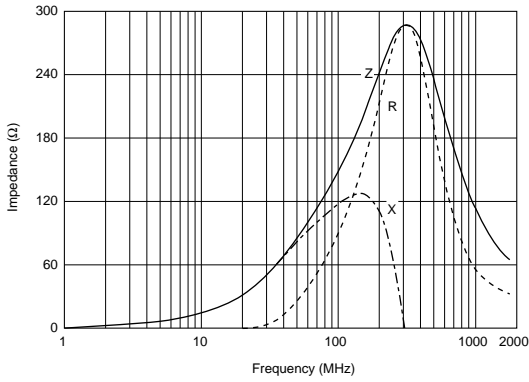

BLM21BB201SH1

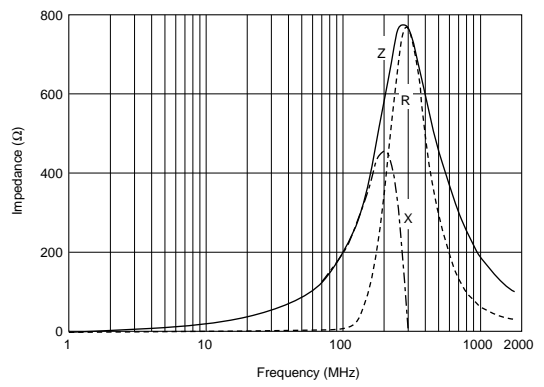

BLM21BB221SH1

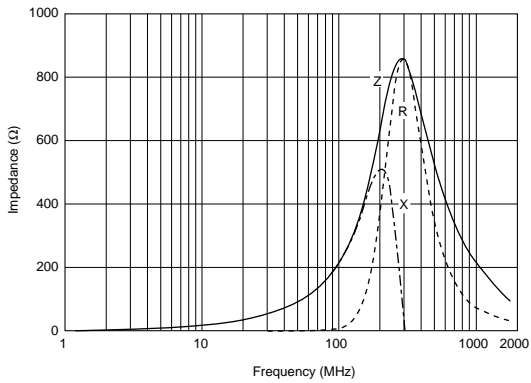

BLM21BD221SH1

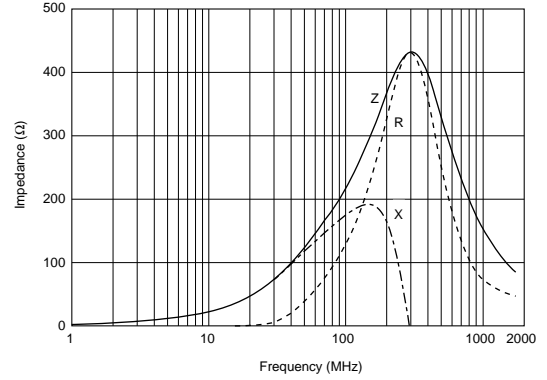

BLM21BB331SH1

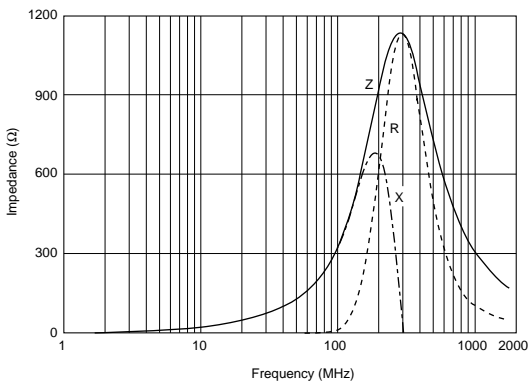

BLM21BD331SH1

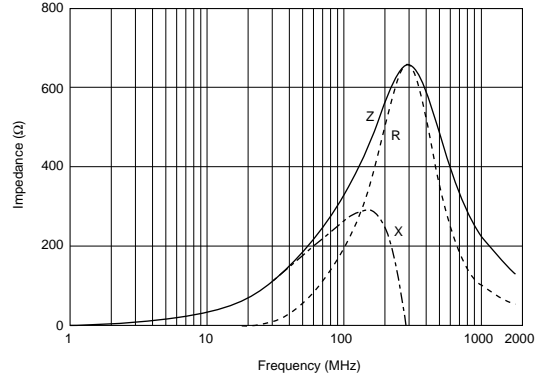

BLM21BD421SH1

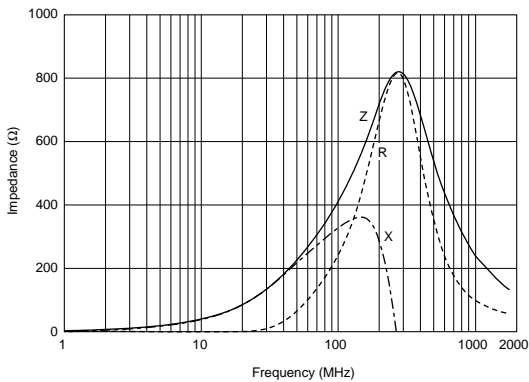

BLM21BB471SH1

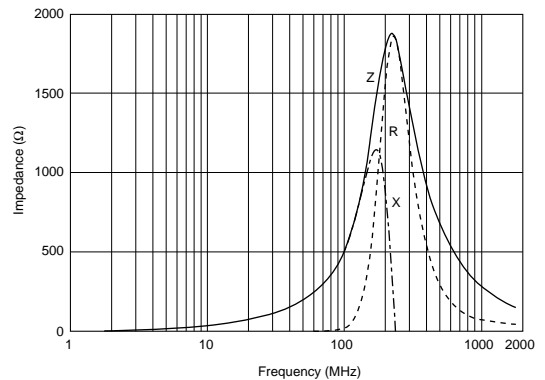

Continued on the following page. ↗

Continued from the preceding page.

Impedance - Frequency Characteristics

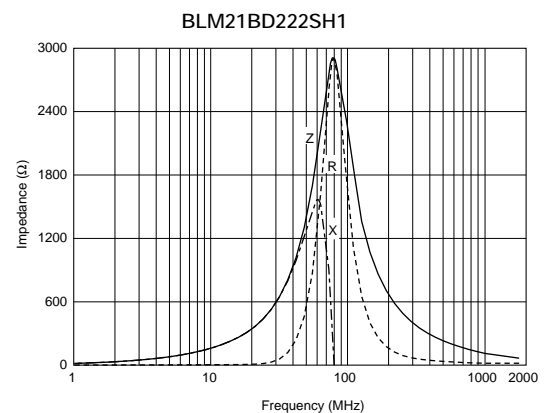
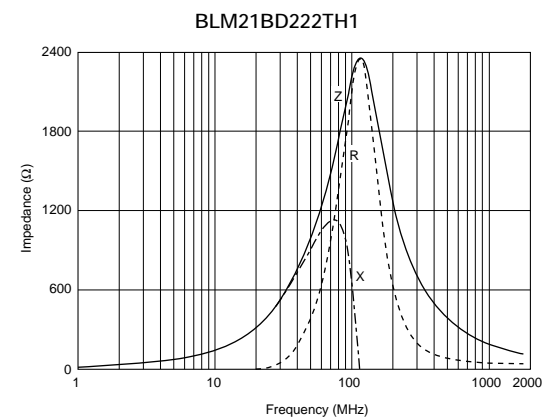
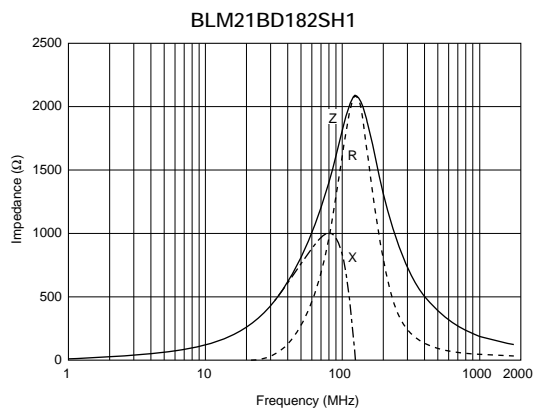
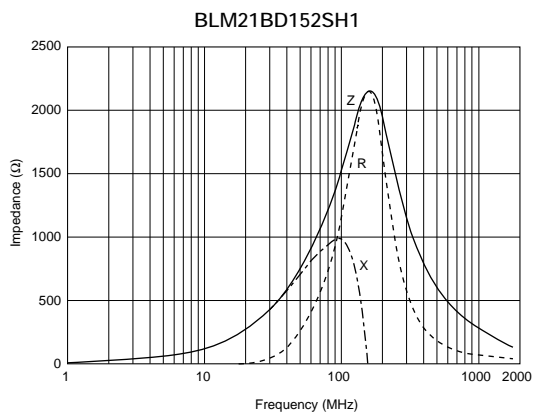
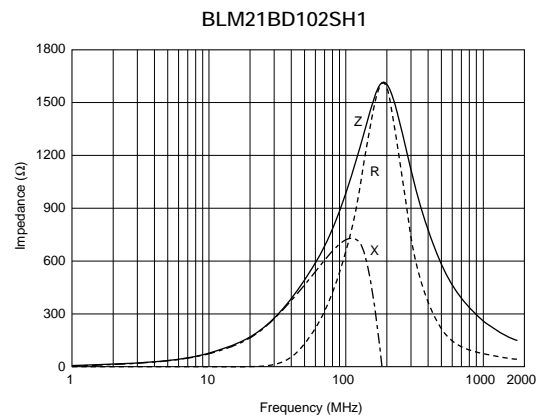
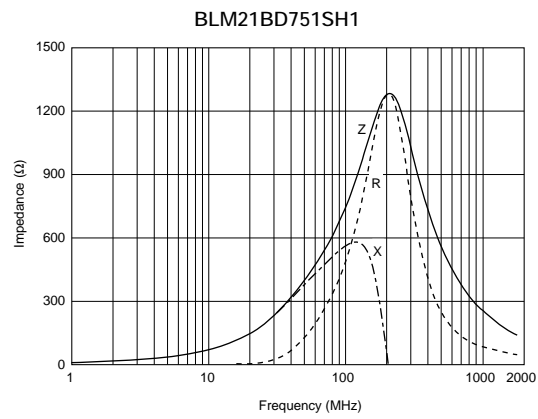
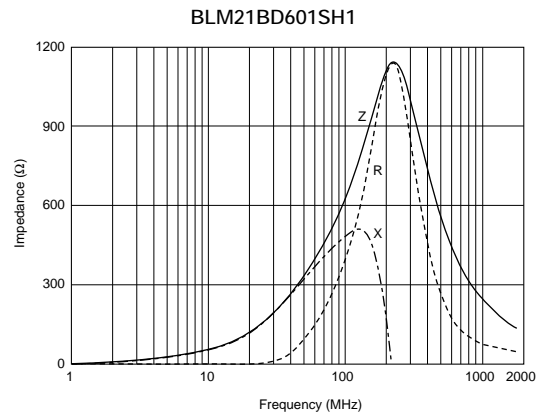
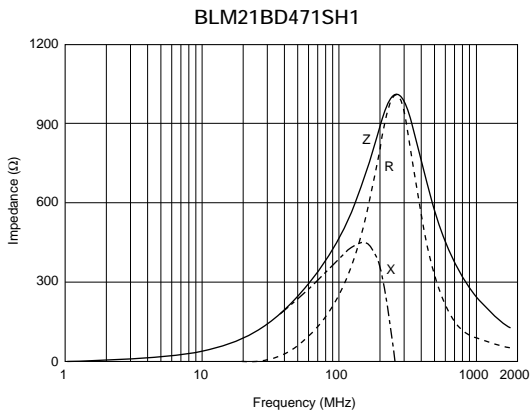

Continued on the following page. ↗

Continued from the preceding page.

■ Impedance - Frequency Characteristics

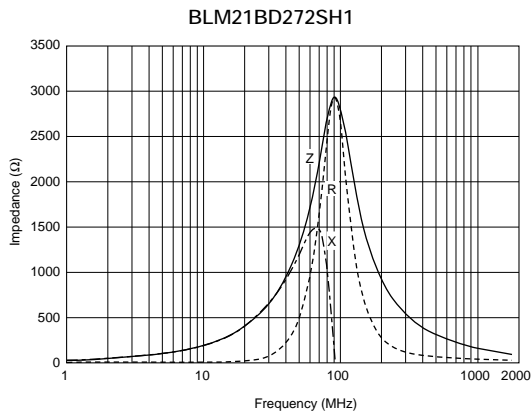

1

BLM18P Series

■ Features

The chip ferrite beads BLM series is designed to function nearly as a resistor at noise frequencies, which greatly reduces the possibility of resonance and leaves signal wave forms undistorted.

BLM series is effective in circuits without stable ground lines because BLM series does not need a connection to ground.

The nickel barrier structure of the external electrodes provides excellent solder heat resistance. BLM_P series can be used in high current circuits due to its low DC resistance.

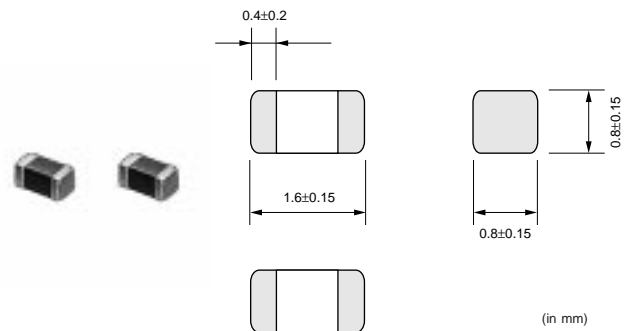

Part Number	Impedance (at 100MHz/20°C) (ohm)	Rated Current (mA)	DC Resistance (max.) (ohm)	Operating Temperature Range (°C)
BLM18PG300SH1	30 (Typ.)	1000	0.05	-55 to +125
BLM18PG330SH1	33 ±25%	3000	0.025	-55 to +125
BLM18PG600SH1	60 (Typ.)	500	0.10	-55 to +125
BLM18PG121SH1	120 ±25%	2000	0.05	-55 to +125
BLM18PG181SH1	180 ±25%	1500	0.09	-55 to +125
BLM18PG221SH1	220 ±25%	1400	0.10	-55 to +125
BLM18PG331SH1	330 ±25%	1200	0.15	-55 to +125
BLM18PG471SH1	470 ±25%	1000	0.20	-55 to +125

For the items of rated current higher than 1200mA, derating is required.
 Please refer to p.32, "Derating of Rated Current".

■ Equivalent Circuit

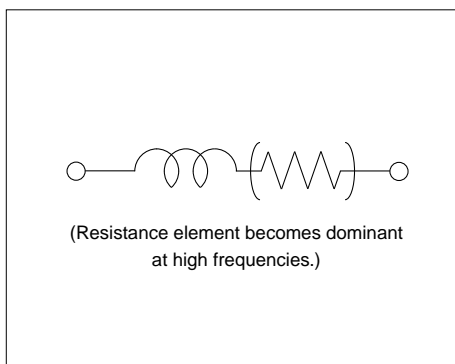

■ Impedance - Frequency (Typical)

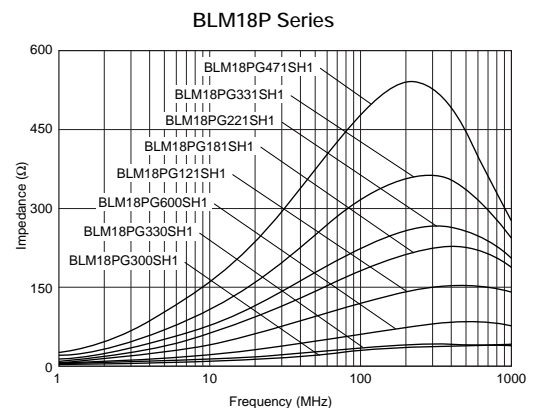

1

■ Impedance - Frequency Characteristics

BLM18PG300SH1

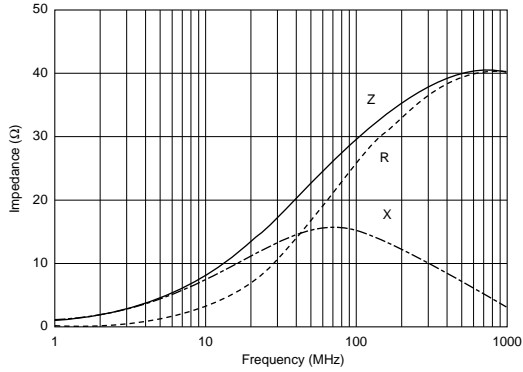

BLM18PG330SH1

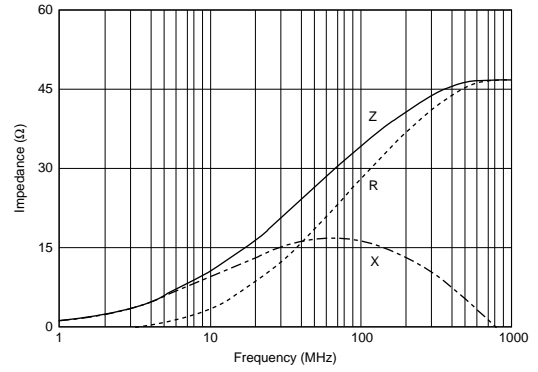

BLM18PG600SH1

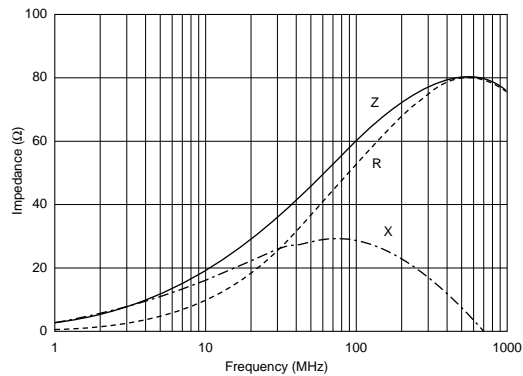

BLM18PG121SH1

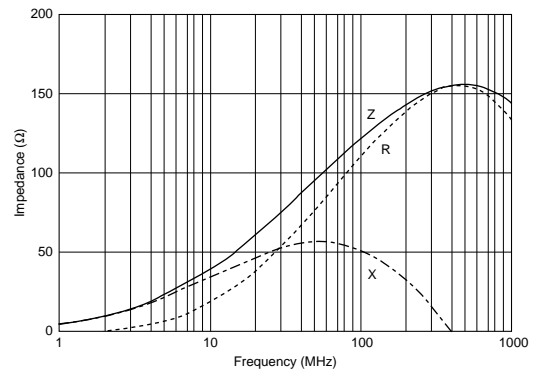

BLM18PG181SH1

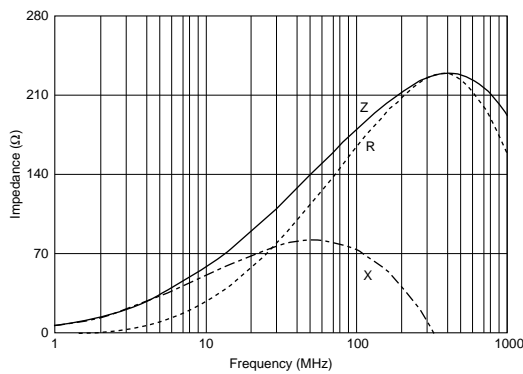

BLM18PG221SH1

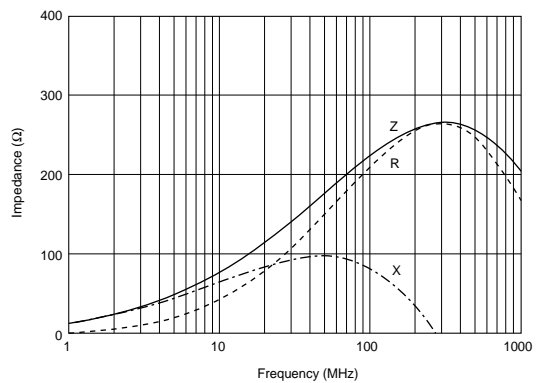

BLM18PG331SH1

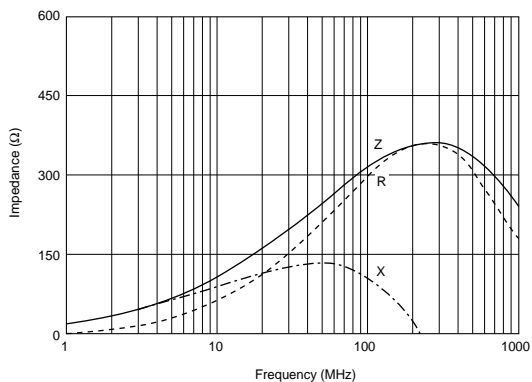

BLM18PG471SH1

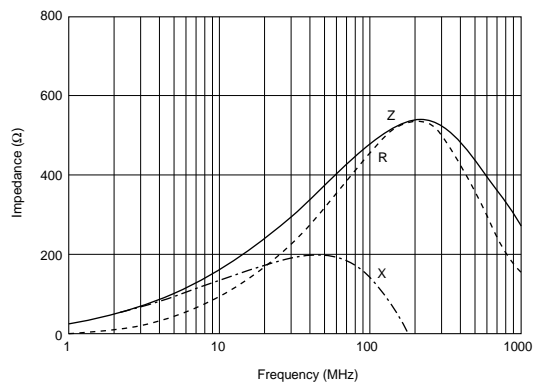

BLM21P Series

■ Features

The chip ferrite beads BLM series is designed to function nearly as a resistor at noise frequencies, which greatly reduces the possibility of resonance and leaves signal wave forms undistorted.

BLM series is effective in circuits without stable ground lines because BLM series does not need a connection to ground.

The nickel barrier structure of the external electrodes provides excellent solder heat resistance. BLM_P series can be used in high current circuits due to its low DC resistance.

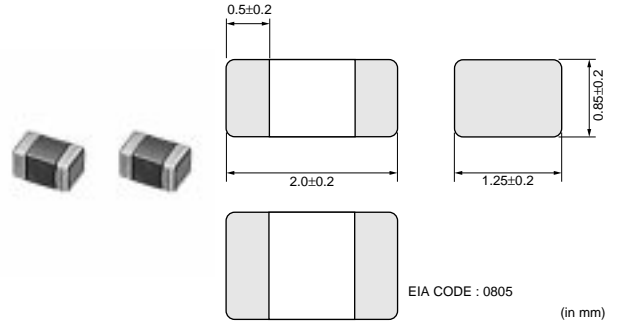

Part Number	Impedance (at 100MHz/20°C) (ohm)	Rated Current (mA)	DC Resistance (max.) (ohm)	Operating Temperature Range (°C)
BLM21PG220SH1	22 ±25%	6000	0.01	-55 to +125
BLM21PG300SH1	30 (Typ.)	3000	0.015	-55 to +125
BLM21PG600SH1	60 ±25%	3000	0.025	-55 to +125
BLM21PG221SH1	220 ±25%	2000	0.050	-55 to +125
BLM21PG331SH1	330 ±25%	1500	0.09	-55 to +125

For the items of rated current higher than 1500mA, derating is required. Please refer to p.32, "Derating of Rated Current".

■ Equivalent Circuit

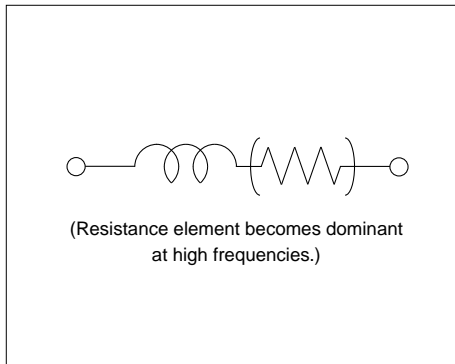

■ Impedance - Frequency (Typical)

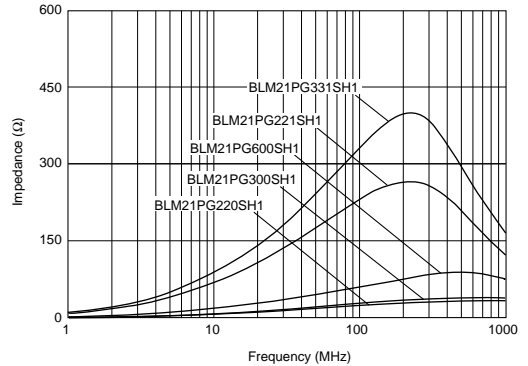

■ Impedance - Frequency Characteristics

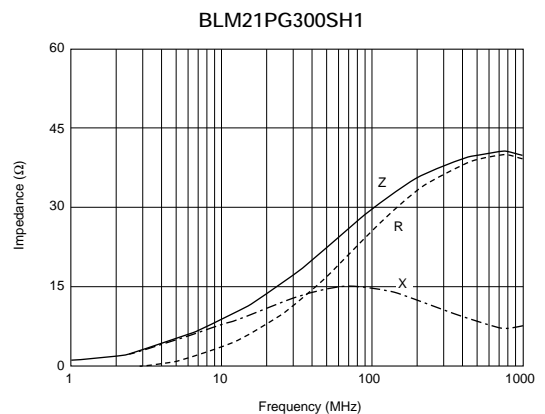
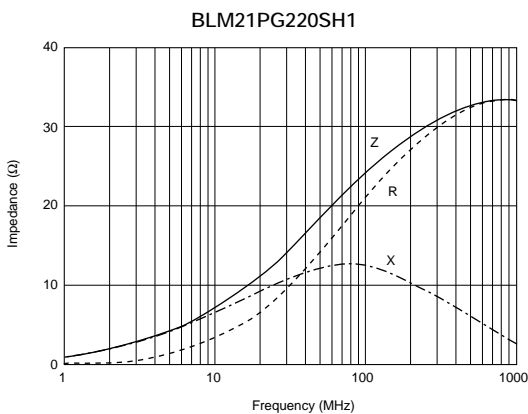

Continued on the following page. ↗

Continued from the preceding page.

Impedance - Frequency Characteristics

BLM21PG600SH1

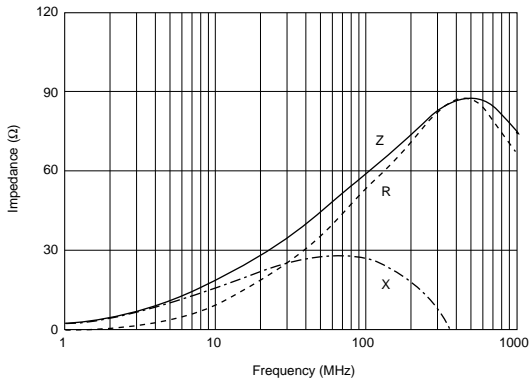

BLM21PG221SH1

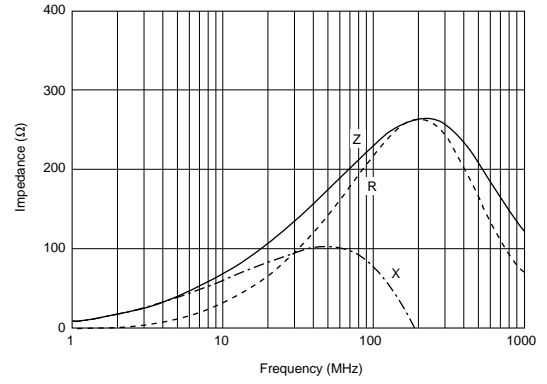

BLM21PG331SH1

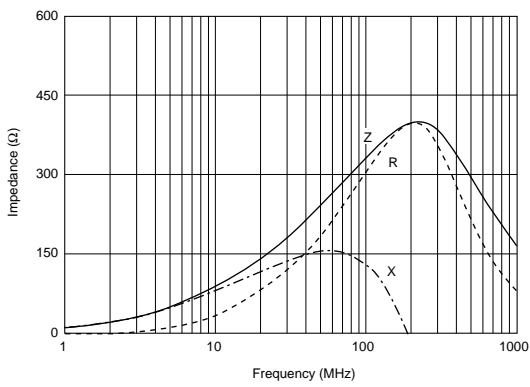

BLM31P Series

■ Features

The chip ferrite beads BLM series is designed to function nearly as a resistor at noise frequencies, which greatly reduces the possibility of resonance and leaves signal wave forms undistorted.

BLM series is effective in circuits without stable ground lines because BLM series does not need a connection to ground.

The nickel barrier structure of the external electrodes provides excellent solder heat resistance. BLM_P series can be used in high current circuits due to its low DC resistance.

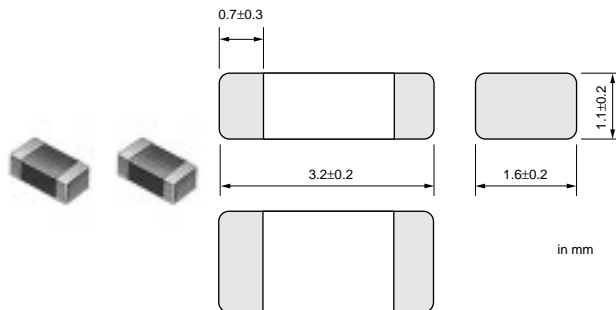

Part Number	Impedance (at 100MHz/20°C) (ohm)	Rated Current (mA)	DC Resistance (max.) (ohm)	Operating Temperature Range (°C)
BLM31PG330SH1	33 ±25%	6000	0.01	-55 to +125
BLM31PG500SH1	50 (Typ.)	3000	0.025	-55 to +125
BLM31PG121SH1	120 ±25%	3000	0.025	-55 to +125
BLM31PG391SH1	390 ±25%	2000	0.05	-55 to +125
BLM31PG601SH1	600 ±25%	1500	0.09	-55 to +125

For the items of rated current higher than 1500mA, derating is required. Please refer to p.32, "Derating of Rated Current".

■ Equivalent Circuit

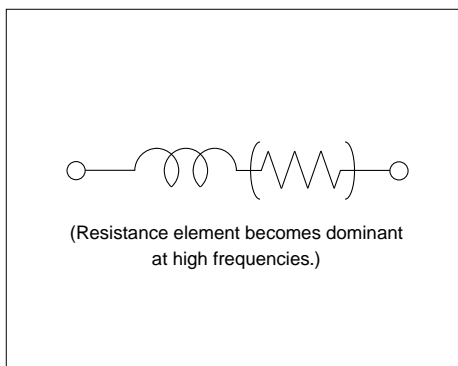

■ Impedance - Frequency (Typical)

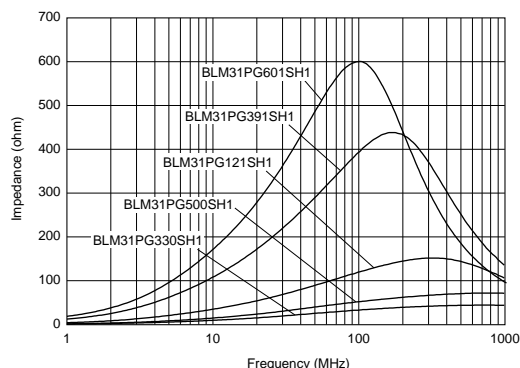

■ Impedance - Frequency Characteristics

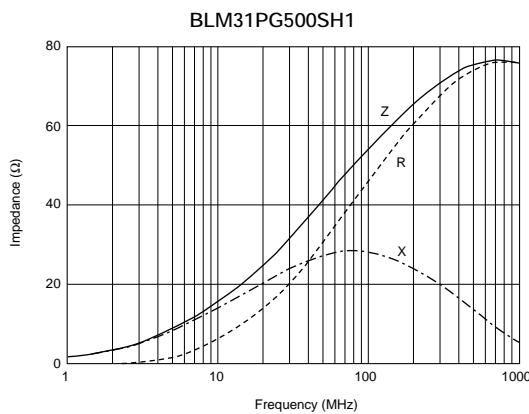
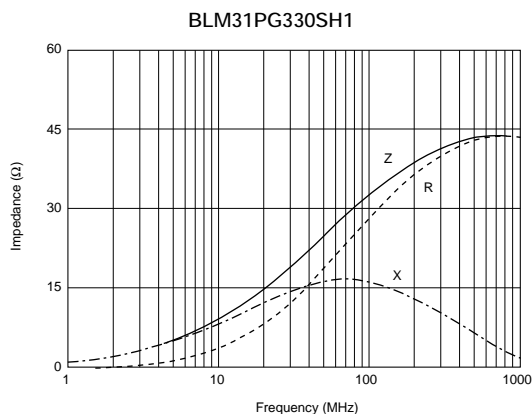

Continued on the following page. ↗

Continued from the preceding page.

Impedance - Frequency Characteristics

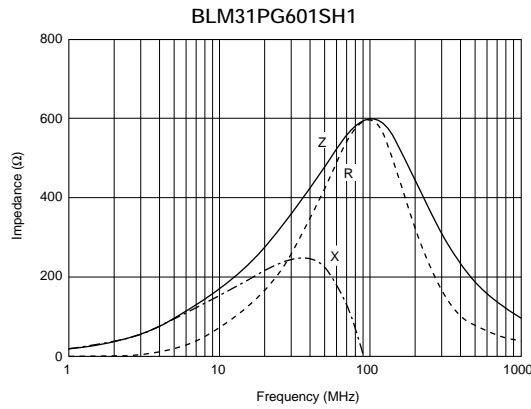
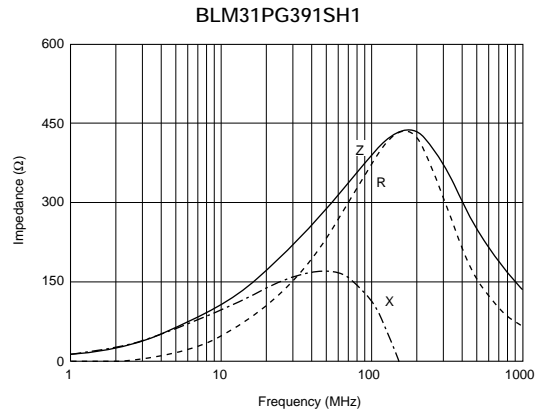
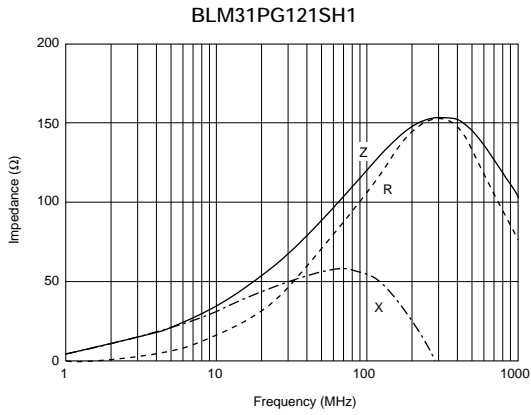

BLM41P Series

Features

The chip ferrite beads BLM series is designed to function nearly as a resistor at noise frequencies, which greatly reduces the possibility of resonance and leaves signal wave forms undistorted.

BLM series is effective in circuits without stable ground lines because BLM series does not need a connection to ground.

The nickel barrier structure of the external electrodes provides excellent solder heat resistance.

BLM_P series can be used in high current circuits due to its low DC resistance.

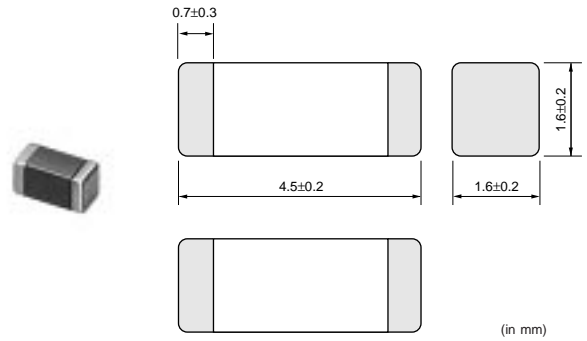

Part Number	Impedance (at 100MHz/20°C) (ohm)	Rated Current (mA)	DC Resistance (max.) (ohm)	Operating Temperature Range (°C)
BLM41PG600SH1	60 (Typ.)	6000	0.01	-55 to +125
BLM41PG750SH1	75 (Typ.)	3000	0.025	-55 to +125
BLM41PG181SH1	180 ±25%	3000	0.025	-55 to +125
BLM41PG471SH1	470 ±25%	2000	0.05	-55 to +125
BLM41PG102SH1	1000 ±25%	1500	0.09	-55 to +125

For the items of rated current higher than 1500mA, derating is required. Please refer to p.32, "Derating of Rated Current".

■ Equivalent Circuit

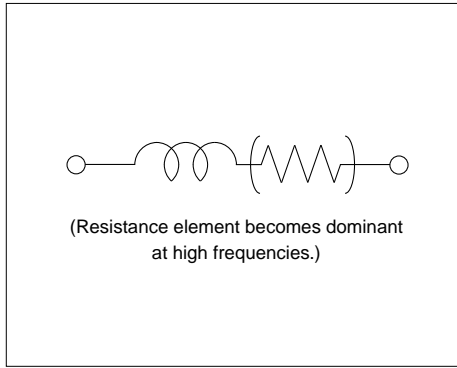

■ Impedance - Frequency (Typical)

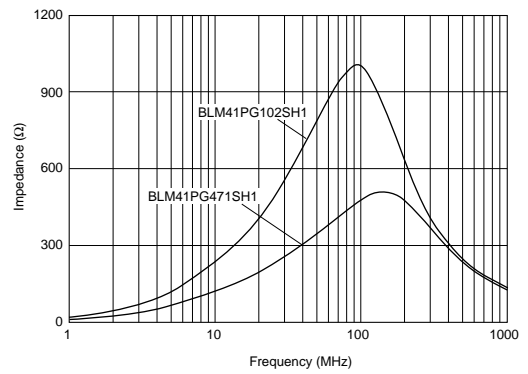
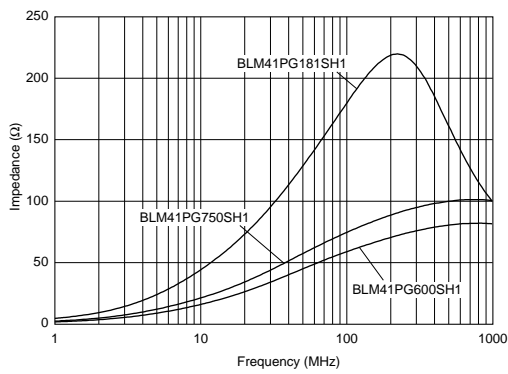

■ Impedance - Frequency Characteristics

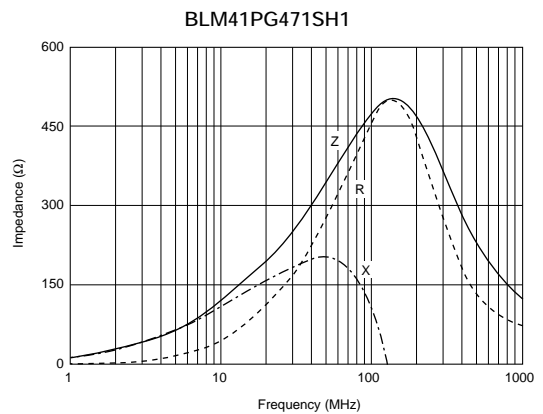
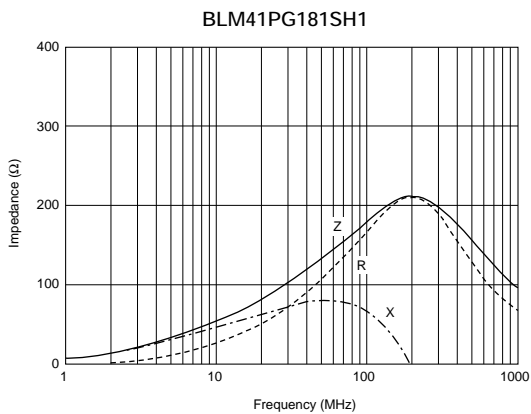
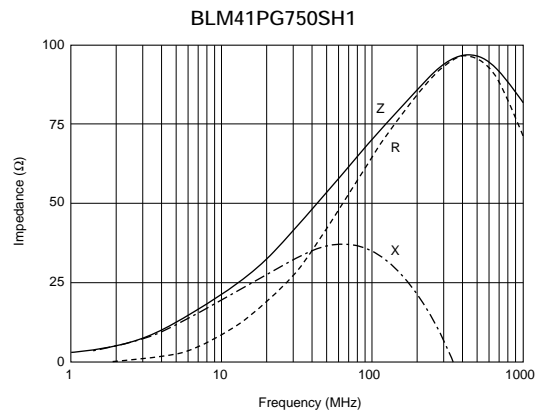
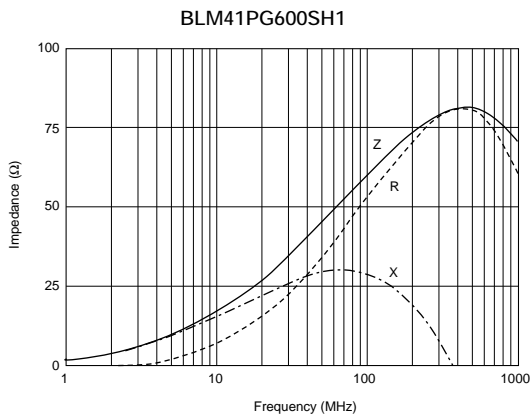

Continued on the following page.

Continued from the preceding page.

1

■ Impedance - Frequency Characteristics

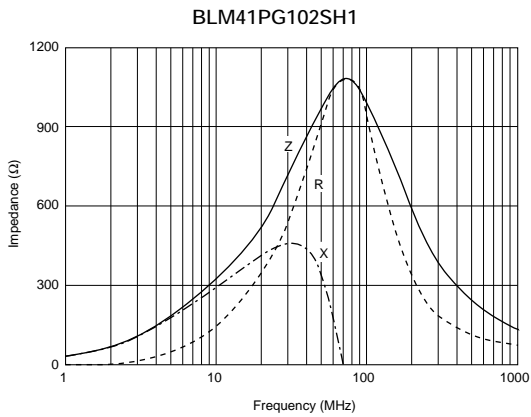

■ Notice (Rating)

In operating temperatures exceeding +85°C, derating of current is necessary for chip Ferrite Beads for which rated current is 1200mA or over. Please apply the derating curve shown in chart according to the operating temperature.

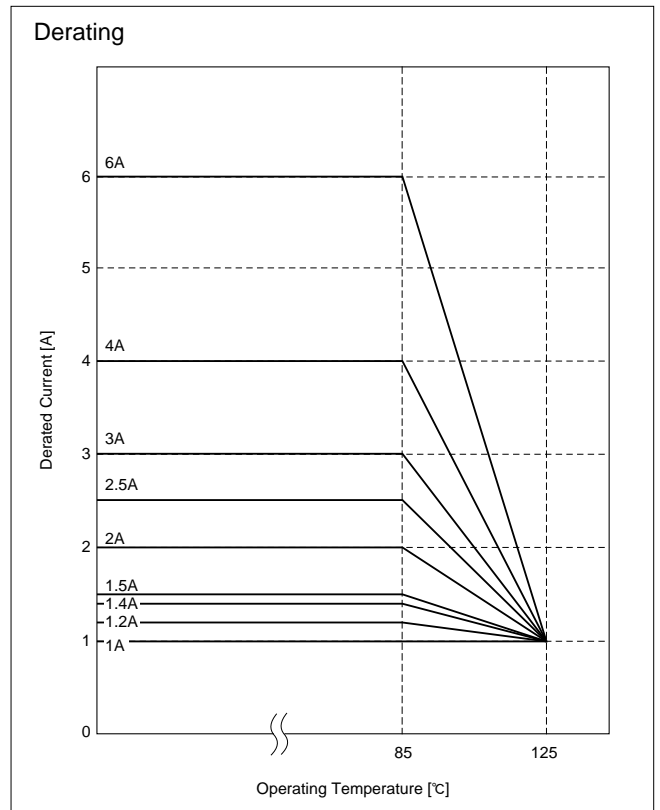

BLM18H Series

BLM18H series has a modified internal electrode structure, that minimizes stray capacitance and increases the effective frequency range.

■ Features

1. BLM18H series realizes high impedance at 1GHz and is suitable for noise suppression from 500MHz to GHz range. The impedance value of HG/HD-type is about three times as large as that of A/B-type at 1GHz though the impedance characteristic of HG/HD-type is similar to A/B-type at 100MHz or less.
2. HG-type is effective in noise suppression in wide frequency range (several MHz to several GHz). HD-type for high-speed signal line provides a sharper roll-off after the cut off frequency.
3. The magnetic shielded structure minimizes cross talk.

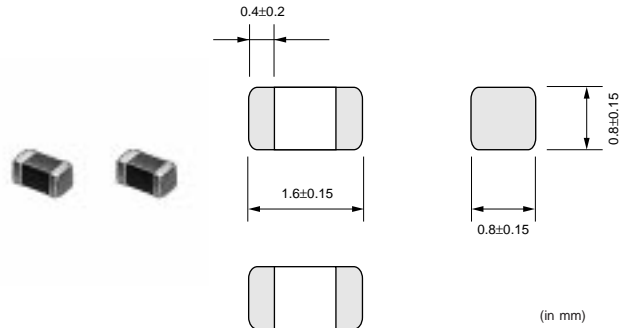

Part Number	Impedance (at 100MHz/20°C) (ohm)	Impedance (at 1GHz/20°C) (ohm)	Rated Current (mA)	DC Resistance (max.) (ohm)	Operating Temperature Range (°C)
BLM18HG471SH1	470 ±25%	600 (Typ.)	200	0.85	-55 to +125
BLM18HG601SH1	600 ±25%	700 (Typ.)	200	1.00	-55 to +125
BLM18HG102SH1	1000 ±25%	1000 (Typ.)	100	1.60	-55 to +125
BLM18HD471SH1	470 ±25%	1000 (Typ.)	100	1.20	-55 to +125
BLM18HD601SH1	600 ±25%	1200 (Typ.)	100	1.50	-55 to +125
BLM18HD102SH1	1000 ±25%	1700 (Typ.)	50	1.80	-55 to +125

■ Equivalent Circuit

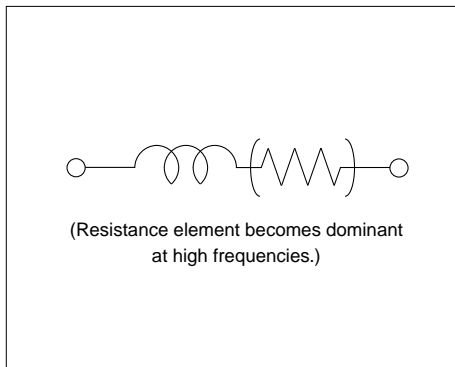

■ Impedance - Frequency (Typical)

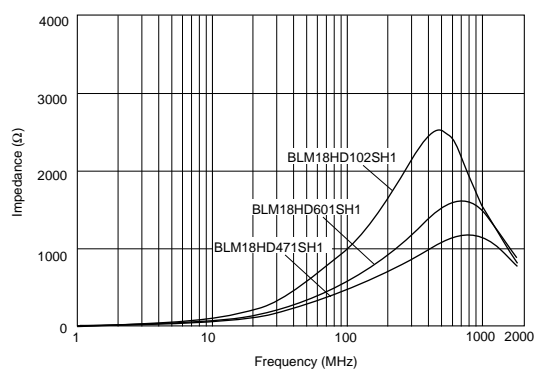
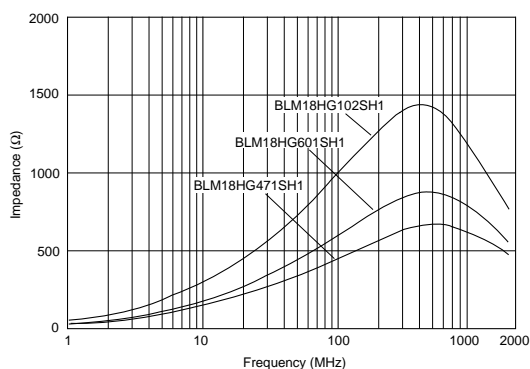

1

■ Impedance - Frequency Characteristics

BLM18HG471SH1

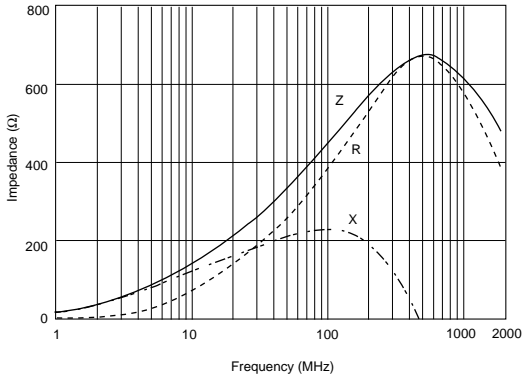

BLM18HG601SH1

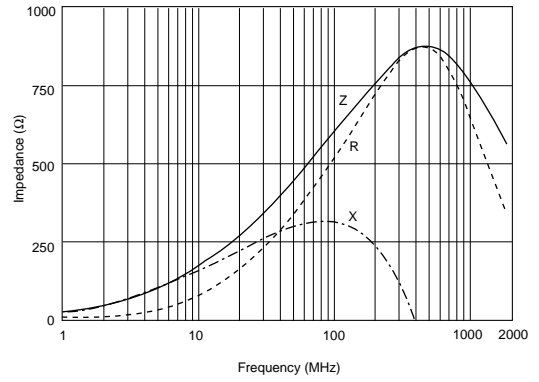

BLM18HG102SH1

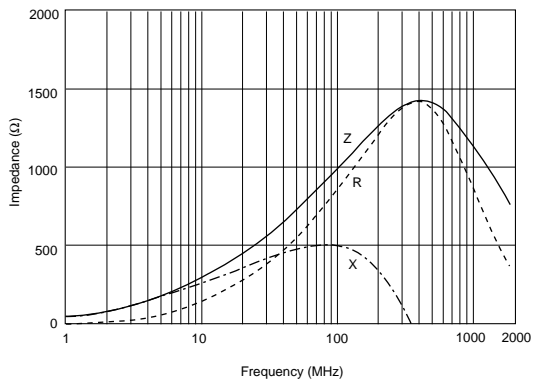

BLM18HD471SH1

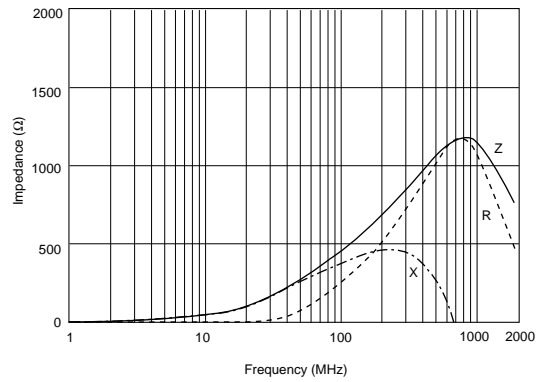

BLM18HD601SH1

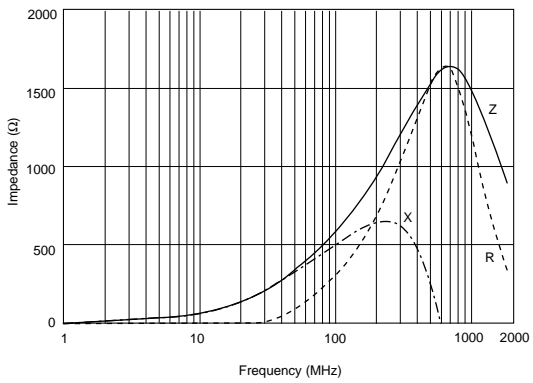

BLM18HD102SH1

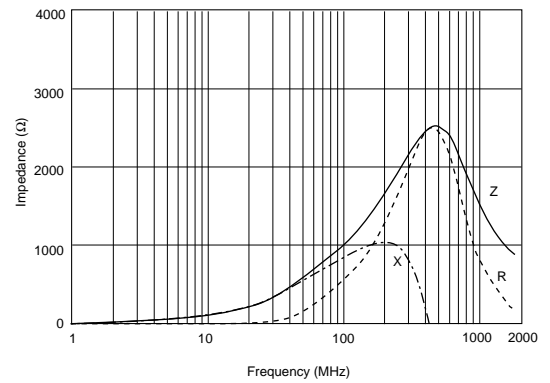

BLM18E Series

BLM18E series has a modified internal electrode structure, that minimizes stray capacitance and increases the effective frequency range.

■ Features

1. Low DC Resistance and a large Rated Current are suitable for noise suppression of the driver circuit.
2. Excellent direct current characteristics.
3. Thin type (t=0.5mm) is suitable for small and low profile equipment such as ETC, RKE.

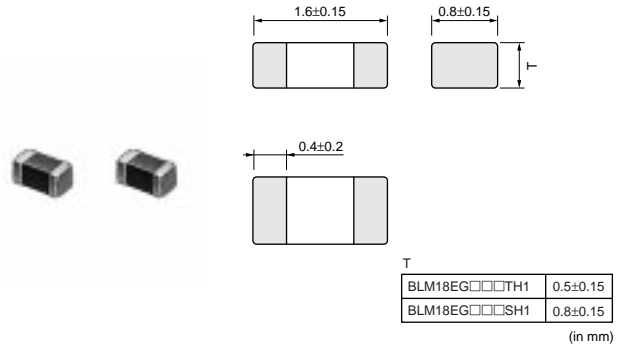

Part Number	Impedance (at 100MHz/20°C) (ohm)	Impedance (at 1GHz/20°C) (ohm)	Rated Current (mA)	DC Resistance (max.) (ohm)	Operating Temperature Range (°C)
BLM18EG101TH1	100 ±25%	140 (Typ.)	2000	0.045	-55 to +125
BLM18EG121SH1	120 ±25%	145 (Typ.)	2000	0.04	-55 to +125
BLM18EG181SH1	180 ±25%	260 (Typ.)	2000	0.05	-55 to +125
BLM18EG221TH1	220 ±25%	300 (Typ.)	1000	0.15	-55 to +125
BLM18EG331TH1	330 ±25%	450 (Typ.)	500	0.21	-55 to +125
BLM18EG391TH1	390 ±25%	520 (Typ.)	500	0.30	-55 to +125
BLM18EG471SH1	470 ±25%	550 (Typ.)	500	0.21	-55 to +125
BLM18EG601SH1	600 ±25%	700 (Typ.)	500	0.35	-55 to +125

For the items of rated current higher than 2000mA, derating is required.
 Please refer to p.37, "Derating of Rated Current".

■ Equivalent Circuit

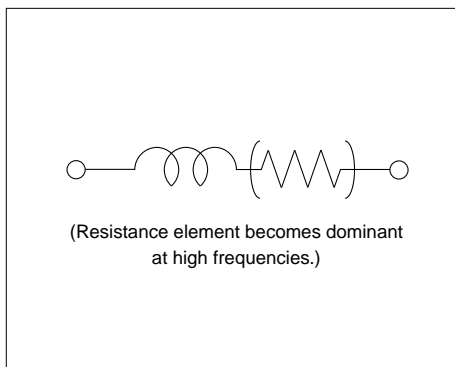

■ Impedance - Frequency (Typical)

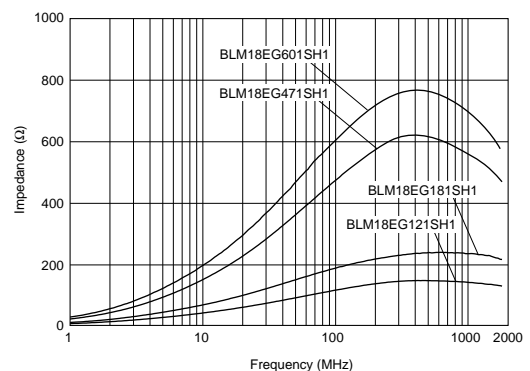
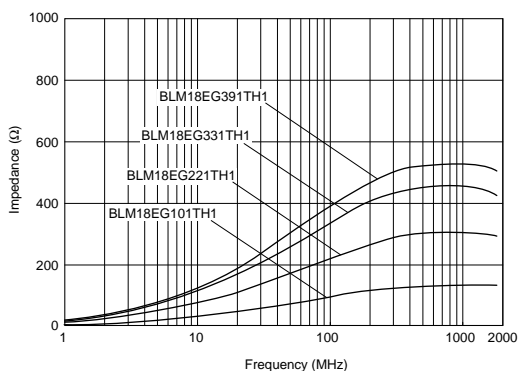

Continued on the following page. ↗

Continued from the preceding page.

Impedance - Frequency Characteristics

BLM18EG101TH1

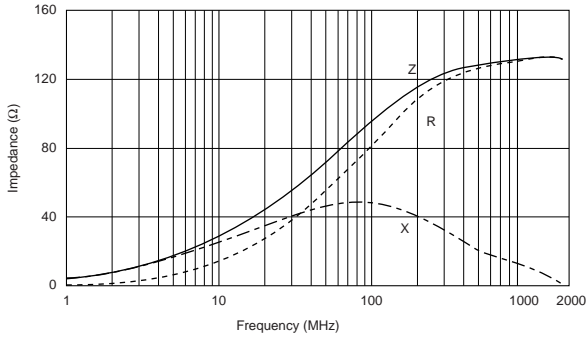

BLM18EG121SH1

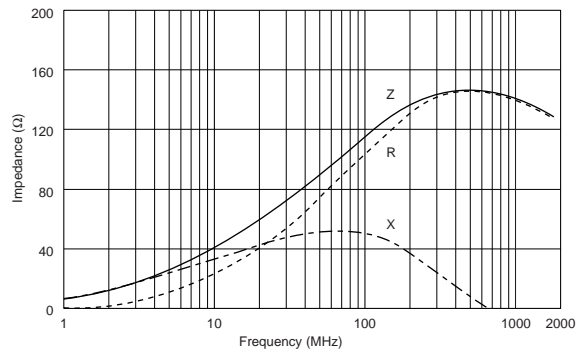

BLM18EG181SH1

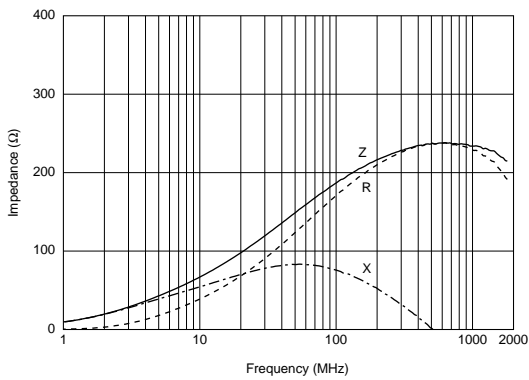

BLM18EG221TH1

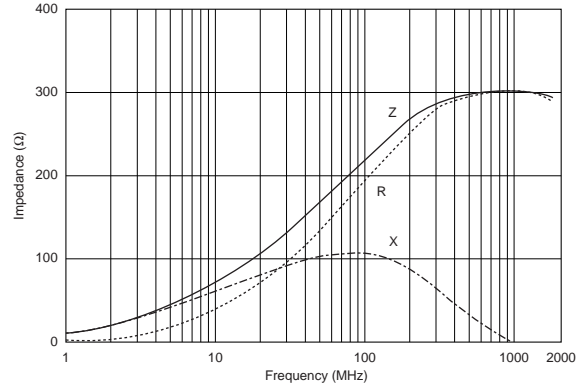

BLM18EG331TH1

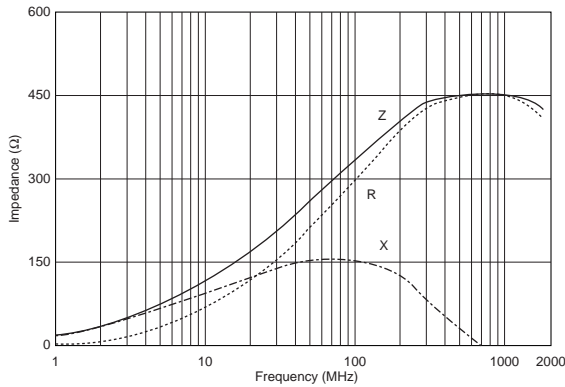

BLM18EG391TH1

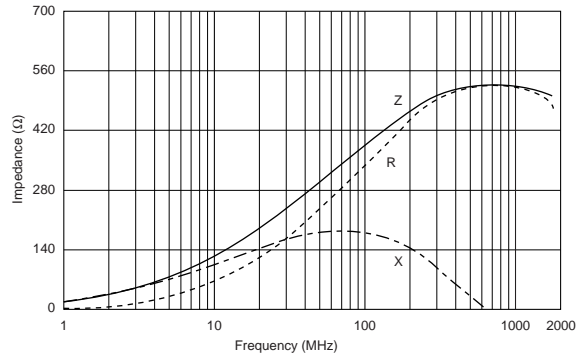

BLM18EG471SH1

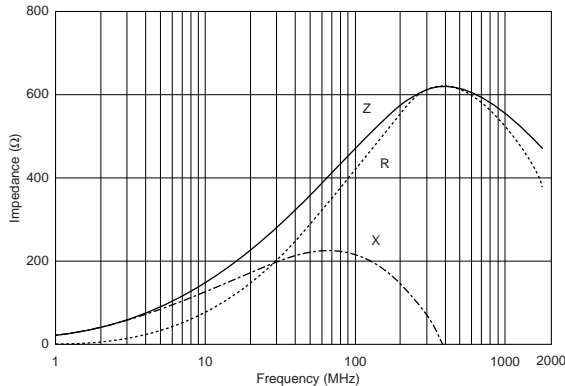

BLM18EG601SH1

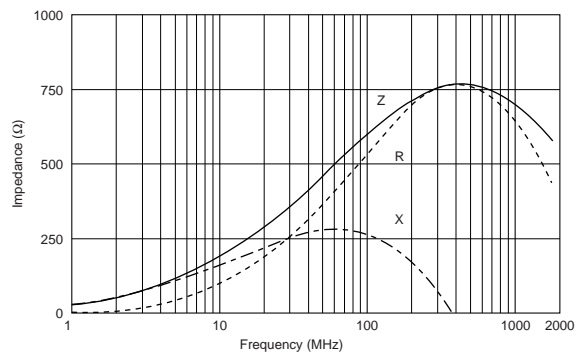

Continued on the following page. ↗

☐ Continued from the preceding page.

■ Notice (Rating)

In operating temperatures exceeding +85°C, derating of current is necessary for chip Ferrite Beads for which rated current is 1200mA or over. Please apply the derating curve shown in chart according to the operating temperature.

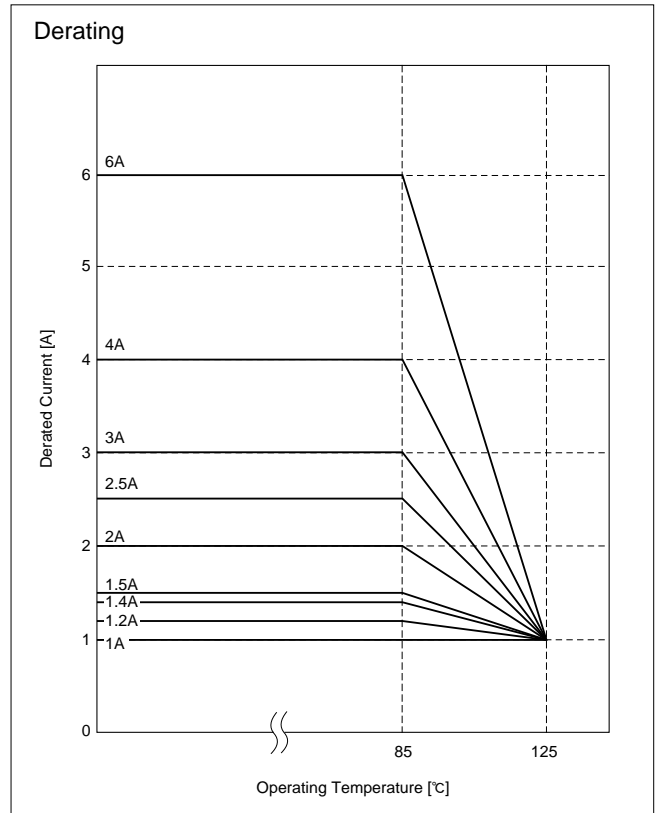

1 Specifications and Test Methods

■ Test and Measurement Conditions

<Unless otherwise specified>

Temperature: Ordinary Temp. 15 to 35°C
 Humidity: Ordinary Humidity 25 to 85% (RH)

<In case of doubt>

Temperature: 20±2°C
 Humidity: 60 to 70% (RH)
 Atmospheric Pressure: 86 to 106kPa

■ Specifications

1. Electrical Performance

No.	Item	Specifications	Test Methods						
1	Impedance	Within the specified tolerance. Impedance Frequency Characteristics (Typical): See the appendix.	Measuring Frequency <table border="1"> <tr> <td>BLM15/18/21/31/41 series</td> <td>100±1MHz</td> </tr> <tr> <td>BLM18HG/HD type</td> <td>100±1MHz, 1GHz±1MHz</td> </tr> </table> Measuring Equipment: Agilent 4291A or the equivalent Test Fixture <table border="1"> <tr> <td>BLM15/18/21/31/41 series</td> <td>Agilent 16192A or the equivalent</td> </tr> </table>	BLM15/18/21/31/41 series	100±1MHz	BLM18HG/HD type	100±1MHz, 1GHz±1MHz	BLM15/18/21/31/41 series	Agilent 16192A or the equivalent
BLM15/18/21/31/41 series	100±1MHz								
BLM18HG/HD type	100±1MHz, 1GHz±1MHz								
BLM15/18/21/31/41 series	Agilent 16192A or the equivalent								
2	DC Resistance	Meet specifications.	Measuring Equipment: Digital multi-meter						

2. Mechanical Performance

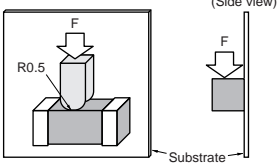
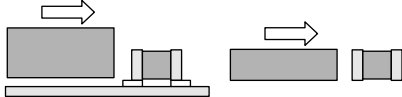
No.	Item	Specifications	Test Methods
1	Appearance and Dimensions	Meet dimensions.	Visual Inspection and measured with micrometer.
2	Solderability*1	The electrodes should be at least 95% covered with new solder coating.	Flux: Ethanol solution of rosin, 25wt% Pre-heating: 150±10°C, 60 to 90s Solder: ①Sn/Pb=60/40 ②Sn-3.0Ag-0.5Cu solder Solder Temperature: ①230±5°C ②240±5°C Immersion Time: ①4±1s ②3±1s (BLM15/18 series) ③4±1s (BLM21/31/41 series) Immersion and emersion rates: 25mm/s
3	Resistance to Soldering Heat*1		Flux: Ethanol solution of rosin, 25wt% Pre-heating: 150±10°C, 60 to 90s Solder: Sn/Pb=60/40 or Sn-3.0Ag-0.5Cu solder Solder Temperature: 270±5°C Immersion Time: 10±0.5s Immersion and emersion rates: 25mm/s Then measured after exposure to room conditions for 48±4 hrs.
4	Bonding Strength I *1	Meet Table 1, two pages ahead.	It should be soldered on the substrate. Applying Force (F): 4.9N (BLM15 series) 6.8N (BLM18 series) 9.8N (BLM21/31/41 series) Applying Time: 5±1s 
5	Bonding Strength II *2		It should be mounting with conductive glue on the substrate. Applying Force (F): 8N Applying Time: 5±1s Applying Direction as shown below. 

*1 Except BLM18AG□□□WH1

*2 BLM18AG□□□WH1 only.

Continued on the following page. ↗

Specifications and Test Methods

Continued from the preceding page.

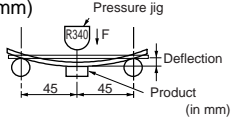
No.	Item	Specifications	Test Methods
6	Bending Strength*1		It should be soldered on the glass-epoxy substrate. Substrate: 100 × 40 × 1.6mm (BLM15 series: 100 × 40 × 0.8mm) (BLM18H series: 100 × 40 × 1.0mm) Deflection (n): 1.0mm (BLM15 series: 2.0mm) (BLM18H series: 2.0mm) Speed of Applying Force: 0.5mm/s Keeping Time: 30s 
7	Vibration I *1	Meet Table 1, next page.	It should be soldered on the substrate. Oscillation Frequency: 10 to 2000 to 10Hz for 20 min. Total Amplitude: 1.5mm or Acceleration amplitude 49m/s ² whichever is smaller. Testing Time: A period of 2 hours in each of 3 mutually perpendicular directions. (Total 6 hrs.)
8	Vibration II *2		It should be mounted with conductive glue on the substrate. Oscillation Frequency: 10 to 2000 to 10Hz for 20 min. Total Amplitude: 1.5mm or Acceleration amplitude 49m/s ² whichever is smaller. Testing Time: A period of 2 hours in each of 3 mutually perpendicular directions. (Total 6 hrs.)

*1 Except BLM18AG□□□WH1

*2 BLM18AG□□□WH1 only.

3. Environmental Performance (It should be soldered on the substrate.)

No.	Item	Specifications	Test Methods
1	Humidity	Meet Table 1, next page.	Temperature: 70±2°C Humidity: 90 to 95% (RH) Time: 1000 hrs. (±4 ₀ hrs.) Then measured after exposure to room conditions for 48±4 hrs.
2	Heat Life		Temperature: 150±3°C (BLM18AG□□□WH1 only) 125±3°C (BLM15/18/21/31 series)*1 85±3°C (BLM18PG330/121/181/221/331 type BLM21PG/31PG/41PG series) Applying Current: Rated Current Time: 1000 hrs. (±4 ₀ hrs.) Then measured after exposure to room conditions for 48±4 hrs.
3	Cold Resistance		Temperature: -55±2°C Time: 1000 hrs. (±4 ₀ hrs.) Then measured after exposure to room conditions for 48±4 hrs.
4	Temperature Cycle		1 Cycle 1 step: -55±3°C/30±3 min. 2 step: Room Temperature/within 5 min. 3 step: +125±3°C/30±3 min. 4 step: Room Temperature/within 5 min. Total of 1000 cycles Then measured after exposure to room conditions for 48±4 hrs.

*1 Except BLM18AG□□□WH1

Continued on the following page. ↗

Specifications and Test Methods

Continued from the preceding page.

4. Other Performance

No.	Item	Specifications	Test Methods																	
1	ESD Test I *1	Meet Table 1, below.	<p>The products are adhered on the substrate with the conductive glue and tested under the condition in Table, and then measured after exposure in room condition for 1 or 2 hours. Please refer to the figure about the equivalent circuit.</p> <table border="1"> <tr> <td>Capacitance for Charging and Discharging</td> <td>150pF</td> </tr> <tr> <td>Resistance for Discharging R1</td> <td>330Ω</td> </tr> <tr> <td>Resistance for Charge R2</td> <td>50 to 100MΩ</td> </tr> <tr> <td>Applying Method</td> <td>+20 times/-20 times</td> </tr> </table>	Capacitance for Charging and Discharging	150pF	Resistance for Discharging R1	330Ω	Resistance for Charge R2	50 to 100MΩ	Applying Method	+20 times/-20 times									
Capacitance for Charging and Discharging	150pF																			
Resistance for Discharging R1	330Ω																			
Resistance for Charge R2	50 to 100MΩ																			
Applying Method	+20 times/-20 times																			
2	ESD Test II *1	<p>The products are adhered on the substrate with the conductive glue and tested under the condition of Table, and then measured after exposure in room condition for 1 or 2 hours.</p> <table border="1"> <thead> <tr> <th></th> <th>Machine Model (MM)</th> <th>Human Body Model (HBM)</th> </tr> </thead> <tbody> <tr> <td>Capacitance for Charging and Discharging</td> <td>200pF</td> <td>100pF</td> </tr> <tr> <td>Resistance for Discharging R1</td> <td>0Ω</td> <td>1500Ω</td> </tr> <tr> <td>Resistance for Charge R2</td> <td>1MΩ</td> <td>1MΩ</td> </tr> <tr> <td>Applying Method</td> <td>±10 times</td> <td>±5 times</td> </tr> <tr> <td>Applying Voltage</td> <td>300V</td> <td>2kV</td> </tr> </tbody> </table>		Machine Model (MM)	Human Body Model (HBM)	Capacitance for Charging and Discharging	200pF	100pF	Resistance for Discharging R1	0Ω	1500Ω	Resistance for Charge R2	1MΩ	1MΩ	Applying Method	±10 times	±5 times	Applying Voltage	300V	2kV
	Machine Model (MM)	Human Body Model (HBM)																		
Capacitance for Charging and Discharging	200pF	100pF																		
Resistance for Discharging R1	0Ω	1500Ω																		
Resistance for Charge R2	1MΩ	1MΩ																		
Applying Method	±10 times	±5 times																		
Applying Voltage	300V	2kV																		

*1 BLM18AG□□□WH1 only.

Table 1.

Appearance	No damage
Impedance Change (at 100MHz)	within ±30%
DC Resistance	Meet Table 2, next page.

Continued on the following page. ↗

Specifications and Test Methods

Continued from the preceding page.

Table 2.

Part Number	DC Resistance (ohm max.) Values After Testing	Part Number	DC Resistance (ohm max.) Values After Testing	Part Number	DC Resistance (ohm max.) Values After Testing	Part Number	DC Resistance (ohm max.) Values After Testing
BLM15AG100SH1	0.10	BLM18BA470SH1	0.65	BLM18HG601SH1	1.10	BLM21BD421SH1	0.40
BLM15AG700SH1	0.20	BLM18BB470SH1	0.35	BLM18HG102SH1	1.70	BLM21BB471SH1	0.55
BLM15AG121SH1	0.35	BLM18BD470SH1	0.40	BLM18HD471SH1	1.30	BLM21BD471SH1	0.45
BLM15AG221SH1	0.45	BLM18BB600SH1	0.35	BLM18HD601SH1	1.60	BLM21BD601SH1	0.45
BLM15AG601SH1	0.70	BLM18BA750SH1	0.80	BLM18HD102SH1	1.90	BLM21BD751SH1	0.50
BLM15AG102SH1	1.10	BLM18BB750SH1	0.40	BLM18EG101TH1	0.07	BLM21BD102SH1	0.50
BLM15BB050SH1	0.15	BLM18BA121SH1	1.00	BLM18EG121SH1	0.06	BLM21BD152SH1	0.55
BLM15BB100SH1	0.15	BLM18BB121SH1	0.40	BLM18EG181SH1	0.08	BLM21BD182SH1	0.60
BLM15BB220SH1	0.30	BLM18BD121SH1	0.50	BLM18EG221TH1	0.21	BLM21BD222SH1	0.70
BLM15BB470SH1	0.45	BLM18BB141SH1	0.45	BLM18EG331TH1	0.30	BLM21BD222TH1	0.70
BLM15BB750SH1	0.50	BLM18BB151SH1	0.47	BLM18EG391TH1	0.40	BLM21BD272SH1	0.90
BLM15BB121SH1	0.65	BLM18BD151SH1	0.50	BLM18EG471SH1	0.30	BLM21PG220SH1	0.02
BLM15BB221SH1	0.90	BLM18BB221SH1	0.55	BLM18EG601SH1	0.45	BLM21PG300SH1	0.03
BLM15BD471SH1	0.70	BLM18BD221SH1	0.55			BLM21PG600SH1	0.05
BLM15BD601SH1	0.75	BLM18BB331SH1	0.68			BLM21PG221SH1	0.10
BLM15BD102SH1	1.00	BLM18BD331SH1	0.60	BLM21AG121SH1	0.25	BLM21PG331SH1	0.18
BLM15BD182SH1	1.50	BLM18BD421SH1	0.65	BLM21AG151SH1	0.25		
		BLM18BB471SH1	0.95	BLM21AG221SH1	0.30		
		BLM18BD471SH1	0.65	BLM21AG331SH1	0.35	BLM31AJ601SH1	0.10
BLM18AG121SH1	0.28	BLM18BD601SH1	0.75	BLM21AG471SH1	0.35	BLM31PG330SH1	0.02
BLM18AG151SH1	0.35	BLM18BD102SH1	0.95	BLM21AG601SH1	0.40	BLM31PG500SH1	0.05
BLM18AG221SH1	0.35	BLM18BD152SH1	1.30	BLM21AG102SH1	0.55	BLM31PG121SH1	0.05
BLM18AG331SH1	0.40	BLM18BD182SH1	1.60	BLM21BB050SH1	0.14	BLM31PG391SH1	0.10
BLM18AG471SH1	0.45	BLM18BD222SH1	1.60	BLM21BB600SH1	0.25	BLM31PG601SH1	0.18
BLM18AG601SH1	0.48	BLM18BD252SH1	1.60	BLM21BB750SH1	0.35		
BLM18AG102SH1	0.60	BLM18PG300SH1	0.10	BLM21BB121SH1	0.35		
BLM18AG471WH1	0.26	BLM18PG330SH1	0.05	BLM21BD121SH1	0.35	BLM41PG600SH1	0.02
BLM18AG102WH1	0.80	BLM18PG600SH1	0.20	BLM21BB151SH1	0.35	BLM41PG750SH1	0.05
BLM18BA050SH1	0.30	BLM18PG121SH1	0.10	BLM21BD151SH1	0.35	BLM41PG181SH1	0.05
BLM18BB050SH1	0.10	BLM18PG181SH1	0.18	BLM21BB201SH1	0.45	BLM41PG471SH1	0.10
BLM18BA100SH1	0.35	BLM18PG221SH1	0.14	BLM21BB221SH1	0.45	BLM41PG102SH1	0.18
BLM18BB100SH1	0.15	BLM18PG331SH1	0.195	BLM21BD221SH1	0.35		
BLM18BA220SH1	0.45	BLM18PG471SH1	0.26	BLM21BB331SH1	0.50		
BLM18BB220SH1	0.30	BLM18HG471SH1	0.95	BLM21BD331SH1	0.40		

On-Board Type (DC) EMI Suppression Filters (EMIFIL[®]) for Automotive



Chip EMIFIL[®] Part Numbering

Chip EMIFIL[®] Capacitor Type for Automotive

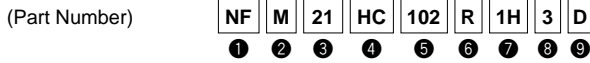

① Product ID

Product ID	
NF	Chip EMI Filters Capacitor Type

② Structure

Code	Structure
M	Capacitor Type
E	Block, LC Combined Type

③ Dimensions (L×W)

Code	Dimensions (L×W)	EIA
21	2.0×1.25mm	0805
61	6.8×1.6mm	2606

④ Features

Code	Features
HC	For Automotive
HT	T Circuit for Heavy-duty

⑤ Capacitance

Expressed by three figures. The unit is in pico-farad (pF). The first and second figures are significant digits, and the third figure expresses the number of zeros which follow the two figures.

⑥ Characteristics

Code	Capacitance Change (Temperature Characteristics)
C	±20%, ±22%
D	+20/-30%, +22/-33%
F	+30/-80%, +22/-82%
R	±15%
U	-750 ±120ppm/°C
Z	Other

⑦ Rated Voltage

Code	Rated Voltage
1A	10V
1H	50V
2A	100V

⑧ Electrode/Others

Code	Electrode
3	Sn Plating
9	Others

⑨ Packaging

Code	Packaging	Series
L	Embossed Taping (ø180mm Reel)	NFE
K	Embossed Taping (ø330mm Reel)	
B	Bulk	All series
D	Paper Taping (ø180mm Reel)	NFM

On-Board Type (DC) EMI Suppression Filters (EMIFIL[®]) for Automotive



Chip EMIFIL[®] Capacitor Type NFM21H Series

The chip "EMIFIL" NFM21H series is a chip type three terminal EMI suppression filter. It can reduce residual inductance to an extremely low level making it excellent for noise suppression at high frequencies.

■ Features

1. Wide operating temperature range (-55 to +125 degrees C)
2. Three terminal structure enables high performance in high frequency range.
3. Uses original electrode structure which realizes excellent solderability.
4. An electrostatic capacitance range of 22 to 470,000pF enables suppression of noise at specific frequencies.

■ Applications

Severe EMI suppression and high impedance circuits such as digital circuits.

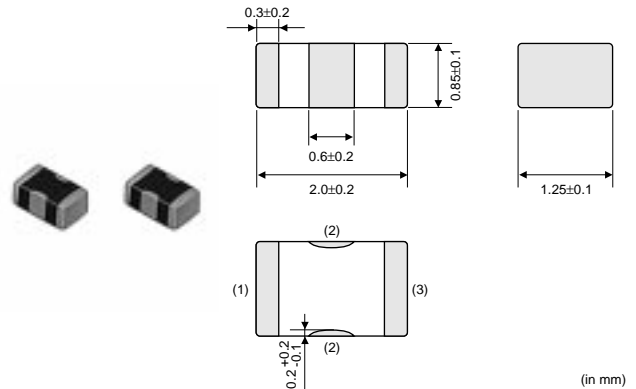

Part Number	Capacitance (pF)	Rated Voltage (Vdc)	Rated Current (mA)	Insulation Resistance (min.) (M ohm)	Operating Temperature Range (°C)
NFM21HC220U1H3	22 +20%, -20%	50	700	1000	-55 to +125
NFM21HC470U1H3	47 +20%, -20%	50	700	1000	-55 to +125
NFM21HC101U1H3	100 +20%, -20%	50	700	1000	-55 to +125
NFM21HC221R1H3	220 +20%, -20%	50	700	1000	-55 to +125
NFM21HC471R1H3	470 +20%, -20%	50	1000	1000	-55 to +125
NFM21HC102R1H3	1000 +20%, -20%	50	1000	1000	-55 to +125
NFM21HC222R1H3	2200 +20%, -20%	50	1000	1000	-55 to +125
NFM21HC223R1H3	22000 +20%, -20%	50	2000	1000	-55 to +125
NFM21HC104R1A3	100000 +20%, -20%	10	2000	1000	-55 to +125
NFM21HC224R1A3	220000 +20%, -20%	10	2000	1000	-55 to +125
NFM21HC474R1A3	470000 +20%, -20%	10	2000	1000	-55 to +125

■ Equivalent Circuit

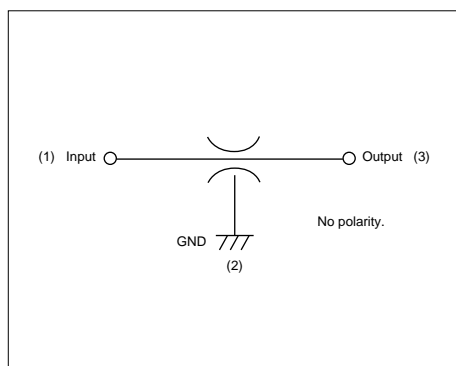

■ Insertion Loss Characteristics

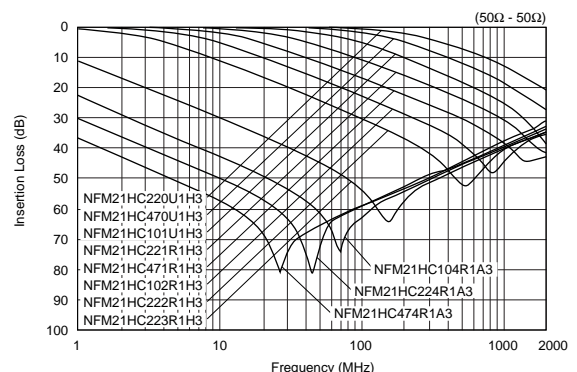

Specifications and Test Methods

■ Test and Measurement Conditions

<Unless otherwise specified>

Temperature: Ordinary Temp. 15 to 35°C
 Humidity: Ordinary Humidity 25 to 85% (RH)

<In case of doubt>

Temperature: 20±2°C
 Humidity: 60 to 70% (RH)
 Atmospheric Pressure: 86 to 106kPa

■ Specifications

1. Electrical Performance

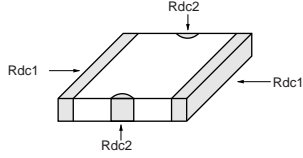
No.	Item	Specifications	Test Methods				
1	Capacitance (Cap.)	Within the specified tolerance.	Frequency <table border="1"> <tr> <td>22 to 100pF</td> <td>1.0±0.1MHz</td> </tr> <tr> <td>220 to 470000pF</td> <td>1.0±0.1kHz</td> </tr> </table> Voltage: 1±0.2Vrms	22 to 100pF	1.0±0.1MHz	220 to 470000pF	1.0±0.1kHz
22 to 100pF	1.0±0.1MHz						
220 to 470000pF	1.0±0.1kHz						
2	Insulation Resistance (I.R.)	1000MΩ min.	Voltage: Rated Voltage Charging Time: 2 minutes max.				
3	Withstanding Voltage	Products should not be damaged.	Test Voltage <table border="1"> <tr> <td>22 to 22000pF</td> <td>150Vdc</td> </tr> <tr> <td>100000 to 470000pF</td> <td>30Vdc</td> </tr> </table> Testing Time: 1 to 5s Charge/Discharge Current: 50mA max.	22 to 22000pF	150Vdc	100000 to 470000pF	30Vdc
22 to 22000pF	150Vdc						
100000 to 470000pF	30Vdc						
4	DC Resistance (Rdc1, 2)	22 to 2200pF: 0.3Ω max. 22000 to 470000pF: 0.03Ω max.	Measured with 100mA max. Rdc1: between signal terminals Rdc2: between ground terminals 				

2. Mechanical Performance

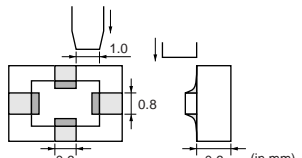
No.	Item	Specifications	Test Methods														
1	Appearance and Dimensions	Meet dimensions.	Visual Inspection and measured with micrometer.														
2	Solderability	Electrodes should be at least 90% covered with new solder coating.	Flux: Ethanol solution of rosin, 25wt% Pre-heating: 150±10°C, 60 to 90s Solder: ①Sn/Pb=60/40 ②Sn-3.0Ag-0.5Cu solder Solder Temperature: ①230± 5°C ②240± 3°C Immersion Time: ①2±0.5s ②3±1s Immersion and emersion rates: 25mm/s														
3	Resistance to Soldering Heat	Meet Table 1. Table 1 <table border="1"> <tr> <td>Appearance</td> <td colspan="2">No damage</td> </tr> <tr> <td>Cap. Change (%ΔC)</td> <td colspan="2">Within ± 7.5%</td> </tr> <tr> <td>I.R.</td> <td colspan="2">1000MΩ min.</td> </tr> <tr> <td rowspan="2">Rdc 1, 2</td> <td>22 to 2200pF</td> <td>0.5Ω max.</td> </tr> <tr> <td>22000 to 470000pF</td> <td>0.05Ω max.</td> </tr> </table>	Appearance	No damage		Cap. Change (%ΔC)	Within ± 7.5%		I.R.	1000MΩ min.		Rdc 1, 2	22 to 2200pF	0.5Ω max.	22000 to 470000pF	0.05Ω max.	Flux: Ethanol solution of rosin, 25wt% Pre-heating: 150±10°C, 60 to 90s Solder: Sn/Pb = 60/40 or Sn-30Ag-0.5Cu solder Solder Temperature: 270 ± 5°C Immersion Time: 10±1s Immersion and emersion rates: 25mm/s Initial values: About 220 to 470000pF, measured after heat treatment (150±10°C, 1 hour) and exposure in the room condition for 48±4 hrs. Then measured after exposure in room conditions for the following hours. 22 to 100pF: 24±2 hrs. 220 to 470000pF: 48±4 hrs.
Appearance	No damage																
Cap. Change (%ΔC)	Within ± 7.5%																
I.R.	1000MΩ min.																
Rdc 1, 2	22 to 2200pF	0.5Ω max.															
	22000 to 470000pF	0.05Ω max.															
4	Bonding Strength	The electrodes should show no failure after testing.	It should be soldered on the glass-epoxy substrate. Applying Force: 17.6N Applying Time: 60s 														

Continued on the following page. ↗

Specifications and Test Methods

Continued from the preceding page.

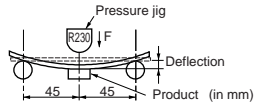
No.	Item	Specifications	Test Methods								
5	Bending Strength	Meet Table 2. Table 2	It should be soldered on the glass-epoxy substrate (t=1mm). Deflection: 2.0mm Keeping Time: 30s 								
		<table border="1"> <tr> <td>Appearance</td> <td colspan="2">No damage</td> </tr> <tr> <td>Cap. Change (%ΔC)</td> <td colspan="2">Within ± 12.5%</td> </tr> <tr> <td rowspan="2">Rdc1, 2</td> <td>22 to 2200pF</td> <td>0.5Ω max.</td> </tr> <tr> <td>22000 to 470000pF</td> <td>0.05Ω max.</td> </tr> </table>		Appearance	No damage		Cap. Change (%ΔC)	Within ± 12.5%		Rdc1, 2	22 to 2200pF
Appearance	No damage										
Cap. Change (%ΔC)	Within ± 12.5%										
Rdc1, 2	22 to 2200pF	0.5Ω max.									
	22000 to 470000pF	0.05Ω max.									
6	Vibration	Meet Table 3. Table 3	It should be soldered on the glass-epoxy substrate. Oscillation Frequency: 10 to 55 to 10Hz for 1 min. Total Amplitude: 1.5mm Testing Time: A period of 2 hrs. in each of 3 mutually perpendicular directions. (Total 6 hrs.) About 220 to 470000pF: heat treatment (150±10°C, 1 hr.)								
		<table border="1"> <tr> <td>Appearance</td> <td colspan="2">No damage</td> </tr> <tr> <td>Capacitance</td> <td colspan="2">Within the specified tolerance.</td> </tr> <tr> <td rowspan="2">Rdc1, 2</td> <td>22 to 2200pF</td> <td>0.5Ω max.</td> </tr> <tr> <td>22000 to 470000pF</td> <td>0.05Ω max.</td> </tr> </table>		Appearance	No damage		Capacitance	Within the specified tolerance.		Rdc1, 2	22 to 2200pF
Appearance	No damage										
Capacitance	Within the specified tolerance.										
Rdc1, 2	22 to 2200pF	0.5Ω max.									
	22000 to 470000pF	0.05Ω max.									

3. Environment Performance (It should be soldered on the glass-epoxy substrate.)

No.	Item	Specifications	Test Methods														
1	Humidity		Temperature: 70±2°C Humidity: 90 to 95% (RH) Time: 1000 hrs. (±48 hrs.) Then measured after exposure to room conditions for the following hours. 22 to 100pF: 24±2 hrs. 220 to 470000pF: 48±4 hrs.														
2	Biased Humidity		Temperature: 85±2°C Humidity: 80 to 85% (RH) Test Voltage: Rated Voltage Time: 1000 hrs. (±48 hrs.) Then measured after exposure to room conditions for the following hours. 22 to 100pF: 24±2 hrs. 220 to 470000pF: 48±4 hrs.														
3	High Temperature Exposure	Meet Table 4. Table 4	Temperature: 150±2°C Time: 1000 hrs. (±48 hrs.) Then measured after exposure to room conditions for the following hours. 22 to 100pF: 24±2 hrs. 220 to 470000pF: 48±4 hrs.														
4	Heat Life	<table border="1"> <tr> <td>Appearance</td> <td colspan="2">No damage</td> </tr> <tr> <td>Cap. Change (%ΔC)</td> <td colspan="2">Within ± 12.5%</td> </tr> <tr> <td>I.R.</td> <td colspan="2">1000MΩ min.</td> </tr> <tr> <td rowspan="2">Rdc1, 2</td> <td>22 to 2200pF</td> <td>0.5Ω max.</td> </tr> <tr> <td>22000 to 470000pF</td> <td>0.05Ω max.</td> </tr> </table>	Appearance	No damage		Cap. Change (%ΔC)	Within ± 12.5%		I.R.	1000MΩ min.		Rdc1, 2	22 to 2200pF	0.5Ω max.	22000 to 470000pF	0.05Ω max.	Temperature: 125±2°C Test Voltage: Rated voltage×200% Charge/Discharge Current: 50mA max. Time: 1000hrs. (±48 hrs.) Initial values: About 220 to 470000pF, measured after voltage treatment (Maximum Operating Temperature ±2°C, Rated Voltage×200%, 1 hour) and exposure in room condition for 48±4 hrs. Then measured after exposure to room conditions for the following hours. 22 to 100pF: 24±2 hrs. 220 to 470000pF: 48±4 hrs.
Appearance	No damage																
Cap. Change (%ΔC)	Within ± 12.5%																
I.R.	1000MΩ min.																
Rdc1, 2	22 to 2200pF	0.5Ω max.															
	22000 to 470000pF	0.05Ω max.															
5	Cold Resistance		Temperature: -55 ± 2°C Time: 1000 hrs. (±48 hrs.) Then measured after exposure to room conditions for the following hours. 22 to 100pF: 24±2 hrs. 220 to 470000pF: 48±4 hrs.														

Continued on the following page. 

Specifications and Test Methods

Continued from the preceding page.

No.	Item	Specifications	Test Methods														
6	Temperature Cycle	Meet Table 5. Table 5 <table border="1"> <tr> <td>Appearance</td> <td colspan="2">No damage</td> </tr> <tr> <td>Cap. Change (%ΔC)</td> <td colspan="2">Within ± 7.5%</td> </tr> <tr> <td>I.R.</td> <td colspan="2">1000MΩ min.</td> </tr> <tr> <td rowspan="2">Rdc1, 2</td> <td>22 to 2200pF</td> <td>0.5Ω max.</td> </tr> <tr> <td>22000 to 470000pF</td> <td>0.05Ω max.</td> </tr> </table>	Appearance	No damage		Cap. Change (%ΔC)	Within ± 7.5%		I.R.	1000MΩ min.		Rdc1, 2	22 to 2200pF	0.5Ω max.	22000 to 470000pF	0.05Ω max.	1 Cycle 1 step: -55± ⁹ / ₀ °C/30±3 minutes 2 step: Room Temperature/within 5 minutes 3 step: +125± ³ / ₀ °C/30 ±3 minutes 4 step: Room Temperature/within 5 minutes Total of 1000 cycles Initial values: About 220 to 470000pF, measured after heat treatment (150± ⁹ / ₀ °C, 1 hr.) and exposure in room condition for 48±4 hrs. Then measured after exposure to room conditions for the following hours. 22 to 100pF: 24±2 hrs. 220 to 470000pF: 48±4 hrs.
Appearance	No damage																
Cap. Change (%ΔC)	Within ± 7.5%																
I.R.	1000MΩ min.																
Rdc1, 2	22 to 2200pF	0.5Ω max.															
	22000 to 470000pF	0.05Ω max.															

2

On-Board Type (DC) EMI Suppression Filters (EMIFIL[®]) for Automotive



Chip EMIFIL[®] LC Combined Type for Large Current NFE61H Series

The T-type chip EMI Filter NFE61H series consists of a feedthrough capacitor and ferrite beads.

■ Features

1. Its large rated current of 2A and low voltage drop due to small DC resistance are suitable for DC power line use.
2. The feedthrough capacitor realizes excellent high frequency characteristics.
3. The structure incorporates built-in ferrite beads which minimize resonance with surrounding circuits.
4. 33 to 3,300pF lineups can be used in signal lines.

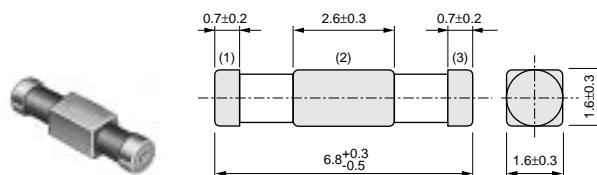

(in mm)

Part Number	Capacitance (pF)	Rated Voltage (Vdc)	Rated Current (A)	Insulation Resistance (min.) (M ohm)	Operating Temperature Range (°C)
NFE61HT330U2A9	33 +30%, -30%	100	2	1000	-55 to +125
NFE61HT680R2A9	68 +30%, -30%	100	2	1000	-55 to +125
NFE61HT101Z2A9	100 +30%, -30%	100	2	1000	-55 to +125
NFE61HT181C2A9	180 +30%, -30%	100	2	1000	-55 to +125
NFE61HT361C2A9	360 +20%, -20%	100	2	1000	-55 to +125
NFE61HT681D2A9	680 +30%, -30%	100	2	1000	-55 to +125
NFE61HT102F2A9	1000 +80%, -20%	100	2	1000	-55 to +125
NFE61HT332Z2A9	3300 +80%, -20%	100	2	1000	-55 to +125

■ Equivalent Circuit

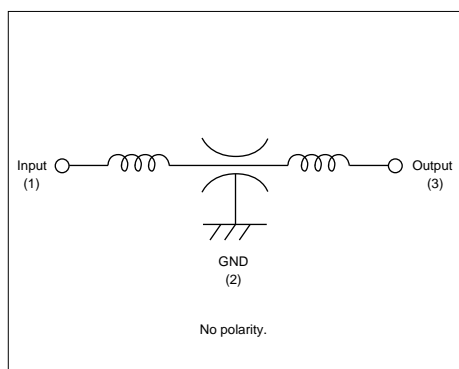

■ Insertion Loss Characteristics

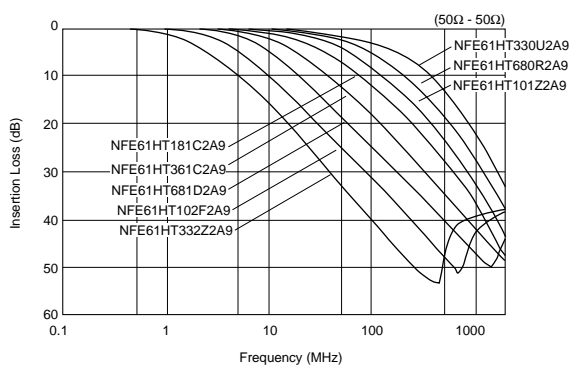

Specifications and Test Methods

■ Test and Measurement Conditions

<Unless otherwise specified>

Temperature: Ordinary Temp. 15 to 35°C
 Humidity: Ordinary Humidity 25 to 85% (RH)

<In case of doubt>

Temperature: 20±2°C
 Humidity: 60 to 70% (RH)
 Atmospheric Pressure: 86 to 106kPa

■ Specifications

1. Electrical Performance

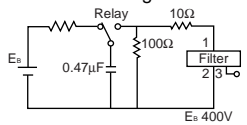
No.	Item	Specifications	Test Methods														
1	Capacitance (Cap.)	Within the specified tolerance.	Table 1 <table border="1"> <thead> <tr> <th>Capacitance</th> <th>Voltage</th> <th>Frequency</th> </tr> </thead> <tbody> <tr> <td>33, 68, 100 (pF)</td> <td>1 to 5Vrms</td> <td>1MHz±10%</td> </tr> <tr> <td>180, 360, 680, 1000, 3300 (pF)</td> <td>1±0.2Vrms</td> <td>1kHz±10%</td> </tr> </tbody> </table>	Capacitance	Voltage	Frequency	33, 68, 100 (pF)	1 to 5Vrms	1MHz±10%	180, 360, 680, 1000, 3300 (pF)	1±0.2Vrms	1kHz±10%					
Capacitance	Voltage	Frequency															
33, 68, 100 (pF)	1 to 5Vrms	1MHz±10%															
180, 360, 680, 1000, 3300 (pF)	1±0.2Vrms	1kHz±10%															
2	Insulation Resistance (I.R.)	1000MΩ min.	Voltage: 100Vdc Charging Time: 60±5s														
3	Withstanding Voltage	Products should not be damaged.	Test Voltage: 250Vdc Testing Time: 1 to 5s Charge/Discharge Current: 10mA max.														
4	Resistance to Surge Voltage	Meet Table 2. <table border="1"> <thead> <tr> <th>Appearance</th> <th colspan="2">No damage</th> </tr> </thead> <tbody> <tr> <td rowspan="2">Cap. Change</td> <td>33, 68, 100, 180, 360, 680 (pF)</td> <td>within ±15%</td> </tr> <tr> <td>1000, 3300 (pF)</td> <td>within ±30%</td> </tr> <tr> <td>I.R.</td> <td colspan="2">1000MΩ min.</td> </tr> <tr> <td>Withstanding Voltage</td> <td colspan="2">No damage</td> </tr> </tbody> </table>	Appearance	No damage		Cap. Change	33, 68, 100, 180, 360, 680 (pF)	within ±15%	1000, 3300 (pF)	within ±30%	I.R.	1000MΩ min.		Withstanding Voltage	No damage		Attenuating transient voltage of exponential function should be applied to products in the following conditions.  Peak Voltage: 400V Force Period: 1s The number of Surges: 10 ⁵
Appearance	No damage																
Cap. Change	33, 68, 100, 180, 360, 680 (pF)	within ±15%															
	1000, 3300 (pF)	within ±30%															
I.R.	1000MΩ min.																
Withstanding Voltage	No damage																

2. Mechanical Performance

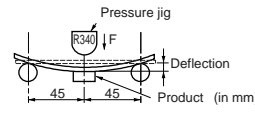
No.	Item	Specifications	Test Methods								
1	Appearance and Dimensions	Meet dimensions.	Visual Inspection and measured with micrometer.								
2	Solderability	The electrodes should be at least 75% covered with new solder coating.	Flux: Ethanol solution of rosin, 25wt% Pre-heat: 150±10°C, 60 to 90s Solder: ①Sn/Pb = 60/40 ②Sn-3.0Ag-0.5Cu solder Solder Temperature: ①230±5°C ②240±3°C Immersion Time: ①4±1s ②3±1s Immersion and emersion rates: 25mm/s								
3	Resistance to Soldering Heat	Meet Table 2, above.	Flux: Ethanol solution of rosin, 25wt% Pre-heat: 150±10°C, 60 to 90s Solder: Sn/Pb = 60/40 or Sn-3.0Ag-0.5Cu solder Solder Temperature: 270±5°C (for NFE61HT332Z2A9□: 250±5°C) Immersion Time: 10±1s Immersion and emersion rates: 25mm/s Then measured after exposure in room condition for 4 to 48 hrs.								
4	Bending Strength	Meet Table 3. <table border="1"> <thead> <tr> <th>Appearance</th> <th colspan="2">No damage</th> </tr> </thead> <tbody> <tr> <td rowspan="2">Cap. Change</td> <td>33, 68, 100, 180, 360, 680 (pF)</td> <td>within ±15%</td> </tr> <tr> <td>1000, 3300 (pF)</td> <td>within ±30%</td> </tr> </tbody> </table>	Appearance	No damage		Cap. Change	33, 68, 100, 180, 360, 680 (pF)	within ±15%	1000, 3300 (pF)	within ±30%	It should be soldered on the Paper-phenol substrate. (t=1.6mm)  Deflection: 3.0mm Keeping Time: 30s
Appearance	No damage										
Cap. Change	33, 68, 100, 180, 360, 680 (pF)	within ±15%									
	1000, 3300 (pF)	within ±30%									
5	Vibration	Meet Table 2, above.	It should be soldered on the substrate. Oscillation Frequency: 10 to 2000 to 10Hz for 20 min. Total Amplitude: 1.5mm or Acceleration amplitude 49m/s ² whichever is smaller. Testing Time: A period of 2 hours in each of 3 mutually perpendicular directions (Total 6 hrs.)								

Specifications and Test Methods

3. Environment Performance (It should be soldered on the substrate.)

No.	Item	Specifications	Test Methods														
1	Humidity	Meet Table 4. Table 4	Temperature: 85±2°C Humidity: 85% (RH) Time: 1000 hrs. (±4 ^h ₈ hrs.) Then measured after exposure in room condition for 4 to 48 hrs.														
2	Heat Life	<table border="1"> <tr> <td>Appearance</td> <td colspan="2">No damage</td> </tr> <tr> <td rowspan="2">Cap. Change</td> <td>33, 68, 100, 180, 360, 680 (pF)</td> <td>within ±15%</td> </tr> <tr> <td>1000, 3300 (pF)</td> <td>within ±30%</td> </tr> <tr> <td>I.R.</td> <td colspan="2">100MΩ min.</td> </tr> <tr> <td>Withstanding Voltage</td> <td colspan="2">No damage</td> </tr> </table>	Appearance	No damage		Cap. Change	33, 68, 100, 180, 360, 680 (pF)	within ±15%	1000, 3300 (pF)	within ±30%	I.R.	100MΩ min.		Withstanding Voltage	No damage		Temperature: 125±2°C Test Voltage: 33 to 680 (pF): Rated Voltage×200% 1000 to 3300 (pF): Rated Voltage×150% Time: 1000 hrs. (±4 ^h ₈ hrs.) Then measured after exposure in room condition for 4 to 48 hrs.
Appearance	No damage																
Cap. Change	33, 68, 100, 180, 360, 680 (pF)	within ±15%															
	1000, 3300 (pF)	within ±30%															
I.R.	100MΩ min.																
Withstanding Voltage	No damage																
3	Cold Resistance		Temperature: -55±2°C Time: 500hrs. (±2 ^h ₀ hrs.) Then measured after exposure in room condition for 4 to 48 hrs.														
4	Temperature Cycle	Meet Table 2, previous page.	1 Cycle 1 step: -55±3°C/30±3 minutes 2 step: Room Temperature/within 5 minutes 3 step: +125±3°C/30±3 minutes 4 step: Room Temperature/within 5 minutes Total of 500 cycles Then measured after exposure in room condition for 4 to 48 hrs.														

2

On-Board Type (DC) EMI Suppression Filters (EMIFIL®) for Automotive



Chip Common Mode Choke Coils Part Numbering

Chip Common Mode Choke Coils for Automotive

(Part Number)

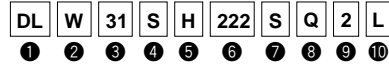

① Product ID

Product ID	
DL	Chip Common Mode Choke Coils

② Structure

Code	Structure
W	Winding Type

③ Dimensions (L×W)

Code	Dimensions (L×W)	EIA
31	3.2×1.6mm	1206
43	4.5×3.2mm	1812

④ Type

Code	Type
S	Magnetically Shielded One Circuit Type

⑤ Category

Code	Category
H	For Automotive

⑥ Impedance (DLW31S)

Typical impedance at 100MHz is expressed by three figures. The unit is in ohm (Ω). The first and second figures are significant digits, and the third figure expresses the number of zeros which follow the two figures.

⑥ Inductance (DLW43S)

Expressed by three-figures. The unit is micro-henry (μH). The first and second figures are significant digits, and the third figure expresses the number of zeros which follow the two figures.

⑦ Circuit

Code	Circuit
S	Expressed by a letter.
X	

⑧ Features

Code	Features
Q	Expressed by a letter.
K	
P	

⑨ Number of Signal Lines

Code	Number of Signal Lines
2	Two Lines

⑩ Packaging

Code	Packaging	Series
K	Embossed Taping (ϕ 330mm Reel)	DLW43S
L	Embossed Taping (ϕ 180mm Reel)	All Series
B	Bulk	

On-Board Type (DC) EMI Suppression Filters (EMIFIL®) for Automotive



Chip Common Mode Choke Coil DLW31S/43S Series

DLW31S Series

DLW31S series is a high performance wound type chip common mode choke coil.

■ Features

1. DLW31S is the small size (3.2x1.6x1.9mm).
2. Suitable for noise suppression at car area networks like CAN (Controller Area Network) bus.
3. DLW31S has high common mode impedance so it is suitable for noise suppression through wide frequency range.
4. Wide operating temperature range (-40 to +125 degrees C)

■ Applications

Noise suppression at car area networks like CAN bus or car navigation system.

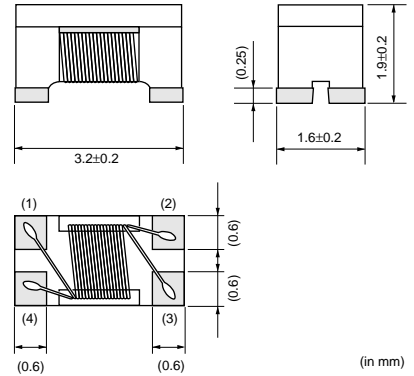

(in mm)

Part Number	Common Mode Impedance (at 100MHz/20 degree C) (ohm)	Rated Current (mA)	Rated Voltage (Vdc)	Insulation Resistance (min.) (M ohm)	Withstand Voltage (Vdc)	DC Resistance (ohm)
DLW31SH222SQ2	2200 ±25%	80	32	10	80	1.6 ±20%

Operating Temperature Range: -40°C to 125°C

■ Equivalent Circuit

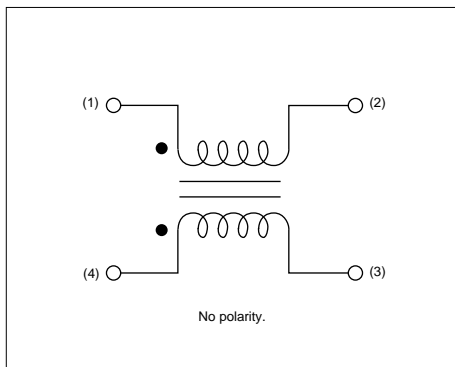

■ Impedance - Frequency Characteristics

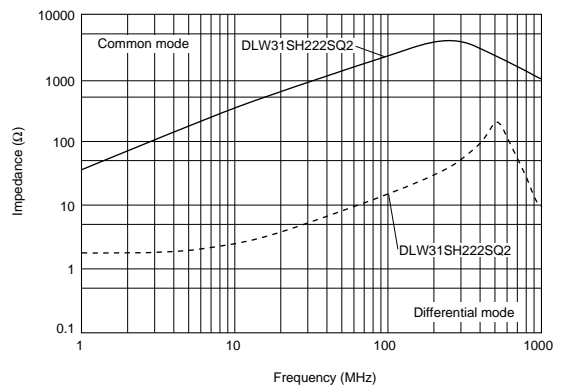

DLW43S_XK Series

■ Features

1. Small size: L4.5xW3.2xT2.6mm (EIA code: 1812)
 Tolerance: +/-0.2mm
2. It realized common mode inductance of 100microH (at 1MHz) though it is small size.
3. Common mode inductance items of 100microH and 51microH, and they can be used for each applications.

■ Applications

For Automotive.
 Common mode noise suppression of automotive LAN for Flex Ray, CANBUS.

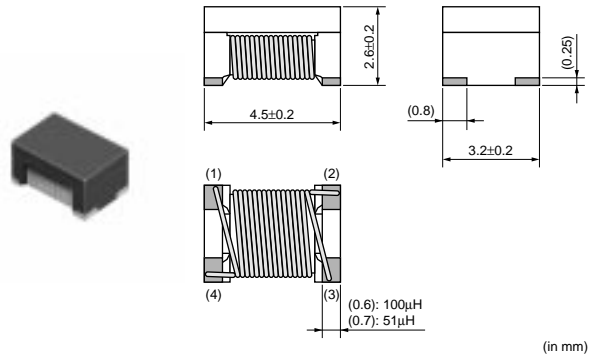

3

Part Number	Common Mode Inductance (μH)	Rated Current (mA)	Rated Voltage (Vdc)	Insulation Resistance (min.) (M ohm)	Withstand Voltage (Vdc)	DC Resistance (ohm)
DLW43SH510XK2	51 -30%/+50% (at 1MHz)	230	50	10	125	1.0 max.
DLW43SH101XK2	100 -30%/+50% (at 1MHz)	200	50	10	125	2.0 max.

Operating Temperature Range: -40°C to 125°C

■ Equivalent Circuit

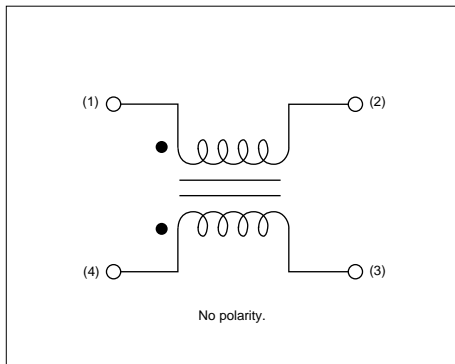

■ Impedance - Frequency Characteristics

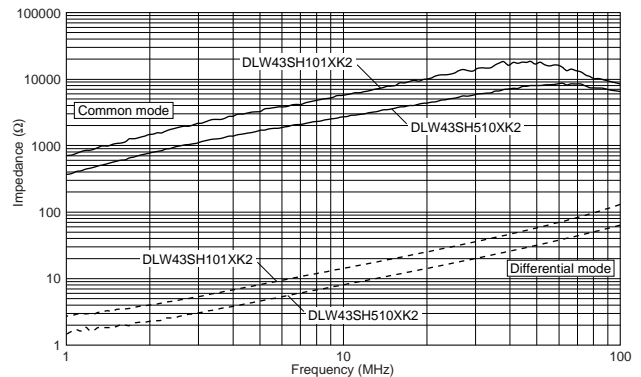

DLW43S_XP Series

■ Features

1. Small size: L4.5xW3.2xT2.7mm (EIA code: 1812)
 Tolerance: +/-0.2mm
2. It realized common mode inductance of 100microH (at 0.1MHz) though it is small size.
3. Suitable for noise suppression from low frequency range (0.1MHz).

■ Applications

For Automotive.
 Common mode noise suppression of automotive LAN for Flex Ray etc.

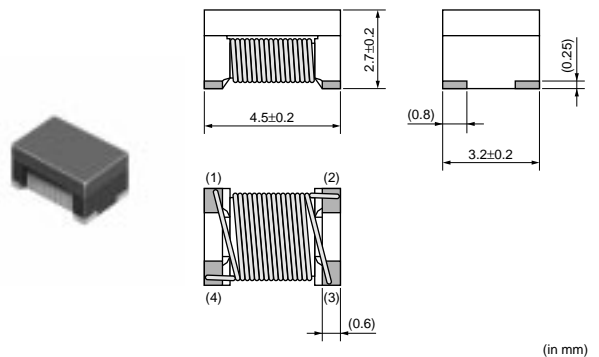

Part Number	Common Mode Inductance (μH)	Rated Current (mA)	Rated Voltage (Vdc)	Insulation Resistance (min.) (M ohm)	Withstand Voltage (Vdc)	DC Resistance (ohm)
DLW43SH101XP2	100 -30%/+80% (at 0.1MHz)	170	50	10	125	2.0 max.

Operating Temperature Range: -40°C to 125°C

■ Equivalent Circuit

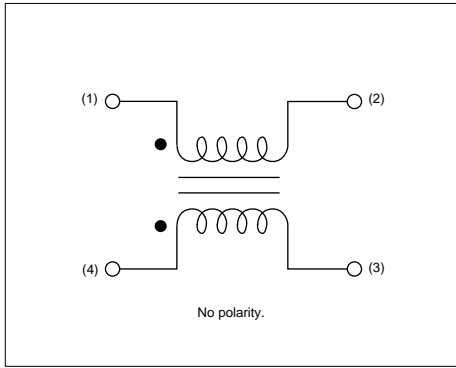

■ Impedance - Frequency Characteristics

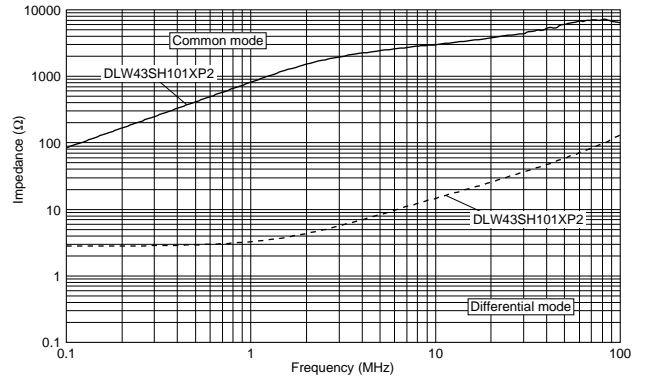

Specifications and Test Methods

■ Test and Measurement Conditions

<Unless otherwise specified>

Temperature: Ordinary Temp. 15 to 35°C
 Humidity: Ordinary Humidity 25 to 85% (RH)

<In case of doubt>

Temperature: 20±2°C
 Humidity: 60 to 70% (RH)
 Atmospheric Pressure: 86 to 106kPa

■ Specifications



1. Electrical Performance

No.	Item	Specifications	Test Methods
1	Common Mode Impedance (Zc) *1	Within the specified tolerance.	Measuring Equipment: Agilent 4291A or the equivalent Measuring Frequency: 100±1MHz
2	Common Mode Inductance (Lc) *2		Measuring Equipment: Agilent 4294A or the equivalent Measuring Frequency: 1MHz or 0.1MHz (DLW43SH101XP2)
3	Insulation Resistance (I.R.)	10MΩ min.	Measuring Voltage: Rated Voltage Charging Time: 1 minute max.
4	Withstanding Voltage	Products should not be damaged.	Test Voltage: 2.5 times for Rated Voltage Tsting Time: 1 to 5 s Charge/Discharge Current: 1mA max.
5	DC Resistance	Meet the initial value specification.	Measuring Current: 10mA max. (In case of doubt in the above mentioned standard conditions, measure by 4 terminal methods.)

*1 DLW31S only.

*2 DLW43S only.

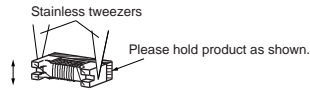
2. Mechanical Performance

No.	Item	Specifications	Test Methods
1	Appearance and Dimensions	Meet dimensions.	Visual Inspection and measured with micrometer.
2	Solderability	The electrodes should be at least 90% covered with new solder coating.	Flux: Ethanol solution of rosin, 25wt% includes activator equivalent to 0.06 to 0.10wt% chlorine Pre-heating: 150±5°C, 60±5s Solder: ①Sn/Pb=60/40 ②Sn-3.0Ag-0.5Cu solder Solder Temperature: ①230±5°C ②245±3°C Immersion Time: ①3±0.5s ②4±1s Immersion and emersion rates: 25mm/s 
3	Resistance to Soldering Heat	Meet Table 1, next page.	Flux: Ethanol solution of rosin, 25wt% includes activator equipment to 0.06 to 0.10wt% chlorine Pre-heating: 150±5°C, 60±5s Solder: Sn/Pb=60/40 or Sn-3.0Ag-0.5Cu solder Solder Temperature: 260±5°C Immersion Time: 10±0.5s Immersion and emersion rates: 25mm/s Then measured after exposure in room condition for 4 to 48 hrs.
4	Bonding Strength	No evidence of coming off substrate. Products should not be mechanically damaged.	It should be soldered on the substrate. Applying Force (F): 10N (DLW31S Series) 17.7N (DLW43S Series) Applying Time: 5±1s (DLW31S Series) 60s (DLW43S Series) 

Continued on the following page. 

Specifications and Test Methods

Continued from the preceding page.

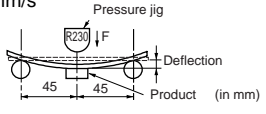
No.	Item	Specifications	Test Methods
5	Bending Strength	Meet Table 1, below.	It should be soldered on the Glass-epoxy substrate. (t=1.0mm DLW31S Series) (t=1.6mm DLW43S Series) Deflection (n): 2.0mm Keeping time: 5s (DLW31S Series) 60s (DLW43S Series) Speed of Applying Force: 0.5mm/s 
6	Vibration		It should be soldered on the substrate. Oscillation Frequency: 10 to 2000 to 10Hz for 20 min. Total Amplitude 1.5mm or acceleration amplitude 49m/s ² whichever is smaller. (DLW31S Series) Total Amplitude 3.0mm or acceleration amplitude 245m/s ² whichever is smaller. (DLW43S Series) Testing Time: A period of 4 hrs. in each of 3 mutually perpendicular directions. (Total 12 hrs.)

3

3. Environmental Performance (It should be soldered on the substrate.)

No.	Item	Specifications	Test Methods
1	Humidity	Meet Table 1, below.	Temperature: 85±2°C Humidity: 85% (RH) Time: 1000hrs. (±48 hrs.) Then measured after exposure in room condition for 4 to 48 hrs.
2	Heat Life		Temperature: 125±2°C Applying Current: Rated Current Time: 1000hrs. (±48 hrs.) Then measured after exposure in room condition for 4 to 48 hrs.
3	Cold Resistance		Temperature: -40± 2°C Time: 1000hrs. (±48 hrs.) Then measured after exposure in room condition for 4 to 48 hrs.
4	Temperature Cycle		1 Cycle Step 1: -40±3°C/30±3 minutes Step 2: Room Temperature/within 5 minutes (DLW31S Series) Room Temperature/within 10 to 15 minutes (DLW43S Series) Step 3: +125±3°C/30±3 minutes Step 4: Room Temperature/within 5 minutes (DLW31S Series) Room Temperature/within 10 to 15 minutes (DLW43S Series) Total of 1000 cycles (DLW31S Series) Total of 300 cycles (DLW43S Series) Then measured after exposure in room condition for 4 to 48 hrs.

Table 1

Appearance	No damage
Common Mode Impedance Change	within ±20% (DLW31S Series)
Common Mode Inductance	Meet the initial value specification. (DLW43S Series)
Insulation Resistance	10MΩ min.
DC Resistance	Meet the initial value specification. (DLW43S Series)
Withstanding Voltage	No damage

Continued on the following page. ↗

Specifications and Test Methods

☐ Continued from the preceding page.

4. Test Terminal (When measuring and supplying the voltage, the following terminal is applied.)

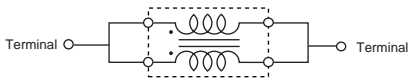
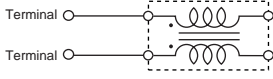
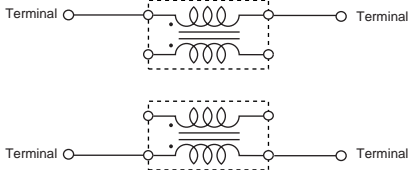
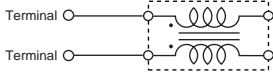
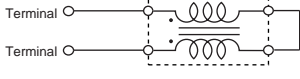
No.	Item	Terminal to be Tested
1	Common Mode Impedance (Measurement Terminal) Common Mode Inductance (Measurement Terminal)	
2	Withstanding Voltage (Measurement Terminal)	
3	DC Resistance (Measurement Terminal)	
4	Insulation Resistance (Measurement Terminal)	
5	Heat Life (Supply Terminal)	

■ Measuring Method for Common Mode Impedance

Measured common mode impedance may include measurement error due to stray capacitance, residual inductance of test fixture.

To correct this error, the common mode impedance should be calculated as follows;

- (1) Measure admittance of the fixture (opened), G_o B_o .
- (2) Measure impedance of the fixture (shorted), R_s X_s .
- (3) Measure admittance of the specimen, G_m B_m .
- (4) Calculate corrected impedance $|Z|$ using the formula below.

$$|Z| = (R_x^2 + X_x^2)^{1/2}$$

Where

$$R_x = \frac{G_m - G_o}{(G_m - G_o)^2 + (B_m - B_o)^2} - R_s$$

$$X_x = \frac{-(B_m - B_o)}{(G_m - G_o)^2 + (B_m - B_o)^2} - X_s$$

On-Board Type (DC) EMI Suppression Filters (EMIFIL®) for Automotive



Block Type EMIFIL® BNX024H/025H/012H Series

Block Type EMIFIL® SMD Type

BNX024H/025H (Block Type EMIFIL for automotive) is EMI suppression filter supporting large current, wide frequency.

And it also support SMD mounting.

This product is effective for noise suppression for DC switching line of automotive device and FA/OA device, because it covers wide temperature range from -55C degrees to 125 C degrees.

■ Features

1. Supporting large current (15A)
2. Supporting wide frequency range
 From 50kHz to 1GHz:35dB min.(BNX025)
3. Suitable for miniaturization with SMD shape.

■ Applications

Automotive devices/Displays (PDP/LCD-TV)/
 Digital AV equipments/Amusement equipments/
 PC peripheral equipments/Industry equipments/
 Measurement equipments/Power supplies

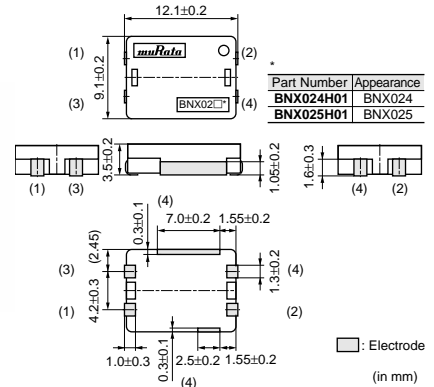

Part Number	Rated Voltage (Vdc)	Withstand Voltage (Vdc)	Rated Current (A)	Insulation Resistance (min.) (M ohm)	Insertion Loss
BNX024H01	50	125	15	100	100kHz to 1GHz:35dB min. (20 to 25 degrees C line impedance=50 ohm)
BNX025H01	25	62.5	15	50	50kHz to 1GHz:35dB min. (20 to 25 degrees C line impedance=50 ohm)

Operating Temperature Range: -55°C to 125°C

■ Equivalent Circuit

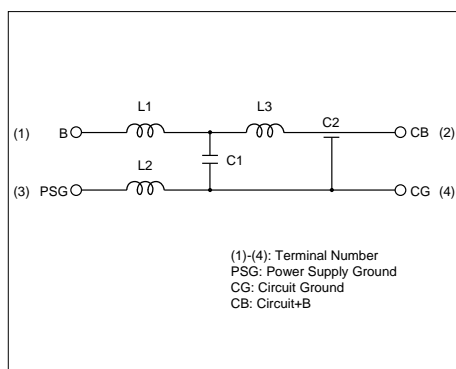

■ Insertion Loss Characteristics

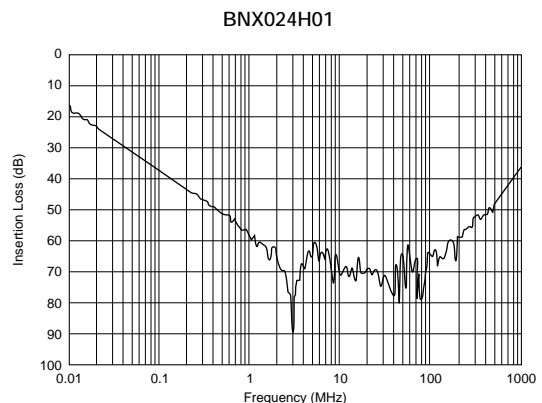

Continued on the following page.

Continued from the preceding page.

■ Insertion Loss Characteristics

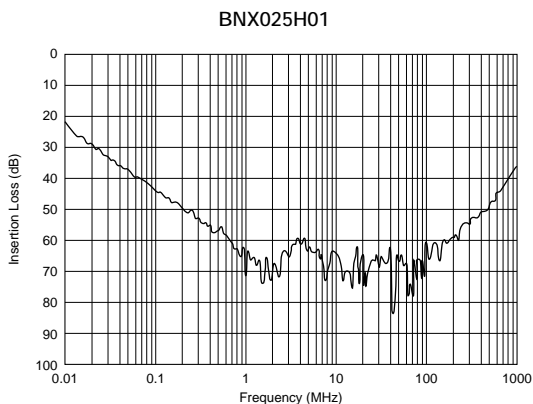

■ Derating of Rated Current

In operating temperatures exceeding +85°C, derating of current is necessary for BNX024H/025H series. Please apply the derating curve shown in chart according to the operating temperature.

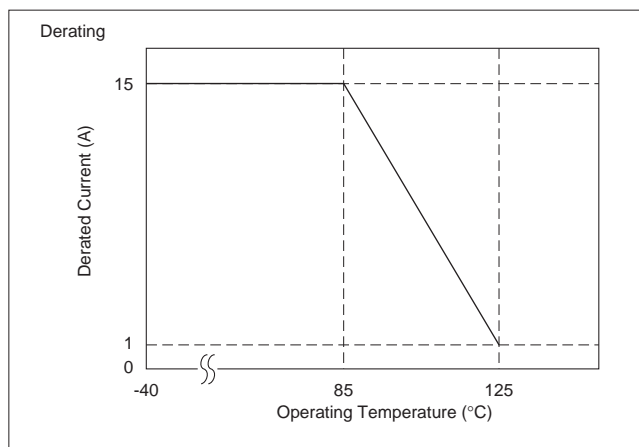

4

Block Type EMIFIL® Lead Type

BNX012H series is noise suppression filter and ESD surge protection filter for Automotive. Suitable for the power supply circuits which is large current and wide frequency range.

■ Features

1. Large rated current(15A) and Low DC Resistance (0.8m ohm-Typ.)
2. High insertion loss characteristic over a wide frequency range of 1MHz to 1GHz.
3. Low profile (height: 8.0mm except lead terminal)

■ Applications

Noise suppression and ESD surge protection for power lines such as ECU, DC-DC Converters, and Inverter circuits.

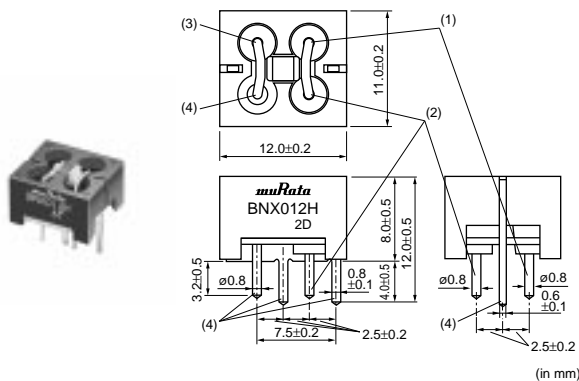

Part Number	Rated Voltage (Vdc)	Withstand Voltage (Vdc)	Rated Current (A)	Insulation Resistance (min.) (M ohm)	Insertion Loss
BNX012H01	50	125	15	500	1MHz to 1GHz:40dB min. (20 to 25 degrees C line impedance=50 ohm)

Operating Temperature Range: -55°C to 125°C

■ Equivalent Circuit

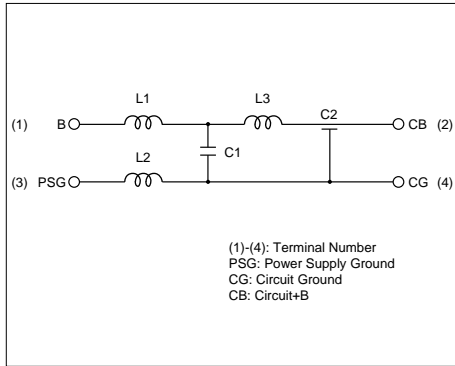

■ Insertion Loss Characteristics

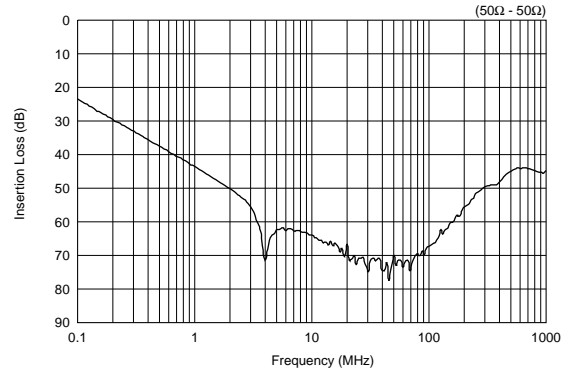

■ Derating of Rated Current

● Rating

In operating temperatures exceeding +85°C, derating of current is necessary for BNX012H series. Please apply the derating curve shown in chart according to the operating temperature.

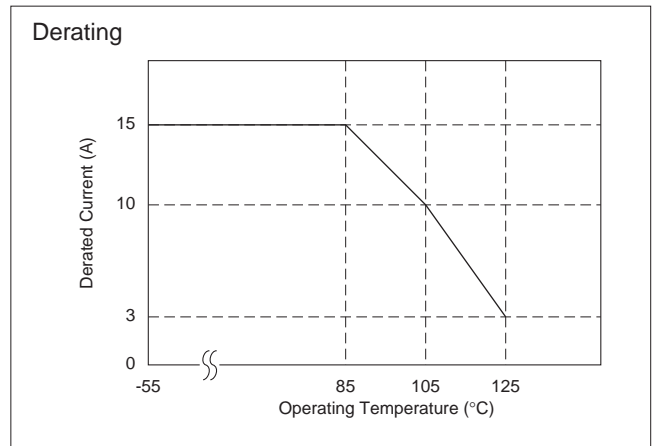

4

● Connecting ± Power Line

In case of using ± power line, please connect to each terminal as shown.

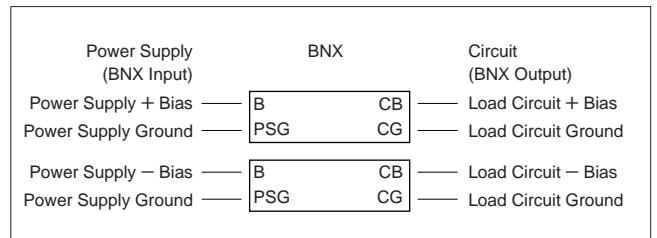

BNX024H/025H series Specifications and Test Methods

■ Test and Measurement Conditions

<Unless otherwise specified>

Temperature: Ordinary Temp. 15 to 35°C

Humidity: Ordinary Humidity 25 to 85% (RH)

<In case of doubt>

Temperature: 20°C±2°C

Humidity: 60 to 70% (RH)

Atmospheric pressure: 86 to 106kPa

■ Specifications

1. Electrical Performance

No.	Item	Specifications	Test Methods
1	Insulation Resistance	BNX024H01: 100MΩ min. BNX025H01: 50MΩ min.	Measured at DC rated voltage between terminal (1)(2) and (3)(4). Time: 60s max. Charging Current: 50mA max. Measuring Equipment: R8340A or the equivalent
2	Dielectric Strength	Filter should not fail.	Withstanding voltage shall be applied between terminal (1)(2) and (3)(4). Test Voltage: BNX024H01 125V (DC) BNX025H01 62.5V (DC) Time: 5±1s Charging current: 50mA max.
3	DC Resistance	0.43±0.20mΩ	Measured by the way of 4 terminal method between (1) and (2) and between (3) and (4).
4	Capacitance	BNX024H01: 4.7μF±15% BNX025H01: 10μF±15%	Measured by the following condition between Terminal (1)(2) and (3)(4). Frequency: 1±0.1kHz Voltage: 1V (rms) max. Measuring Equipment: HP4278A or the equivalent
5	Insertion Loss	BNX024H01: 35dB min. (100kHz to 1GHz) BNX025H01: 35dB min. (50kHz to 1GHz)	<p>*Method of measurement based on MIL-STD-220</p> <p>Insertion Loss = $-20 \log E_1/E_0$ (dB) E_0: Level without FILTER (short) E_1: Level with FILTER</p>
6	Voltage Drop	45mV max.	<p>After soldering the part on the test substrate, measure the voltage with passing the rated current as shown in the schematic below.</p> <p>Where the terminals of the part shall be connected as follows: Referring to the terminal No. shown in item 5, connect terminal No. (2) and (4) by soldering copper wire with diameter more than 1mm / length less than 6mm. Then connect terminal No. (1) as (i) and terminal No. (3) as (ii) the measurement circuit as mentioned above. The probe for measuring the voltage shall be touched on the solder fillet of (1)(3).</p>

Continued on the following page. ↗

BNX024H/025H series Specifications and Test Methods

☐ Continued from the preceding page.

2. Mechanical Performance

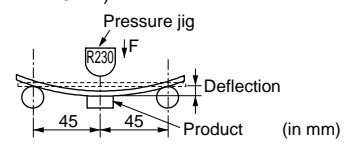
No.	Item	Specifications	Test Methods							
1	Appearance and Dimensions	Meet dimensions.	Visual Inspection and measured with micrometer caliper and slid caliper.							
2	Marking	Marking can be read easily.	It is inspected Visually.							
3	Reflow Solderability	Appropriate solder fillet is formed.	Confirm the solder mounting condition after mounting based on standard solder mounting method.							
4	Resistance to Soldering Heat	Meet Table 1. Table 1	Soldering Iron: 100W max. Tip Temperature: 450±5°C Soldering Time: 5s, 2 times Do not touch the products directly with the tip of the soldering iron.							
5	Bending Strength		It shall be soldered on the glass-epoxy substrate. (100mm x 40mm x 1.6mm)							
			<table border="1" style="width: 100%;"> <tr> <td>Appearance</td> <td>No damaged</td> </tr> <tr> <td>Insulation Resistance</td> <td>BNX024H01: 100MΩ min. BNX025H01: 50MΩ min.</td> </tr> <tr> <td>Dielectric Strength</td> <td>No failure</td> </tr> <tr> <td>Capacitance Change</td> <td>Within ±7.5%</td> </tr> </table>  <p>Deflection: 2mm Keeping Time: 30s Speed: 0.5mm/s</p>	Appearance	No damaged	Insulation Resistance	BNX024H01: 100MΩ min. BNX025H01: 50MΩ min.	Dielectric Strength	No failure	Capacitance Change
Appearance	No damaged									
Insulation Resistance	BNX024H01: 100MΩ min. BNX025H01: 50MΩ min.									
Dielectric Strength	No failure									
Capacitance Change	Within ±7.5%									
6	Drop	Meet Table 2. Table 2	It shall be dropped on concrete or steel board. Method: free fall Height: 1m The Number of Time: 10 times							
7	Vibration		It shall be soldered on the glass-epoxy substrate. Oscillation Frequency: 10 to 2000 to 10Hz for 20 minutes Total amplitude 3.0mm or Acceleration amplitude 196m/s ² whichever is smaller. Time: A period of 3 hours in each of 3 mutually perpendicular directions. (Total 9 hours)							
8	Shock		It shall be soldered on the glass-epoxy substrate. Acceleration: 14700m/s ² Normal duration: 0.5ms Waveform: Half-sine wave Direction: 6 direction Testing Time: 3 times for each direction							

3. Environmental Performance (It should be soldered on the substrate.)

No.	Item	Specifications	Test Methods
1	Biased Humidity	Meet Table 3. Table 3	Temperature: 85±2°C Humidity: 80 to 85% (RH) Voltage: Rated Voltage Time: 1000 ⁺⁴ ₀ hrs. Then measure values after exposure in room condition for 48±4 hours.
2	Heat Life	Meet Table 4. Table 4	Temperature: 125±2°C Voltage: Rated Voltage x 2 Time: 1000 ⁺⁴ ₀ hrs. Then measure values after exposure in room condition for 48±4 hours.
3	Heat Shock	Meet Table 4.	1 Cycle: 1 step: -55± ⁰ ₃ °C/30± ³ ₀ min. 2 step: Room Temperature/within 0.5 min. 3 step: +125± ³ ₀ °C/30± ³ ₀ min. 4 step: Room Temperature/within 0.5 min. Total Cycles: 1000 cycles Then measure values after exposure in room condition for 48±4 hours.

BNX012H series Specifications and Test Methods

■ Test and Measurement Conditions

<Unless otherwise specified>

Temperature: Ordinary Temp. 15 to 35°C

Humidity: Ordinary Humidity 25 to 85% (RH)

<In case of doubt>

Temperature: 20°C±2°C

Humidity: 60 to 70% (RH)

Atmospheric pressure: 86 to 106kPa

■ Specifications

1. Electrical Performance

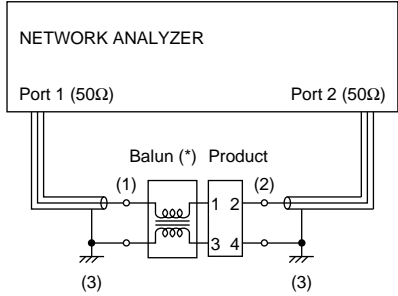
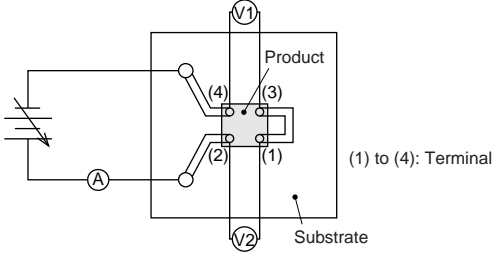
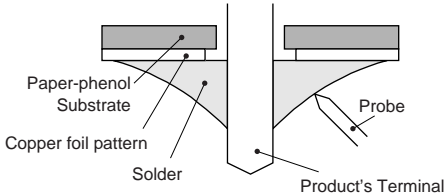
No.	Item	Specifications	Test Methods
1	Insulation Resistance	500MΩ min.	Measured at DC rated voltage between terminal (1)(2) and (3)(4). Voltage: 50Vdc Charging time: 2 minutes Suitable resistor: 1MΩ
2	Dielectric Strength	Filter should not fail.	Test voltage should be applied between terminal (1)(2) and (3)(4). Test Voltage: 125Vdc Testing Time: 1 to 5s Charge/Discharge Current: 50mA max.
3	Capacitance	1.0μF±15%	Measured at the following conditions between terminal (1)(2) and (3)(4). Frequency: 1.0±0.1kHz Voltage: 1Vrms max.
4	Insertion Loss	40dB min. (1MHz to 1GHz)	Measured by the following circuit. Measuring Equipment: R3767 C (manufactured by ADVANTEST) or the equivalent. Sample: build product into Balun.  (*): It uses the Balun or 1 to 1 transformer.
5	Voltage Drop	35mV max.	Rated Current: 15 A Substrate: 100x100x1.6mm (paper-phenol) Soldering: Insert the terminals into the holes on P.C. board completely. Voltage Drop Value: V1+V2  (1) to (4): Terminal Substrate Probe of each voltmeter should contact the center of soldering parts as shown in the following figure. 

Continued on the following page. 

BNX012H series Specifications and Test Methods

☐ Continued from the preceding page.

2. Mechanical Performance

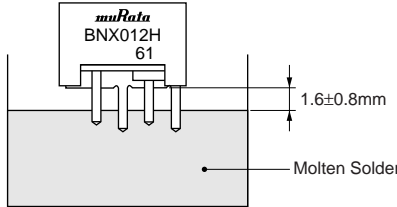
No.	Item	Specifications	Test Methods								
1	Appearance and Dimensions	Meet dimensions.	Visual Inspection and measured with micrometer.								
2	Marking	Marking can be read easily.	It is inspected Visually.								
3	Solderability	The lead is covered with a new solder coating at least 95% of the total surface of the immersed part.	Flux: Ethanol solution of rosin, 25(wt)% Pre-Heating: 150±10°C, 60 to 90s Solder: Sn-3.0Ag-0.5Cu Solder Temperature: 235± $\frac{0}{5}$ °C Immersion Time: 5±0.5s 								
4	Resistance to Soldering Heat	Meet Table 1. Table 1 <table border="1" style="width: 100%; border-collapse: collapse;"> <tr> <td style="text-align: center;">Appearance</td> <td style="text-align: center;">No damage</td> </tr> <tr> <td style="text-align: center;">Insulation Resistance</td> <td style="text-align: center;">500MΩ min.</td> </tr> <tr> <td style="text-align: center;">Dielectric Strength</td> <td style="text-align: center;">No failure</td> </tr> <tr> <td style="text-align: center;">Capacitance Change</td> <td style="text-align: center;">Within ±7.5%</td> </tr> </table>	Appearance	No damage	Insulation Resistance	500MΩ min.	Dielectric Strength	No failure	Capacitance Change	Within ±7.5%	Flux: Ethanol solution of rosin, 25(wt)% Pre-Heating: 150±10°C, 60 to 90s Solder: Sn-3.0Ag-0.5Cu Solder Temperature: 270±10°C Immersion Time: 10± $\frac{0}{5}$ s Then measure values after exposure in room condition for 24 to 48 hrs.
Appearance	No damage										
Insulation Resistance	500MΩ min.										
Dielectric Strength	No failure										
Capacitance Change	Within ±7.5%										
5	Vibration	Meet Table 2. Table 2 <table border="1" style="width: 100%; border-collapse: collapse;"> <tr> <td style="text-align: center;">Appearance</td> <td style="text-align: center;">No damage</td> </tr> <tr> <td style="text-align: center;">Insulation Resistance</td> <td style="text-align: center;">500MΩ min.</td> </tr> <tr> <td style="text-align: center;">Dielectric Strength</td> <td style="text-align: center;">No failure</td> </tr> <tr> <td style="text-align: center;">Capacitance</td> <td style="text-align: center;">1.0μF±15%</td> </tr> </table>	Appearance	No damage	Insulation Resistance	500MΩ min.	Dielectric Strength	No failure	Capacitance	1.0μF±15%	It should be soldered on the substrate. Oscillation Frequency: 10 to 2000 to 10Hz for 20min. Testing Time: A period of 3 hours in each of 3 mutually perpendicular directions. (Total 9 hrs.) Total amplitude 1.5mm or Acceleration amplitude 196m/s ² whichever is smaller. Then measure values after exposure in room condition for 4 to 24 hrs.
Appearance	No damage										
Insulation Resistance	500MΩ min.										
Dielectric Strength	No failure										
Capacitance	1.0μF±15%										

4

3. Environmental Performance (It should be soldered on the substrate.)

No.	Item	Specifications	Test Methods						
1	Humidity	Meet Table 1.	Temperature: 85±2°C Humidity: 80 to 85%(RH) Time: 1000± $\frac{4}{8}$ hrs. Remove the drops and then measure values after exposure in room condition for 24 to 48 hrs.						
2	Biased Humidity	Meet Table 3. Table 3	Temperature: 85±2°C Humidity: 80 to 85%(RH) Test Voltage: 50Vdc Time: 1000± $\frac{4}{8}$ hrs. Remove the drops and then measure values after exposure in room condition for 24 to 48 hrs.						
3	Heat Life	<table border="1" style="width: 100%; border-collapse: collapse;"> <tr> <td style="text-align: center;">Appearance</td> <td style="text-align: center;">No damage</td> </tr> <tr> <td style="text-align: center;">Insulation Resistance</td> <td style="text-align: center;">50MΩ min.</td> </tr> <tr> <td style="text-align: center;">Capacitance Change</td> <td style="text-align: center;">Within ±12.5%</td> </tr> </table>	Appearance	No damage	Insulation Resistance	50MΩ min.	Capacitance Change	Within ±12.5%	Temperature: 125±2°C Test Voltage: 100Vdc Time: 1000± $\frac{4}{8}$ hrs. Then measure values after exposure in room condition for 24 to 48 hrs.
Appearance	No damage								
Insulation Resistance	50MΩ min.								
Capacitance Change	Within ±12.5%								
4	Cold Resistance		Temperature: -55±2°C Time: 1000± $\frac{4}{8}$ hrs. Then measure values after exposure in room condition for 24 to 48 hrs.						
5	Temperature Cycle	Meet Table 1.	1 Cycle: 1 step: -55± $\frac{0}{3}$ °C/30 minutes 2 step: Room Temperature/within 1 minute 3 step: +125± $\frac{0}{3}$ °C/30 minutes 4 step: Room Temperature/within 1 minute Total of 1000 cycles Then measure values after exposure in room condition for 24 to 48 hrs.						

Chip EMIFIL® ⚠Caution/Notice

■ ⚠Caution (Rating)

1. Do not use products beyond the rated current and rated voltage as this may create excessive heat and deteriorate the insulation resistance.
2. Be sure to provide an appropriate fail-safe function on your product to prevent a second damage that may be caused by the abnormal function or the failure our product.

■ ⚠Caution (Soldering and Mounting)

1. Self-heating

Please provide special attention when mounting chip "EMIFIL" (BLM_P) series in close proximity to other products that radiate heat.

The heat generated by other products may deteriorate the insulation resistance and cause excessive heat in this component.

2. Mounting Direction

Mount Chip Common Mode Choke Coils (DLW31S/43S) in right direction. Wrong direction, which is 90 degrees rotated from right direction, causes not only open or short circuit but also flames or other serious trouble.

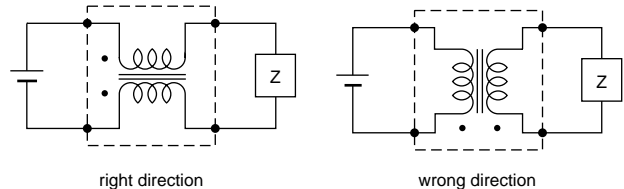

■ Notice (Storage and Operating Condition)

< Operating Environment >

Do not use products in a chemical atmosphere such as chlorine gas, acid or sulfide gas.

< Storage and Handling Requirements >

1. Storage Period

BLM series should be used within 6 months, the other series should be used within 12 months.

Products to be used after this period should be checked for solderability or bondability with glue.

2. Storage Conditions

(1) Storage temperature: -10 to 40 degrees C

Relative humidity: 30 to 70%

Avoid sudden changes in temperature and humidity.

(2) Do not store products in a chemical atmosphere such as chlorine gas, acid or sulfide gas.

■ Notice (Soldering and Mounting)

1. Washing

Failure and degradation of a product are caused by the washing method. When you wash in conditions that are not in mounting information, please contact Murata engineering.

2. Soldering

Reliability decreases with improper soldering methods. Please solder by the standard soldering conditions shown in mounting information.

3. Mounting on-board with Conductive Glue

BLM18AG_WH is designed for conductive glue mounting method. Please refer to Mounting information.

4. Other

Noise suppression levels resulting from Murata's EMI suppression filters "EMIFIL" may vary, depending on the circuits and ICs used, type of noise, mounting pattern, mounting location, and other operating conditions. Be sure to check and confirm in advance the noise suppression effect of each filter, in actual circuits, etc. before applying the filter in a commercial-purpose equipment design.

Chip EMIFIL® ⚠Caution/Notice

■ Notice (Handling)

1. Resin coating (DLW31S)

Do not make any resin coating DLW31S series.
The impedance value may change due to high cure-stress of resin to be used for coating/ molding products.

An open circuit issue may occur by mechanical stress caused by the resin, amount/ cured shape of resin, or operating condition etc. Some resin contains some impurities or chloride possible to generate chlorine by hydrolysis under some operating condition may cause corrosion of wire of coil, leading to open circuit.

So, please pay your careful attention in selecting resin in case of coating/ molding the products with the resin.

2. Resin coating (DLW43S)

The inductance value may change due to high cure-stress of resin to be used for coating/ molding products.

An open circuit issue may occur by mechanical stress caused by the resin, amount/ cured shape of resin, or operating condition etc. Some resin contains some impurities or chloride possible to generate chlorine by hydrolysis under some operating condition may cause corrosion of wire of coil, leading to open circuit.

So, please pay your careful attention in selecting resin in case of coating/ molding the products with the resin. Prior to use the coating resin, please make sure no reliability issue is observed by evaluating products mounted on your board.

3. Resin coating (Except DLW31S/43S)

It may affect the product's performance when using resin for coating/ molding products, except DLW31S/43S.

So please pay careful attention in selecting resin. Prior to use, please evaluate reliability with the product mounted in your application set.

4. Caution for use (DLW31S/43S)

Sharp material, such as a pair of tweezers, should not touch the winding portion to prevent breaking the wire.

Mechanical shock should not be applied to the products mounted on the board to prevent breaking the core.

Lead Type EMIFIL[®] ⚠Caution/Notice

■ Notice (Rating)

Do not use products beyond the rated current and rated voltage as this may create excessive heat and deteriorate the insulation resistance.

■ Notice (Soldering and Mounting)

Mounting holes should be designed as specified in these specifications. Other designs than shown in these specifications may cause cracks in ceramics which may lead to smoking or firing.

■ Notice (Storage and Operating Condition)

<Operating Environment>

1. Do not use products in a chemical atmosphere such as chlorine gas, acid or sulfide gas.
2. Do not use products near water, oil or organic solvents. Avoid environment where dust or dirt may adhere to product.

<Storage and Handling Requirements>

1. Storage Period

Used the products within 12 months after delivery. Solderability should be checked if this period is exceeded.

2. Storage Conditions

- (1) Storage temperature: -10 to 40 degrees C

Relative humidity: 30 to 70%

Avoid sudden changes in temperature and humidity.

- (2) Do not store products in a chemical atmosphere such as chlorine gas, acid or sulfide gas.

■ Notice (Soldering and Mounting)

1. Washing

Failure and degradation of a product are caused by the washing method. When you wash in conditions that are not in mounting information, please contact Murata engineering.

2. Soldering

Reliability decreases with improper soldering methods. Please solder by the standard soldering conditions shown in mounting information.

3. Other

Noise suppression levels resulting from Murata's EMI suppression filters "EMIFIL" may vary, depending on the circuits and ICs used, type of noise, mounting pattern, mounting location, and other operating conditions. Be sure to check and confirm in advance the noise suppression effect of each filter, in actual circuits, etc. before applying the filter in a commercial-purpose equipment design.

Chip EMIFIL® (Soldering and Mounting)

1. Standard Land Pattern Dimensions

Land Pattern + Solder Resist
 Land Pattern
 Solder Resist

(in mm)

BLM15
BLM18
BLM21
BLM31
BLM41

● Reflow and Flow

BLM Series (Except BLM□□P series)

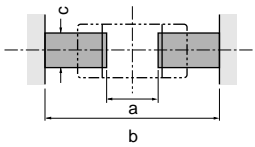

Type	Soldering	a	b	c
BLM15 *1	Reflow	0.4	1.2-1.4	0.5
BLM18 *2 (Except 18PG)	Flow	0.7	2.2-2.6	0.7
	Reflow		1.8-2.0	
BLM21 (Except 21PG)	Flow/ Reflow	1.2	3.0-4.0	1.0
BLM31 (Except 31PG)	Flow/ Reflow	2.0	4.2-5.2	1.2

*1 BLM15 is specially adapted for reflow soldering.

BLM□□P

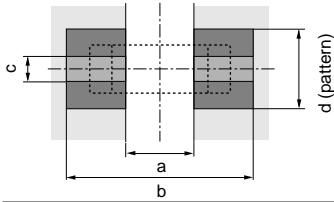

Type	Rated Current (A)	Soldering	a	b	c	Land pad thickness and dimension d		
						18μm	35μm	70μm
BLM18PG	0.5-1.5	Flow/ Reflow	0.7	2.2-2.6 Reflow 1.8-2.0	0.7	0.7	0.7	0.7
	2					1.2	0.7	0.7
	3					2.4	1.2	0.7
BLM21PG	1.5	Flow/ Reflow	1.2	3.0-4.0	1.0	1.0	1.0	1.0
	2					1.2	1.0	1.0
	3					2.4	1.2	1.0
	6					6.4	3.3	1.65
BLM31PG	1.5/2	Flow/ Reflow	2.0	4.2-5.2	1.2	1.2	1.2	1.2
	3					2.4	1.2	1.2
	6					6.4	3.3	1.65
BLM41PG	1-2	Flow/ Reflow	3.0	5.5-6.5	1.2	1.2	1.2	1.2
	3					2.4	1.2	1.2
	6					6.4	3.3	1.65

• Do not apply narrower pattern than listed above to BLM□□P. Narrow pattern can cause excessive heat or open circuit.

*2 BLM18A_WH series is designed for conductive glue mounting method, not for normal soldering method. Please contact us for applicable mounting method for BLM18A_WH series.

NFM21H

● Reflow Soldering
 Chip mounting side

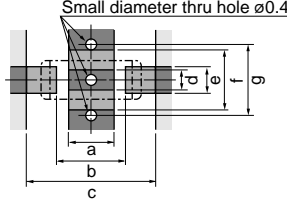

Part Number	Size (mm)						
	a	b	c	d	e	f	g
NFM21H	0.6	1.4	2.6	0.6	0.8	1.9	2.3

The chip EMI filter suppresses noise by conducting the high-frequency noise to ground. Therefore, to get enough noise reduction, feed through holes which are connected to ground-plane should be arranged according to the figure to reinforce the ground pattern.

• NFM21 is specially adapted for reflow soldering.

NFE61H

● Reflow Soldering
 Chip mounting side

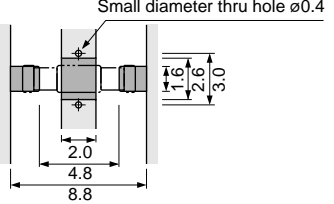

● Flow Soldering (Except NFE61HT332)
 Chip mounting side

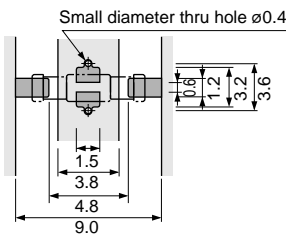

Continued on the following page.

Chip EMIFIL[®] (Soldering and Mounting)

Continued from the preceding page.

 Land Pattern + Solder Resist
 Land Pattern
 Solder Resist (in mm)

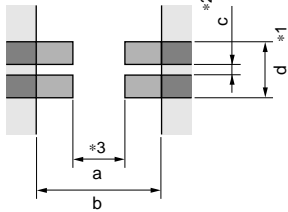
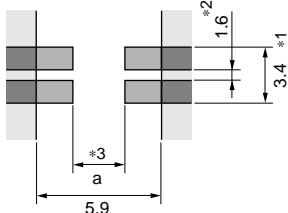
<p>DLW31S</p> <p>●Reflow Soldering</p>  <table border="1" data-bbox="341 622 866 696"> <thead> <tr> <th>Series</th> <th>a</th> <th>b</th> <th>c</th> <th>d</th> </tr> </thead> <tbody> <tr> <td>DLW31S</td> <td>1.6</td> <td>3.7</td> <td>0.4</td> <td>1.6</td> </tr> </tbody> </table>	Series	a	b	c	d	DLW31S	1.6	3.7	0.4	1.6	<p>* 1 : If the pattern is made with wider than 1.6mm (DLW31S) it may result in components turning around, because melting speed is different. In the worst case, short circuit between lines may occur.</p> <p>* 2 : If the pattern is made with less than 0.4mm, in the worst case, short circuit between lines may occur due to spread of soldering paste or mount placing accuracy.</p> <p>* 3 : If the pattern is made with wider than 1.6mm (DLW31S), the bending strength will be reduced.</p> <p>Do not use gilded pattern; excess soldering heat may dissolve metal of a copper wire.</p>
Series	a	b	c	d							
DLW31S	1.6	3.7	0.4	1.6							
<p>DLW43S</p> <p>●Reflow Soldering</p>  <table border="1" data-bbox="341 1032 691 1171"> <thead> <tr> <th>Series</th> <th>a</th> </tr> </thead> <tbody> <tr> <td>DLW43SH510XK2</td> <td>3.0</td> </tr> <tr> <td>DLW43SH101XK2</td> <td rowspan="2">3.2</td> </tr> <tr> <td>DLW43SH101XP2</td> </tr> </tbody> </table>	Series	a	DLW43SH510XK2	3.0	DLW43SH101XK2	3.2	DLW43SH101XP2	<p>* 1 : If the pattern is made with wider than 3.4mm, it may result in components turning around, because melting speed is different. In the worst case, short circuit between lines may be occur.</p> <p>* 2 : If the pattern is made with less than 1.6mm, in the worst case, short circuit between lines may occur due to the spread of soldering paste or mount placing accuracy.</p> <p>* 3 : If the pattern is made with wider, the strength of bending will be reduced.</p> <p>Do not use gilded pattern; excess soldering heat may dissolve metal of a copper wire.</p>			
Series	a										
DLW43SH510XK2	3.0										
DLW43SH101XK2	3.2										
DLW43SH101XP2											

2. Solder Paste Printing and Adhesive Application

When reflow soldering the chip EMI suppression filter, the printing must be conducted in accordance with the following cream solder printing conditions.

If too much solder is applied, the chip will be prone to damage by mechanical and thermal stress from the PCB and may crack. In contrast, if too little solder is applied, there is the potential that the termination strength will be insufficient, creating the potential for detachment.

Standard land dimensions should be used for resist and

copper foil patterns.

When flow soldering the EMI suppression filter, apply the adhesive in accordance with the following conditions.

If too much adhesive is applied, then it may overflow into the land or termination areas and yield poor solderability.

In contrast, if insufficient adhesive is applied, or if the adhesive is not sufficiently hardened, then the chip may become detached during flow soldering process.

(in mm)

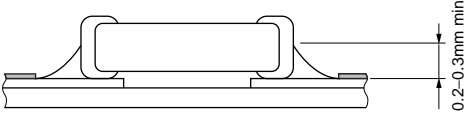
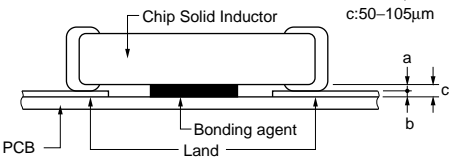
Series	Solder Paste Printing	Adhesive Application
<p>BLM15 BLM18 BLM21 BLM31 BLM41</p>	<p>●Ensure that solder is applied smoothly to a minimum height of 0.2mm to 0.3mm at the end surface of the part.</p> <p>●Coat the solder paste a thickness: 100-200μm</p> 	<p>Coating amount is illustrated in the following diagram.</p> <p>a:20-70μm b:30-35μm c:50-105μm</p> 

Continued on the following page. ↗

Chip EMIFIL® (Soldering and Mounting)

☐ Continued from the preceding page.

(in mm)

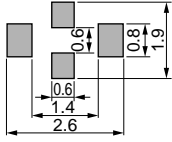
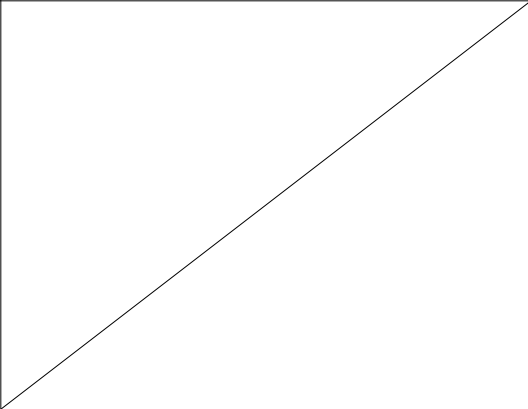
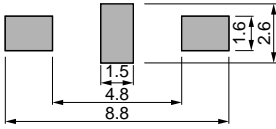
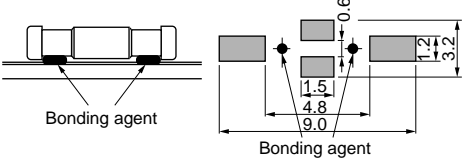
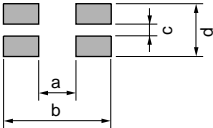
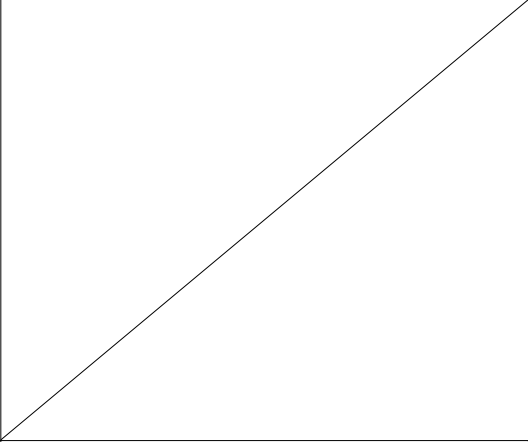
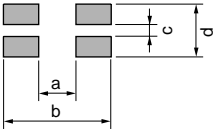
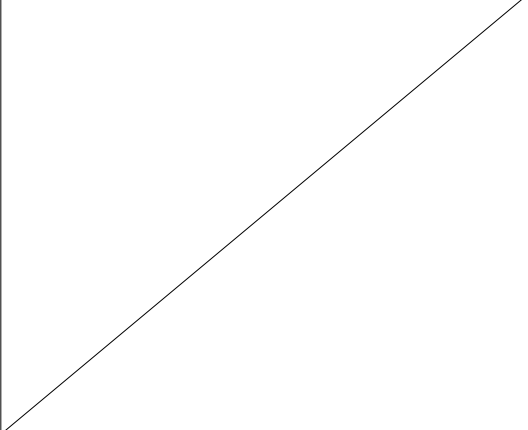
Series	Solder Paste Printing	Adhesive Application										
NFM21H	<ul style="list-style-type: none"> ●Use Sn/Pb=60/40 or Sn-3.0Ag-0.5Cu solder for pattern printing. Use of Sn-Zn based solder will deteriorate performance of products. If using Sn-Zn based solder, please contact Murata in advance. ●Coat the solder paste a thickness: 100-150μm 											
NFE61H	<ul style="list-style-type: none"> ●Use Sn/Pb=60/40 or Sn-3.0Ag-0.5Cu solder for pattern printing. ●Coat the solder paste a thickness: 150-200μm 	<p>Apply 1.0mg of bonding agent at each chip.</p>  <p>*Except NFE61HT332</p>										
DLW31S	<ul style="list-style-type: none"> ●Use Sn/Pb=60/40 or Sn-3.0Ag-0.5Cu solder for pattern printing. ●Coat the solder paste a thickness: 100-150μm <p>*Solderability is subject to reflow condition and thermal conductivity. Please make sure that your product has been evaluated in view of your specifications with our product being mounted to your product.</p>  <table border="1" style="margin-left: auto; margin-right: auto;"> <thead> <tr> <th>Series</th> <th>a</th> <th>b</th> <th>c</th> <th>d</th> </tr> </thead> <tbody> <tr> <td>DLW31S</td> <td>1.6</td> <td>3.7</td> <td>0.4</td> <td>1.6</td> </tr> </tbody> </table>	Series	a	b	c	d	DLW31S	1.6	3.7	0.4	1.6	
Series	a	b	c	d								
DLW31S	1.6	3.7	0.4	1.6								
DLW43S	<ul style="list-style-type: none"> ●Use Sn/Pb=60/40 or Sn-3.0Ag-0.5Cu solder for pattern printing. ●Coat the solder paste a thickness: 150μm <p>*Solderability is subject to reflow condition and thermal conductivity. Please make sure that your product has been evaluated in view of your specifications with our product being mounted to your product.</p>  <table border="1" style="margin-left: auto; margin-right: auto;"> <thead> <tr> <th>Series</th> <th>a</th> <th>b</th> <th>c</th> <th>d</th> </tr> </thead> <tbody> <tr> <td>DLW43S</td> <td>3.0 (510) 3.2 (101)</td> <td>5.9</td> <td>1.6</td> <td>3.4</td> </tr> </tbody> </table>	Series	a	b	c	d	DLW43S	3.0 (510) 3.2 (101)	5.9	1.6	3.4	
Series	a	b	c	d								
DLW43S	3.0 (510) 3.2 (101)	5.9	1.6	3.4								

Continued on the following page. ☐

Chip EMIFIL[®] (Soldering and Mounting)

☐ Continued from the preceding page.

3. Standard Soldering Conditions

(1) Soldering Methods

Use flow and reflow soldering methods only.

Use standard soldering conditions when soldering chip EMI suppression filters.

In cases where several different parts are soldered, each having different soldering conditions, use those conditions requiring the least heat and minimum time.

Solder: H60A H63A solder (JIS Z 3238)

In case of lead-free solder, use Sn-3.0Ag-0.5Cu solder. Use of Sn-Zn based solder will deteriorate performance of products. If using NFM series with Sn-Zn based solder, please contact Murata in advance.

(2) Soldering Profile

- Flow Soldering profile
 (Eutectic solder, Sn-3.0Ag-0.5Cu solder)

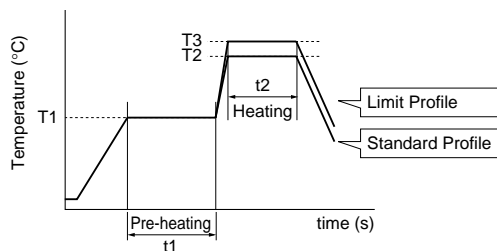

Series	Pre-heating		Standard Profile			Limit Profile		
	Heating		Cycle of flow	Heating		Cycle of flow		
	Temp. (T1)	Time. (t1)		Temp. (T2)	Time. (t2)		Temp. (T3)	Time. (t2)
BLM (Except BLM15)	150°C	60s min.	250°C	4 to 6s	2 times max.	265 ±3°C	5s max.	2 times max.
NFE61H*								

*Except NFE61HT332

Flux:

- Use Rosin-based flux.
 In case of DLW31/43 series, use Rosin-based flux with converting chlorine content of 0.06 to 0.1wt%.
 In case of using RA type solder, products should be cleaned completely with no residual flux.
- Do not use strong acidic flux (with chlorine content exceeding 0.20wt%)
- Do not use water-soluble flux.

- Reflow Soldering profile

① Soldering profile for Lead-free solder (Sn-3.0Ag-0.5Cu)

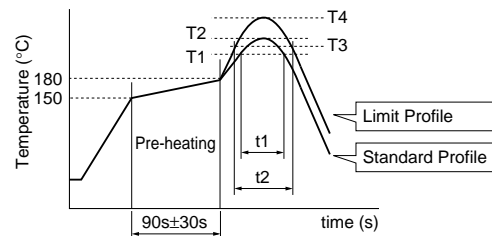

Series	Standard Profile				Limit Profile			
	Heating		Peak temperature (T2)	Cycle of reflow	Heating		Peak temperature (T4)	Cycle of reflow
	Temp. (T1)	Time. (t1)			Temp. (T3)	Time. (t2)		
BLM, NFE, NFM, DLW31S	220°C min.	30 to 60s	245 ±3°C	2 times max.	230°C min.	60s max.	260°C /10s	2 times max.
DLW43S					240°C min.	30s max.	260°C	

② Soldering profile for Eutectic solder (Limit profile: refer to ①)

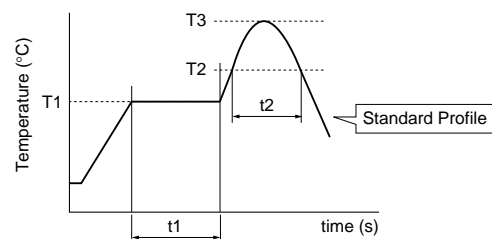

Series	Pre-heating		Standard Profile			
	Heating		Peak temperature (T3)	Cycle of reflow		
	Temp. (T1)	Time. (t1)			Temp. (T2)	Time. (t2)
BLM, NFE, NFM, DLW	150°C	60s min.	183°C min.	60s max.	230°C	2 times max.

Continued on the following page. ☐

Chip EMIFIL® (Soldering and Mounting)

☐ Continued from the preceding page.

(3) Reworking with Soldering Iron

The following conditions must be strictly followed when using a soldering iron.

Pre-heating: 150°C 60s min.

Soldering iron power output: 30W max.

Temperature of soldering iron tip / Soldering time:

BLM/NFM21H/DLW31S/DLW43S
 — 350°C max./3s max. (2 Times max.)

Do not allow the tip of the soldering iron to directly contact the chip.

For additional methods of reworking with a soldering iron, please contact Murata engineering.

4. Mounting on-board with Conductive Glue of BLM18AG_WH1

Please adhere rigidly to the condition below which shows the method of mounting with conductive glue.

Please coat print pads with conductive glue using metal mask and metal squeegee, and then mount our products on the substrates with a mount machine or human hand.

Please put the substrates into a oven (140 to 150°C) for 30 minutes in order to cure the adhesive.

Please check whether the chips and the substrates are connected with the conductive glue or not and there is no electrical short of the conductive glue.

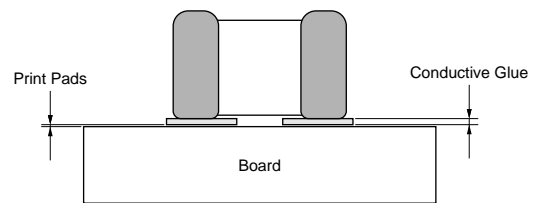

1. Board	Ceramic Board or Alumina Board
2. Thickness of Glue	30 to 50µm
3. Recommended Conductive Glue	PC3000 (Manufactured by Heraeus)

5. Cleaning

Following conditions should be observed when cleaning chip EMI filter.

(1) Cleaning Temperature: 60°C max. (40°C max. for alcohol type cleaner)

(2) Ultrasonic

Output: 20W/liter max.

Duration: 5 minutes max.

Frequency: 28 to 40kHz

(3) Cleaning agent

The following list of cleaning agents have been tested on the individual components. Evaluation of final assembly should be completed prior to production.

Do not clean BLM18AG□□□WH1/DLW31S/43S series. Before cleaning, please contact Murata engineering.

(a) Alcohol cleaning agent

Isopropyl alcohol (IPA)

(b) Aqueous cleaning agent

Pine Alpha ST-100S

(4) Ensure that flux residue is completely removed.

Component should be thoroughly dried after aqueous agent has been removed with deionized water.

For additional cleaning methods, please contact Murata engineering.

Block Type EMIFIL[®] SMD Type (Soldering and Mounting)

1. Standard Land Pattern Dimensions

-  Land Pattern + Solder Resist
 -  Land Pattern
 -  Through Hole
- (in mm)

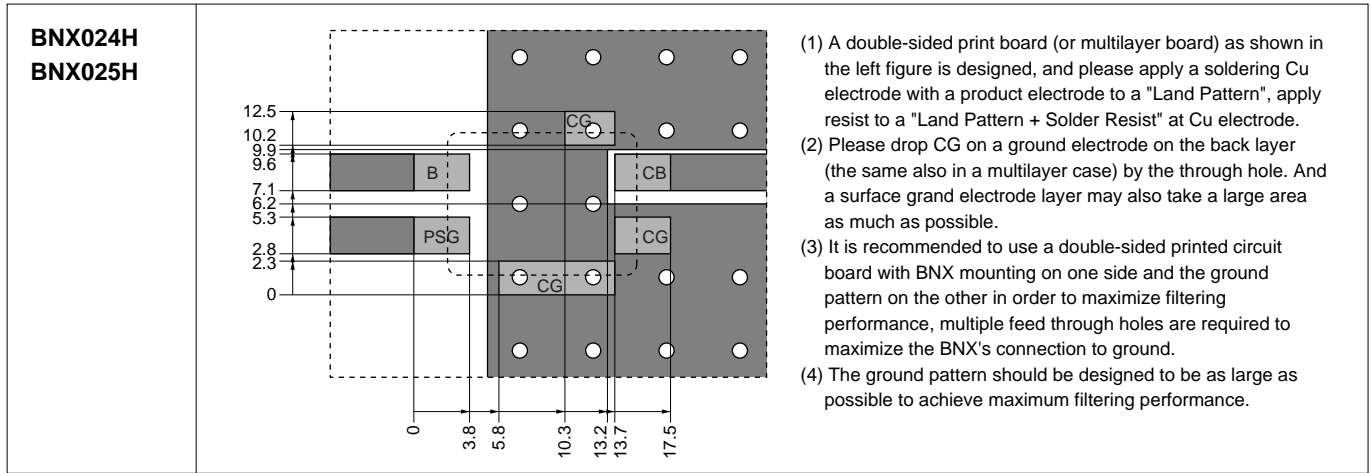

2. Solder Paste Printing and Adhesive Application

(in mm)

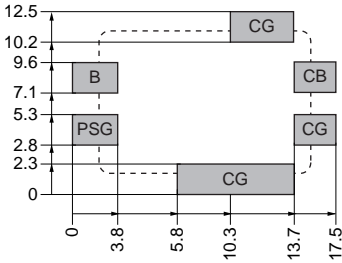
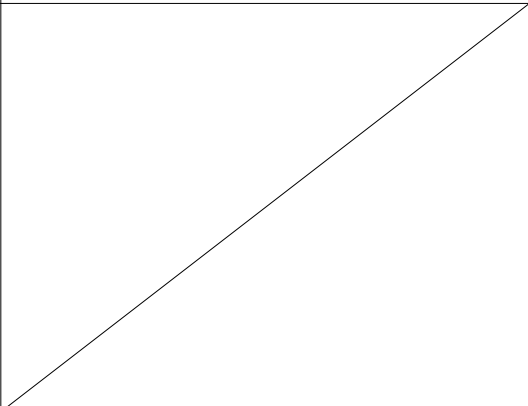
Series	Solder Paste Printing	Adhesive Application
BNX024H BNX025H	<ul style="list-style-type: none"> ● Use Sn-3.0Ag-0.5Cu pattern printing solder. ● Coat with solder paste to the following thickness: 150-200μm <div style="text-align: center; margin-top: 10px;">  </div>	

3. Standard Soldering Conditions

(1) Soldering Methods

BNX024H/025H is only for reflow soldering.

Solder: Use Sn-3.0Ag-0.5Cu solder.

Flux:

- Use Rosin-based flux.
- Do not use strong acidic flux (with chlorine content exceeding 0.20wt%)
- Do not use water-soluble flux.

For additional mounting methods, please contact Murata.

Continued on the following page. 

Block Type EMIFIL[®] SMD Type (Soldering and Mounting)

☐ Continued from the preceding page.

(2) Soldering profile

● Reflow Soldering profile

① Soldering profile for Lead-free solder (Sn-3.0Ag-0.5Cu)

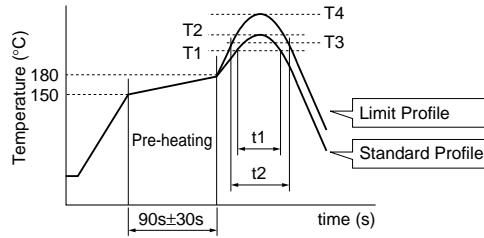

Series	Standard Profile				Limit Profile			
	Heating		Peak temperature (T2)	Cycle of reflow	Heating		Peak temperature (T4)	Cycle of reflow
	Temp. (T1)	Time. (t1)			Temp. (T3)	Time. (t2)		
BNX024H/025H	220°C min.	30 to 60s	250±3°C	2 times max.	230°C min.	60s max.	260°C/10s	2 times max.

(3) Reworking with Solder Iron

The following conditions must be strictly followed when using a soldering iron.

Pre-heating: 150°C 60s min.

Soldering iron power output: 100W max.

Temperature of soldering iron tip / Soldering time:

BNX024H/025H: 450°C max./5s max.

Do not allow the tip of the soldering iron to directly contact the chip.

For additional methods of reworking with a soldering iron, please contact Murata engineering.

4. Cleaning

Do not clean BNX024H/025H.

Before cleaning, please contact Murata engineering.

Block Type EMIFIL[®] Lead Type (Soldering and Mounting)

1. Mounting Hole

Mounting holes should be designed as specified below.

Part Number	Bulk Type (in mm)
BNX012H	<p>Component Side</p> <p>TERMINAL LAYOUT (Bottom figure)</p>

2. Using The Block Type EMIFIL[®] Effectively

(1) How to use effectively

This product effectively prevents undesired radiation and external noise from going out / entering the circuit by grounding the high frequency components which cause noise problems. Therefore, grounding conditions may affect the performance of the filter and attention should be paid to the following for effective use.

- Design maximized grounding area in the P.C. board, and grounding pattern for all the grounding terminals of the product to be connected. (Please follow the specified recommendations.)
- Minimize the distance between ground of the P.C. board and the ground plate of the product. (Recommended to use through-hole connection between grounding area both of component side and bottom side.)
- Insert the terminals into the holes on P.C. board completely.
- Don't connect PSG terminal with CG terminal directly. (See the item 1. TERMINAL LAYOUT)

(2) Self-heating

Though this product has a large rated current, localized self-heating may be caused depending on soldering conditions.

To avoid this, attention should be paid to the following:

- Use P.C. board with our recommendation on hole diameter / land pattern dimensions, mentioned in the right hand drawing, especially for 4 terminals which pass current.
- Solder the terminals to the P.C. board with solder-cover area at least 90%. Otherwise, excess self-heating at connection between terminals and P.C. board may lead to smoke and / or fire of the product even when operating at rated current.
- After installing this product in your product, please make sure of the self-heating with the rated current.

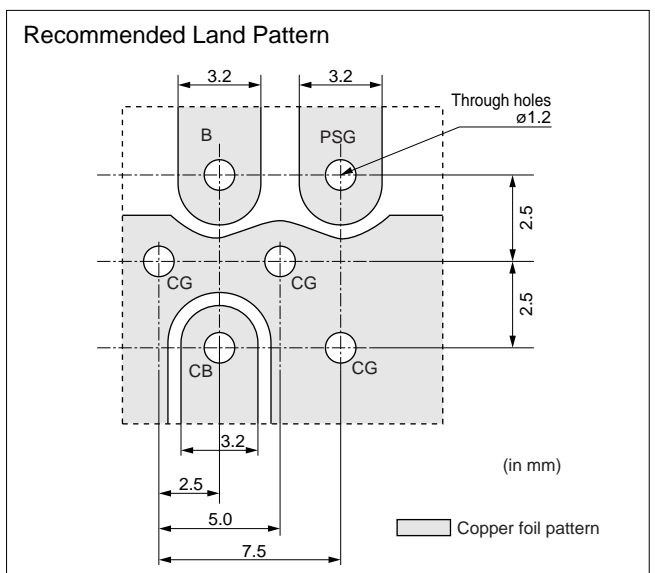
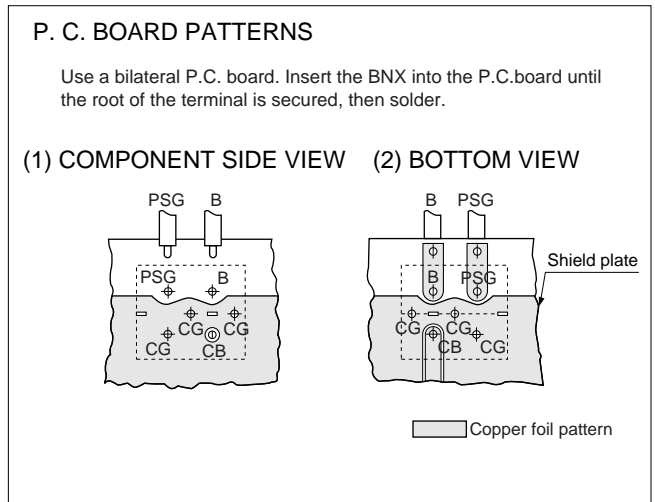

Continued on the following page. ↗

Block Type EMIFIL[®] Lead Type (Soldering and Mounting)

☐ Continued from the preceding page.

3. Soldering

- (1) Solder: H60A, H63A solder (JIS Z 3238)
 In case of lead-free solder, use Sn-3.0Ag-0.5Cu solder.
- (2) Use Rosin-based flux. Do not use strong acidic flux with halide content exceeding 0.2wt% (chlorine conversion value).
- (3) Products and the leads should not be subjected to any mechanical stress during the soldering process, or while subjected to the equivalent high temperatures.
- (4) Standard flow soldering profile

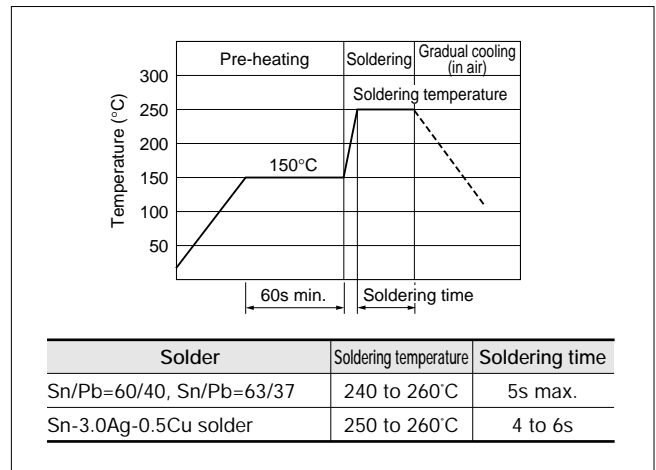

4. Cleaning Conditions

Following conditions should be observed when cleaning BNX012H series.

- (1) Cleaning temperature should be limited to 60°C max. (40°C max for alcohol type cleaner.)
- (2) Ultrasonic cleaning should comply with the following conditions, avoiding the resonance phenomenon at the mounted products and P.C.B.
 Power: 20 W / l max. Frequency: 28 to 40kHz
 Time: 5 min. max.
- (3) Cleaner
 - (a) Alcohol type cleaner
 Isopropyl alcohol (IPA)
 - (b) Aqueous agent
 PINE ALPHA ST-100S
- (4) There should be no residual flux or residual cleaner left after cleaning.
 In the case of using aqueous agent, products should be dried completely after rinsing with de-ionized water in order to remove the cleaner.
- (5) The surface of products may become dirty after cleaning, but there is no deterioration on mechanical, electrical characteristics and reliability.
- (6) Other cleaning: Please contact us.

Package

■ Minimum Quantity and Dimensions of 8mm Width Paper / Embossed Tape

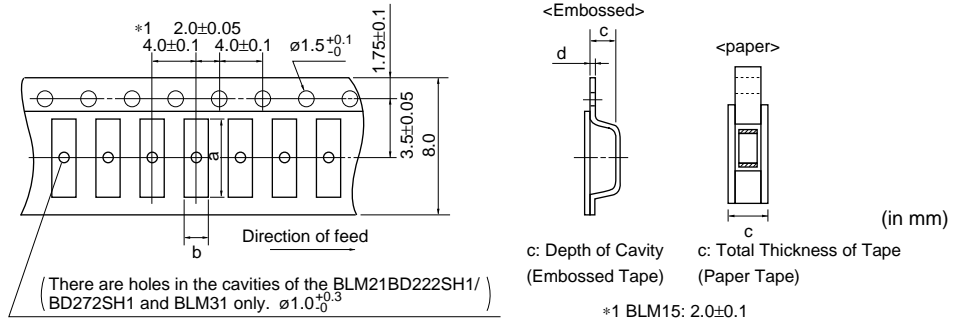

Part Number	Cavity Size (in mm)				Minimum Qty. (pcs.)				Bulk
	a	b	c	d	ø180mm reel		ø330mm reel		
					Paper Tape	Embossed Tape	Paper Tape	Embossed Tape	
BLM15	1.15	0.65	0.8 max.	-	10000	-	50000	-	1000
BLM18	1.85	1.05	1.1 max.	-	4000	-	10000	-	1000
BLM21	2.25	1.45	1.1 max.	-	4000	-	10000	-	1000
BLM21BD222SH1/272SH1	2.25	1.45	1.3	0.2	-	3000	-	10000	1000
BLM31	3.5	1.9	1.3	0.2	-	3000	-	10000	1000
NFM21	2.3	1.55	1.1 max.	-	4000	-	-	-	500
DLW31S	3.6	2.0	2.1	0.3	-	2000	-	-	500

• Please contact us for BLM15/18 in bulk case.

■ Minimum Quantity and Dimensions of 12mm Width Embossed Tape

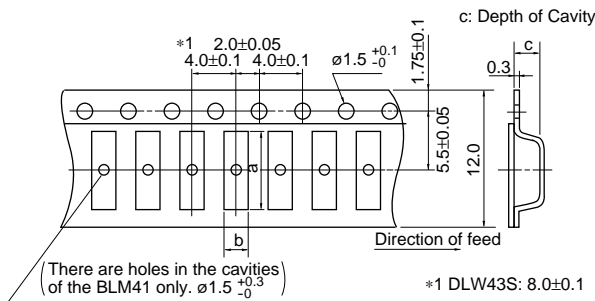

Part Number	Cavity Size			Minimum Qty. (pcs.)		
	a	b	c	ø180mm reel	ø330mm reel	Bulk
BLM41	4.8	1.9	1.75	2500	8000	1000
NFE61	7.2	1.9	1.75	2500	8000	500
DLW43S_XK	4.9	3.6	2.7	500	2500	100
DLW43S_XP	4.9	3.6	2.9	500	2500	100

Package

■ Minimum Quantity and Dimensions of 24mm Width Embossed Tape

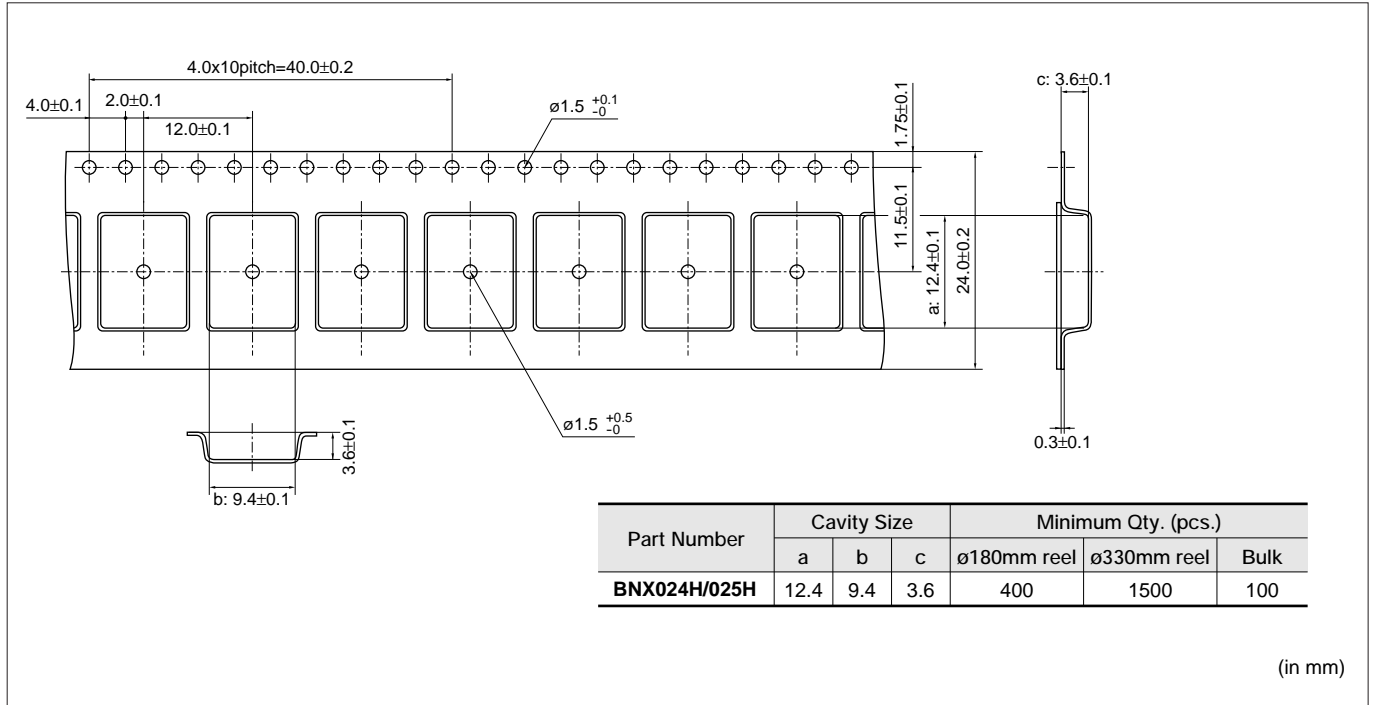

Design Kits



●EKEMAT15B (Chip Ferrite Beads 0402 Size for Automotive)

No.	Part Number	Quantity (pcs.)	Impedance typ. (at 100MHz, 20°C) (Ω)	Rated Current (mA)	DC Resistance (Ω) max.
1	BLM15AG100SH1	10	10 (Typ.)	1000	0.05
2	BLM15AG700SH1	10	70 (Typ.)	500	0.15
3	BLM15AG121SH1	10	120 ±25%	500	0.25
4	BLM15AG221SH1	10	220 ±25%	300	0.35
5	BLM15AG601SH1	10	600 ±25%	300	0.6
6	BLM15AG102SH1	10	1000 ±25%	200	1.0
7	BLM15BB050SH1	10	5 ±25%	500	0.08
8	BLM15BB100SH1	10	10 ±25%	300	0.1
9	BLM15BB220SH1	10	22 ±25%	300	0.2
10	BLM15BB470SH1	10	47 ±25%	300	0.35
11	BLM15BB750SH1	10	75 ±25%	300	0.4
12	BLM15BB121SH1	10	120 ±25%	300	0.55
13	BLM15BB221SH1	10	220 ±25%	200	0.8
14	BLM15BD471SH1	10	470 ±25%	200	0.6
15	BLM15BD601SH1	10	600 ±25%	200	0.65
16	BLM15BD102SH1	10	1000 ±25%	200	0.9
17	BLM15BD182SH1	10	1800 ±25%	200	1.4

●EKEMAT18C (Chip Ferrite Beads 0603 Size for Automotive)

No.	Part Number	Quantity (pcs.)	Impedance typ. (at 100MHz, 20°C) (Ω)	Impedance typ. (at 1GHz, 20°C) (Ω)	Rated Current (mA)	DC Resistance (Ω) max.
1	BLM18AG121SH1	10	120 ±25%	-	500	0.18
2	BLM18AG151SH1	10	150 ±25%	-	500	0.25
3	BLM18AG221SH1	10	220 ±25%	-	500	0.25
4	BLM18AG331SH1	10	330 ±25%	-	500	0.30
5	BLM18AG471SH1	10	470 ±25%	-	500	0.35
6	BLM18AG601SH1	10	600 ±25%	-	500	0.38
7	BLM18AG102SH1	10	1000 ±25%	-	400	0.50
8	BLM18BA050SH1	10	5 ±25%	-	500	0.2
9	BLM18BA100SH1	10	10 ±25%	-	500	0.25
10	BLM18BA220SH1	10	22 ±25%	-	500	0.35
11	BLM18BA470SH1	10	47 ±25%	-	300	0.55
12	BLM18BA750SH1	10	75 ±25%	-	300	0.7
13	BLM18BA121SH1	10	120 ±25%	-	200	0.9
14	BLM18BB050SH1	10	5 ±25%	-	700	0.05
15	BLM18BB100SH1	10	10 ±25%	-	700	0.10
16	BLM18BB220SH1	10	22 ±25%	-	600	0.20
17	BLM18BB470SH1	10	47 ±25%	-	550	0.25
18	BLM18BB600SH1	10	60 ±25%	-	550	0.25
19	BLM18BB750SH1	10	75 ±25%	-	500	0.30

Continued on the following page.

Design Kits

Continued from the preceding page.

No.	Part Number	Quantity (pcs.)	Impedance typ. (at 100MHz, 20°C) (Ω)	Impedance typ. (at 1GHz, 20°C) (Ω)	Rated Current (mA)	DC Resistance (Ω) max.
20	BLM18BB121SH1	10	120 ±25%	-	500	0.30
21	BLM18BB141SH1	10	140 ±25%	-	450	0.35
22	BLM18BB151SH1	10	150 ±25%	-	450	0.37
23	BLM18BB221SH1	10	220 ±25%	-	450	0.45
24	BLM18BB331SH1	10	330 ±25%	-	400	0.58
25	BLM18BB471SH1	10	470 ±25%	-	300	0.85
26	BLM18BD470SH1	10	47 ±25%	-	500	0.30
27	BLM18BD121SH1	10	120 ±25%	-	200	0.4
28	BLM18BD151SH1	10	150 ±25%	-	200	0.4
29	BLM18BD221SH1	10	220 ±25%	-	200	0.45
30	BLM18BD331SH1	10	330 ±25%	-	200	0.5
31	BLM18BD421SH1	10	420 ±25%	-	200	0.55
32	BLM18BD471SH1	10	470 ±25%	-	200	0.55
33	BLM18BD601SH1	10	600 ±25%	-	200	0.65
34	BLM18BD102SH1	10	1000 ±25%	-	100	0.85
35	BLM18BD152SH1	10	1500 ±25%	-	50	1.2
36	BLM18BD182SH1	10	1800 ±25%	-	50	1.5
37	BLM18BD222SH1	10	2200 ±25%	-	50	1.5
38	BLM18BD252SH1	10	2500 ±25%	-	50	1.5
39	BLM18HG471SH1	10	470 ±25%	600 (Typ.)	200	0.85
40	BLM18HG601SH1	10	600 ±25%	700 (Typ.)	200	1.0
41	BLM18HG102SH1	10	1000 ±25%	1000 (Typ.)	100	1.6
42	BLM18HD471SH1	10	470 ±25%	1000 (Typ.)	100	1.2
43	BLM18HD601SH1	10	600 ±25%	1200 (Typ.)	100	1.5
44	BLM18HD102SH1	10	1000 ±25%	1700 (Typ.)	50	1.8
45	BLM18EG101TH1	10	100 ±25%	140 (Typ.)	2000	0.04
46	BLM18EG121SH1	10	120 ±25%	145 (Typ.)	2000	0.04
47	BLM18EG181SH1	10	180 ±25%	260 (Typ.)	2000	0.05
48	BLM18EG221TH1	10	220 ±25%	300 (Typ.)	1000	0.15
49	BLM18EG331TH1	10	330 ±25%	450 (Typ.)	500	0.21
50	BLM18EG391TH1	10	390 ±25%	520 (Typ.)	500	0.30
51	BLM18EG471SH1	10	470 ±25%	550 (Typ.)	500	0.21
52	BLM18EG601SH1	10	600 ±25%	700 (Typ.)	500	0.35

●EKEMAT21A (Chip Ferrite Beads 0805 / 1206 Size for Automotive)

No.	Part Number	Quantity (pcs.)	Impedance typ. (at 100MHz, 20°C) (Ω)	Rated Current (mA)	DC Resistance (Ω) max.
1	BLM21AG121SH1	10	120 ±25%	200	0.15
2	BLM21AG151SH1	10	150 ±25%	200	0.15
3	BLM21AG221SH1	10	220 ±25%	200	0.2
4	BLM21AG331SH1	10	330 ±25%	200	0.25
5	BLM21AG471SH1	10	470 ±25%	200	0.25
6	BLM21AG601SH1	10	600 ±25%	200	0.3
7	BLM21AG102SH1	10	1000 ±25%	200	0.45
8	BLM31AJ601SH1	10	600 ±25%	200	0.9
9	BLM21BB050SH1	10	5 ±25%	500	0.07
10	BLM21BB600SH1	10	60 ±25%	200	0.2
11	BLM21BB750SH1	10	75 ±25%	200	0.25
12	BLM21BB121SH1	10	120 ±25%	200	0.25
13	BLM21BB151SH1	10	150 ±25%	200	0.25
14	BLM21BB201SH1	10	200 ±25%	200	0.35
15	BLM21BB221SH1	10	220 ±25%	200	0.35

Continued on the following page. ↗

Design Kits

Continued from the preceding page.

No.	Part Number	Quantity (pcs.)	Impedance typ. (at 100MHz, 20°C) (Ω)	Rated Current (mA)	DC Resistance (Ω) max.
16	BLM21BB331SH1	10	330 ±25%	200	0.4
17	BLM21BB471SH1	10	470 ±25%	200	0.45
18	BLM21BD121SH1	10	120 ±25%	200	0.25
19	BLM21BD151SH1	10	150 ±25%	200	0.25
20	BLM21BD221SH1	10	220 ±25%	200	0.25
21	BLM21BD331SH1	10	330 ±25%	200	0.3
22	BLM21BD421SH1	10	420 ±25%	200	0.3
23	BLM21BD471SH1	10	470 ±25%	200	0.35
24	BLM21BD601SH1	10	600 ±25%	200	0.35
25	BLM21BD751SH1	10	750 ±25%	200	0.4
26	BLM21BD102SH1	10	1000 ±25%	200	0.4
27	BLM21BD152SH1	10	1500 ±25%	200	0.45
28	BLM21BD182SH1	10	1800 ±25%	200	0.5
29	BLM21BD222TH1	10	2200 ±25%	200	0.6
30	BLM21BD222SH1	10	2250 (Typ.)	200	0.6
31	BLM21BD272SH1	10	2700 ±25%	200	0.8

●EKEMATPWA (Chip EMIFIL[®] for Automotive / for Power Supplies)

No.	Part Number	Quantity (pcs.)	Impedance typ. (at 100MHz, 20°C) (Ω)	Rated Current (mA)	DC Resistance (Ω) max.
1	BLM18PG300SH1	10	30 (Typ.)	1000	0.05
2	BLM18PG330SH1	10	33 ±25%	3000	0.025
3	BLM18PG600SH1	10	60 (Typ.)	500	0.10
4	BLM18PG121SH1	10	120 ±25%	2000	0.05
5	BLM18PG181SH1	10	180 ±25%	1500	0.09
6	BLM18PG221SH1	10	220 ±25%	1400	0.1
7	BLM18PG331SH1	10	330 ±25%	1200	0.15
8	BLM18PG471SH1	10	470 ±25%	1000	0.2
9	BLM21PG220SH1	10	22 ±25%	6000	0.01
10	BLM21PG300SH1	10	30 (Typ.)	3000	0.015
11	BLM21PG600SH1	10	60 ±25%	3000	0.025
12	BLM21PG221SH1	10	220 ±25%	2000	0.050
13	BLM21PG331SH1	10	330 ±25%	1500	0.09
14	BLM31PG330SH1	10	33 ±25%	6000	0.01
15	BLM31PG500SH1	10	50 (Typ.)	3000	0.025
16	BLM31PG121SH1	10	120 ±25%	3000	0.025
17	BLM31PG391SH1	10	390 ±25%	2000	0.05
18	BLM31PG601SH1	10	600 ±25%	1500	0.09
19	BLM41PG600SH1	10	60 (Typ.)	6000	0.01
20	BLM41PG750SH1	10	75 (Typ.)	3000	0.025
21	BLM41PG181SH1	10	180 ±25%	3000	0.025
22	BLM41PG471SH1	10	470 ±25%	2000	0.05
23	BLM41PG102SH1	10	1000 ±25%	1500	0.09

No.	Part Number	Quantity (pcs.)	Capacitance (pF)	Rated Voltage (Vdc)	Rated Current (mA)	Insulation Resistance (MΩ) min.
24	NFM21HC220U1H3	10	22 ±20%	50	700	1000
25	NFM21HC470U1H3	10	47 ±20%	50	700	1000
26	NFM21HC101U1H3	10	100 ±20%	50	700	1000
27	NFM21HC221R1H3	10	220 ±20%	50	700	1000
28	NFM21HC471R1H3	10	470 ±20%	50	1000	1000
29	NFM21HC102R1H3	10	1000 ±20%	50	1000	1000

Continued on the following page. ↗

Design Kits

☐ Continued from the preceding page.

No.	Part Number	Quantity (pcs.)	Capacitance (pF)	Rated Voltage (Vdc)	Rated Current (mA)	Insulation Resistance (MΩ) min.
30	NFM21HC222R1H3	10	2200 ±20%	50	1000	1000
31	NFM21HC223R1H3	10	22000 ±20%	50	2000	1000
32	NFM21HC104R1A3	10	100000 ±20%	10	2000	1000
33	NFM21HC224R1A3	10	220000 ±20%	10	2000	1000
34	NFM21HC474R1A3	10	470000 ±20%	10	2000	1000
35	NFE61HT330U2A9	10	33 ±30%	100	2000	1000
36	NFE61HT680R2A9	10	68 ±30%	100	2000	1000
37	NFE61HT101Z2A9	10	100 ±30%	100	2000	1000
38	NFE61HT181C2A9	10	180 ±30%	100	2000	1000
39	NFE61HT361C2A9	10	360 ±20%	100	2000	1000
40	NFE61HT681D2A9	10	680 ±30%	100	2000	1000
41	NFE61HT102F2A9	10	1000 +80%, -20%	100	2000	1000
42	NFE61HT332Z2A9	10	3300 +80%, -20%	100	2000	1000

Outlines of Major Noise Regulation Standards

1. EMI Regulations

Equipment		Countries	Information Regulation	Japan	USA	Europe
Emission	Generic Standard		CISPR61000-6-3 (Residential, Commercial and Light Industry) IEC61000-6-4 (Industrial)			EN50081-1 (Residential, Commercial and Light Industry) EN50081-2 (Industrial)
	ITE : Information Technology Equipment Printer, Personal computer Word processor, Display		CISPR 22	VCCI *1	FCC Part 15 Subpart B	EN55022
	ISM equipment, Microwave		CISPR 11	*1	FCC Part 18	EN55011
	Igniter (Automobile, Motorboat)		CISPR 12	JASO	FCC Part 15 Subpart B	Automotive Directive
	TV, Radio, Audio, VTR		CISPR 13	*1	FCC Part 15 Subpart B	EN55013
	Household electrical equipment Portable tool		CISPR 14	*1		EN55014
	Fluorescent Lamp, Luminary		CISPR 15	*1	FCC Part 18	EN55015
	Transceiver		ITU-T	Radio Act ARIB (Voluntary Regulation)	FCC Part 15 Subpart C FCC Part 22	ETS300 Series
	(Reference) Power Supply Higher Harmonic		IEC61000-3	Industrial Voluntary Regulation		EN61000-3
Immunity	Basic Standard		IEC61000-4	JIS C 61000-4		EN61000-4 Series
	Generic Standard		IEC61000-6-1 (Residential, Commercial and Light Industry) IEC61000-6-2 (Industrial)	JIS C 61000-6-1 (Residential, Commercial and Light Industry) JIS C 61000-6-2 (Industrial)		EN50082-1 (Residential, Commercial and Light Industry) EN50082-2 (Industrial)
	Industrial Process Measurement and Control Equipment			Industrial Voluntary Action		
	Radio, TV		CISPR 20			EN55020
	ITE : Information Technology Equipment		CISPR 24			EN55024

*1 Electrical Appliance and Material Safety Law

There are EMI regulations in each country to meet EMI noise levels emitted from digital equipment. In the countries which regulate EMI, equipment which does not satisfy regulations is not allowed to be sold.

Continued on the following page. 

Outlines of Major Noise Regulation Standards

☐ Continued from the preceding page.

2. Measurement Point and Noise Detection

Regulation	Measuring Item	Polarization and Measuring Point	Frequency (Hz)	Detection	Measuring Devices
CISPR 22/ EN55022	Radiated Interference	Horizontal Pol. Vertical Pol.	30M to 1GHz	Quasi-Peak Detection	Antenna
	Main Interference Voltage	AC Main Ports	150k to 30MHz	Quasi-Peak Detection Mean Detection	Artificial Main Network
VCCI	Radiated Interference	Horizontal Pol. Vertical Pol.	30M to 1GHz	Quasi-Peak Detection	Dipole Antenna
	Main Interference Voltage	AC Main Ports	150k to 30MHz	Quasi-Peak Detection Mean Detection	Artificial Main Network
FCC Part 15	Radiated Interference	Horizontal Pol. Vertical Pol.	30M to 40GHz	Quasi-Peak Detection Mean Detection	Antenna
	Main Interference Voltage	AC Main Ports	150k to 30MHz	Quasi-Peak Detection	Artificial Main Network

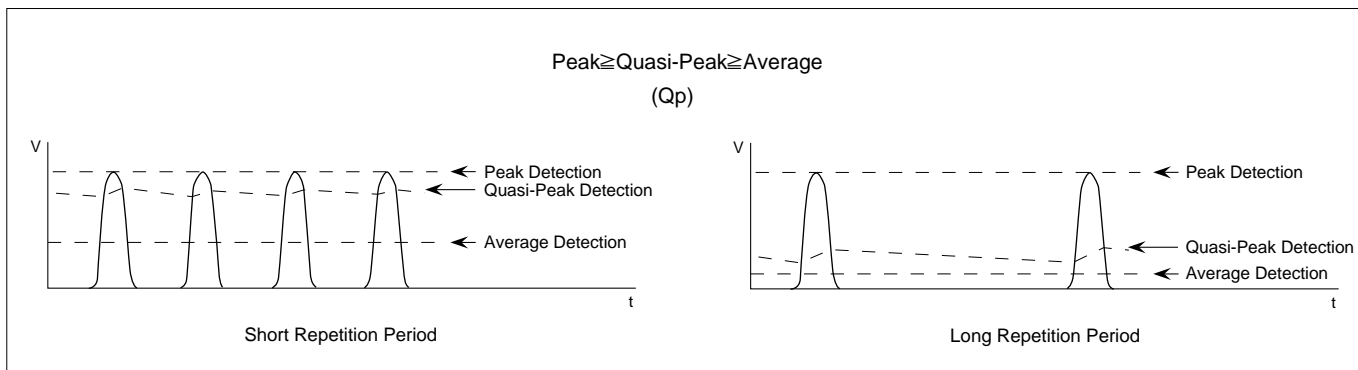

3. Limits of CISPR 22/EN55022

(1) CISPR 22 recommends measurement at 10m distance. However, other distance is acceptable if the limitation is converted according to the following calculation. Limitation shown left is converted to limitation for 3m distance.

Conversion

Limitation for 10m Distance	→	Limitation for 3m Distance
R ₁₀ (dB μ V/m)		R ₃ (dB μ V/m)
r ₁₀ (μ V/m)		r ₃ (μ V/m)
R ₁₀ = 20 log r ₁₀		R ₃ = 20 log r ₃
		R ₃ = R ₁₀ + 20 (1 - log 3)
		$r_3 = \frac{10}{3} r_{10}$

Main Terminal Interference Voltage (Power Supply)

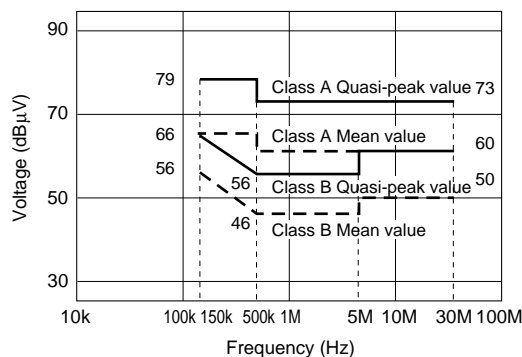

Radiated Interference

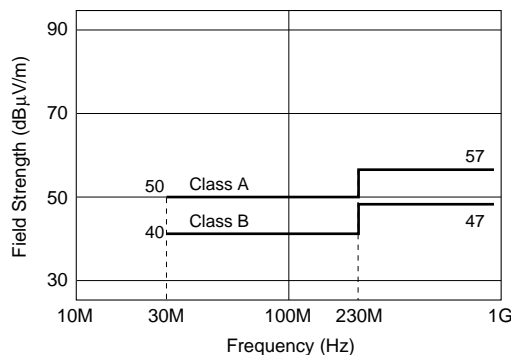

On the border frequency, lower limit should be applied.

Class A Equipment: The equipment which is used in light industrial commercial areas.
 Class B Equipment: The equipment which is used in residential areas.

Continued on the following page. ☐

Outlines of Major Noise Regulation Standards

☐ Continued from the preceding page.

(2) Scope of CISPR 22 Regulation

This regulation applies to information technology equipment (ITE) which are defined as:

- (a) Equipment that receives data from external signal sources;
- (b) Equipment that processes received data;
- (c) Equipment that outputs data; and
- (d) Equipment that has less than 600V rated voltage in power supply.

4. Limits of VCCI Voluntary Regulation

- (1) VCCI recommends measurement at 10m distance; 3m or 30m distance measurements are also allowed.

(2) Scope of VCCI Voluntary Regulation

This regulation applies to information technology equipment (same as CISPR Pub.22), but the application is excluded on the following equipment:

- Equipment for which other regulations already exist (e.g., household electrical appliances, radio and TV receivers)
- In station equipment principal purpose of which is electrical communication
- Industrial plant control system for which information processing is a secondary system function
- Industrial, commercial and medical testing and measuring systems for which data processing is a secondary system function
- Information equipment for which CISPR is conducting further deliberation

VCCI is the acronym of Voluntary Control Council for Interference by Data Processing Equipment and Electronic Office Machines.

VCCI is organized by the following organizations:

- Japan Electronics and Information Technology Industries Association (JEITA)
- Japan Business Machine and Information System Industries Association (JBMIA)
- Communication and Information Network Association of Japan (CIAJ)

CISPR Regulations

- CISPR 10 Organization, Regulations and Procedures of CISPR
- CISPR 11 Industrial, Scientific and Medical (ISM) Radio-Frequency Equipment
- CISPR 12 Vehicles, Motor Boats and Spark-Ignited Engine driven
- CISPR 13 Sound and Television Receivers
- CISPR 14 Household Electrical Appliances, Portable Tools and Similar Electrical Apparatus
- CISPR 15 Fluorescent Lamps and Luminaries
- CISPR 16 Radio Interference Measuring Apparatus and Measurement Methods
- CISPR 17 Passive Radio Interference Filters and Suppression Components
- CISPR 18 Power Transmission Cables and High Voltage equipment
- CISPR 19 Microwave Ovens for Frequencies above 1GHz
- CISPR 20 Immunity of Sound and TV Broadcast Receivers and Associated Equipment
- CISPR 21 Interference to Mobile Radio Communications in the Presence of Impulsive Noise
- CISPR 22 Information Technology Equipment
- CISPR 23 Industrial Scientific and Medical (ISM) Equipment
- CISPR 24 Immunity Regulation of Information Technology Equipment
- CISPR 25 Receiver used onboard vehicles, boats, and on devices

Main Terminal Interference Voltage (Power Supply)

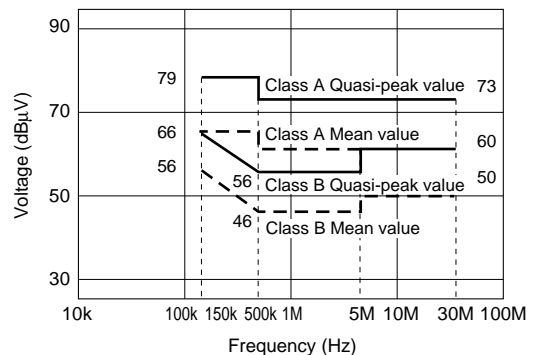

Radiated Interference

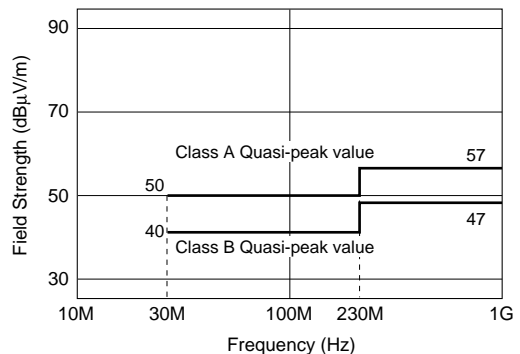

On the border frequency, lower limit should be applied.

Class B ITE: Equipment that is designed to be used at home.
 Class A ITE: Equipment that does not meet interference limits of class B equipment, but satisfies interference limits of class A equipment.

Continued on the following page. ☐

Outlines of Major Noise Regulation Standards

☐ Continued from the preceding page.

5. Limits of FCC Part 15 Subpart B

- (1) Class A recommended to be measured with 10m distance.
 Class B recommended to be measured with 3m distance.
- (2) The FCC Part 15 regulation controls radiated interference by establishing quasi-peak and mean value limits for frequencies ranging from 30MHz to 40GHz (or maximum frequency's fifth harmonic, whichever is lower).
 For AC main ports, the FCC Part 15 regulation controls main terminal interference voltage by establishing quasi-peak value limits for frequencies ranging from 450kHz to 30MHz.

Measurement Frequency Range for Radiated Interference

Maximum Frequency the Equipment Internally Generates, Uses or Operates or Synchronizes (MHz)	Upper End of Measurement Frequency Range (MHz)
Less than 1.705	30
1.705 to 108	1000
108 to 500	2000
500 to 1000	5000
Over 1000	Maximum Frequency's Fifth Harmonic or 40GHz, Whichever is Lower

Main Terminal Interference Voltage (Power Supply)

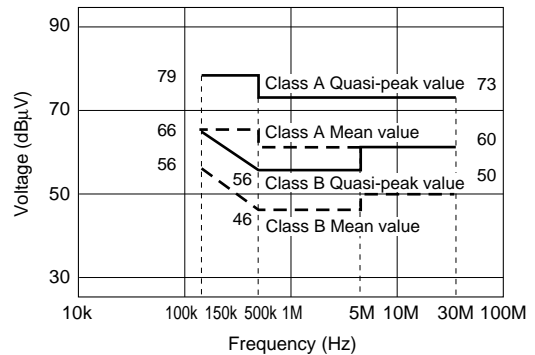

Radiated Interference

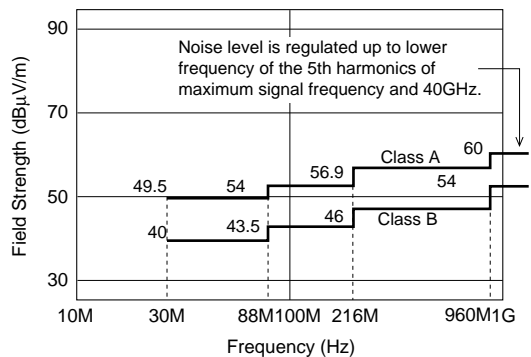

On the border frequency, lower limit should be applied.

Class A Equipment: The digital equipment that is sold for commercial, industrial and office use.

Class B Equipment: The digital equipment that is sold to be used in residential areas.

- (3) There is no regulation on power interference.

FCC Regulations

- Part 1 Procedures
- Part 2 Frequency Division and Radio Wave Treaty Issues and General Rules
- Part 15 Radio Wave Equipment
 - Intentionally electromagnetic radiation equipment
 - Non-intentionally electromagnetic radiation equipment
 - Incidentally electromagnetic radiation equipment
- Part 18 Industrial, Scientific and Medical Equipment
- Part 22 Public Mobile Wireless Operations
- Part 68 Connecting Terminal Equipment to Telephone Circuit Network
- Part 76 Cable Television

Continued on the following page. ☐

Outlines of Major Noise Regulation Standards

☒ Continued from the preceding page.

6. Immunity Regulations in the European Union

All electric/electronic equipment cannot be sold in Europe without CE marking. To use CE marking, they must satisfy related EC directives such as EMC directives. For Information Technology Equipment, in EMC directive, emission regulations are integrated, and immunity regulations are applied. Although these immunity regulations are prepared by CENELEC, almost all contents are same as standards issued by IEC or CISPR.

All products which are sold in EU must satisfy EC directive which contains immunity regulation.

Principal EC Directive	
EMC Directive	89/336/EEC 92/31/EEC
Low-Voltage Electrical Products Directive	73/23/EEC
Machines Directive	89/392/EEC

7. Immunity Regulations in Japan

Equipment	Association
TV, Radio, Audio	JEITA (Japan Electronics and Information Technology)
ITE	
Office Machine	JBMIA (Japan Business Machine and Information System Industries Association)
Mi	CIAJ (Communication and Information Network Association of Japan) ARIB (Association of Radio Industries and Business)
Machine To Builders	JMTBA (Japan Machine Tool Builders' Association)
Industrial Measuring Control Equipment	JEMIMA (Japan Electric Measuring Instruments Manufacturers' Association)
Industrial Robot	JARA (Japan Robot Association)

The table on the right shows the preparation situation of JIS for EMC. At this moment, the immunity standards by JIS do not have a legal force like the Electrical Application and Material Safety Law/VCCI.

Classification	Information Regulation	JIS
Terms	ISO60050-161 (IEV terms 161)	JIS C 0161
Basic Standards	IEC61000-4- 2	JIS C 61000-4-2
	IEC61000-4- 3	JIS C 61000-4-3
	IEC61000-4- 4	JIS C 61000-4-4
	IEC61000-4- 5	JIS C 61000-4-5
	IEC61000-4- 6	JIS C 61000-4-6
	IEC61000-4- 7	JIS C 61000-4-7
	IEC61000-4- 8	JIS C 61000-4-8
	IEC61000-4-11	JIS C 61000-4-11
Generic Standards	IEC61000-4-14	JIS C 61000-4-14
	IEC61000-4-17	JIS C 61000-4-17
	IEC61000-6-1 IEC61000-6-2	JIS C 61000-6-1 JIS C 61000-6-2

Principles of Noise Suppression by DC EMIFIL®

1. Function of DC EMI Suppression Filters

DC EMI suppression filters absorb and eliminate high frequency noise which may produce electromagnetic interference in PC board circuits.

These filters are used in secondary circuits, and are small in size and light in weight, which further enhances their excellent noise suppression functions.

Chip and adhesive type filters can be mounted on PC boards automatically.

These filters are effective in the suppression of radiation noise in computers, peripheral equipment, and digital circuit application equipment (including various types of microcomputer application equipment), and function to suppress noise in audio/visual equipment, which uses digital memory chips and DSP.

These filters are also effective for improving the noise immunity of equipment used in noisy environments (such as electronic equipment for automobiles).

2. Noise Filter Suppression Principles

Generally, noise problems occur when the noise source and electronic equipment sensitive to the influence of noise are located in close proximity to one another.

In such situations, as shown in Figure at right, noise is conducted through a conductor, which produces an inductive field around the noise source.

To overcome such noise problems, it is preferable to reduce the amount of noise generated by the noise source or improve the noise resistance of adjacent equipment.

In order to satisfy equipment performance specifications and eliminate noise effectively at the same time, however, it is customary to reduce the amount of noise generated by the noise source, if it can't be eliminated altogether.

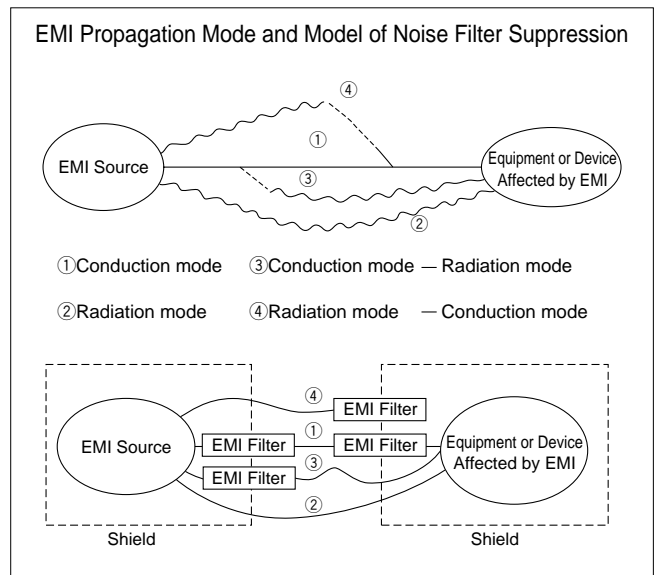

3. Configuration of EMI Suppression Filters (DC)

DC EMI suppression filters are used to suppress noise produced by conductors. Noise radiation can be suppressed, if it is eliminated with a filter in advance.

Generally, such noise suppression is achieved with DC EMI suppression filters, according to the capacitive and inductive frequency characteristics of the respective conductors in the circuit.

Filters of this kind can be roughly divided into those:

- (1) employing a capacitor,
- (2) employing an inductor,
- (3) employing a capacitor and inductor combination.

Continued on the following page.

Principles of Noise Suppression by DC EMIFIL®

☐ Continued from the preceding page.

4. Capacitive Noise Suppression

When a capacitor is connected (bypass capacitor) to ground from a noisy signal line or power line, the circuit impedance decreases as the frequency increases. Since noise is a high frequency phenomenon, it flows to ground if a capacitor has been connected to ground, thereby making it possible to eliminate noise. (See Fig.)

EMI suppression filters employing a capacitor in this way are used to eliminate this type of noise.

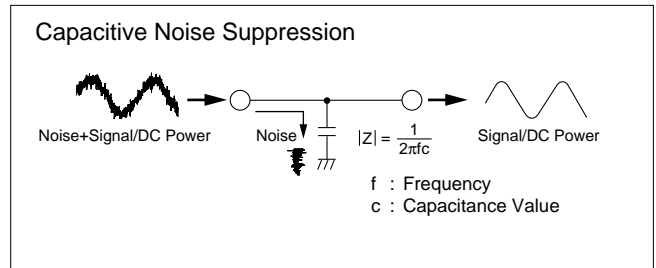

5. High frequency Capacitor Characteristics Used for EMI Suppression Filters

Even general-purpose capacitors can be used for noise suppression. However, since noise has an extremely high frequency range, general-purpose capacitors may not function as effective bypass capacitors, due to the large residual inductance built into the capacitor.

All the capacitors used in Murata's EMI suppression filters employ a three terminal structure or thru-type structure, which functions effectively even at high frequencies, thereby minimizing the influence of residual inductance. Consequently, an effective filter circuit can be formed even at frequencies exceeding 1GHz.

(Refer to Fig.)

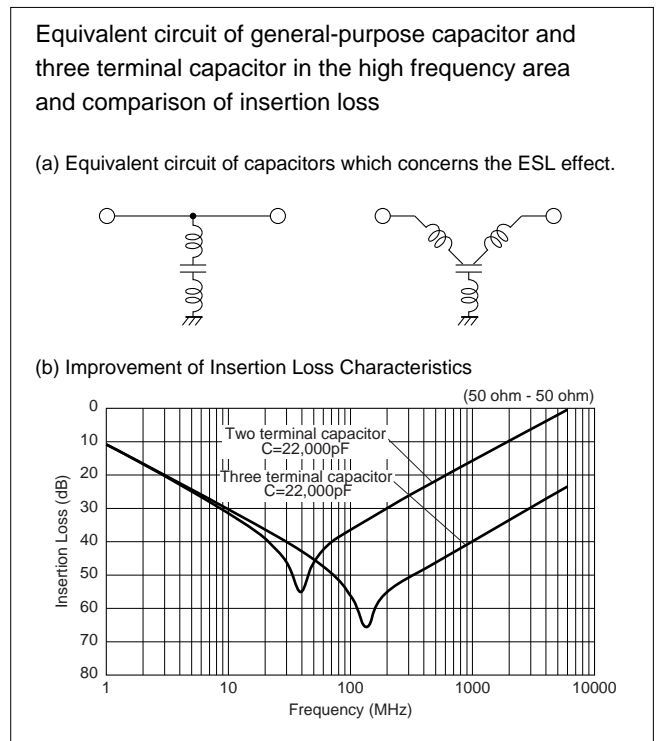

6. Inductive Noise Suppression

When an inductor is inserted in series in a noise producing circuit (See Fig.), its impedance increases with frequency. In this configuration it is possible to attenuate and eliminate noise components (high frequency components). The Murata EMI suppression filter functions in this way.

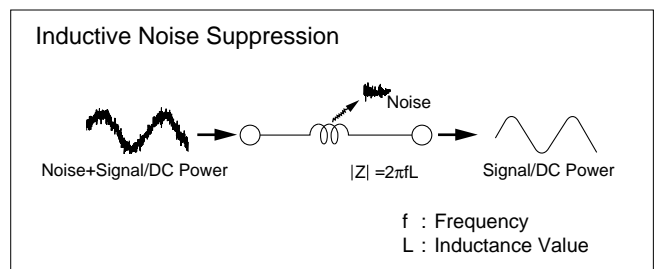

Continued on the following page. ☐

Principles of Noise Suppression by DC EMIFIL®

☐ Continued from the preceding page.

7. Characteristics of Inductors Used in EMI Suppression Filters

General-purpose inductors also function to suppress noise when configured in series with a noise producing circuit. However, when general-purpose inductors are used, resonance may result in peripheral circuits, signal wave forms may become distorted, and satisfactory impedance may not be obtained at noise frequencies (due to insufficient high frequency impedance characteristics).

The inductors used for Murata's EMI suppression filters are designed to function nearly as a resistor at noise frequencies, which greatly reduces the possibility of resonance and leaves signal wave forms undistorted. And since sufficient impedance is obtained for frequencies ranging to hundreds of MHz, these specifically designed inductors operate effectively to suppress high-frequency noise. (See Fig.)

Equivalent Circuit

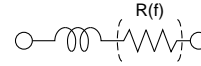

(Resistance element becomes dominant at high frequency.)

Example of impedance frequency characteristics of inductor type EMIFIL®

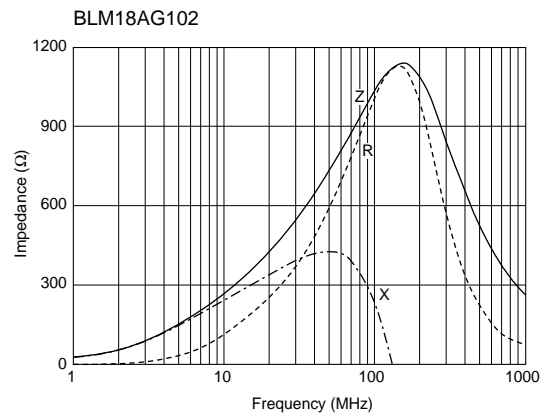

8. Capacitive-Inductive EMI Suppression Filters

If capacitive and inductive suppression characteristics are combined, it is possible to configure a much higher performance filter. In signal circuit applications where this combination is applied, noise suppression effects which have little influence on the signal wave form become possible.

This type of filter is also effective in the suppression of high-speed signal circuit noise. When used in DC power circuits, capacitive-inductive filters prevent resonance from occurring in peripheral circuits, thus making it possible to achieve significant noise suppression under normal service conditions.

9. Other EMI Suppression Filters

In addition to the capacitive-inductive filter, Murata also has a common mode choke coil, effective for common mode noise suppression.

Murata also has a range of built-in filter connectors which greatly reduce filter mounting space requirements.

Continued on the following page. ☐

Principles of Noise Suppression by DC EMIFIL[®]

☒ Continued from the preceding page.

10. Expressing EMI Suppression Filter Effects

EMI Suppression Filter effects are expressed in terms of the insertion loss measured in the circuit, normally specified in MIL-STD 220A. As shown in the 50Ω impedance circuit in the Figure at right, insertion loss is represented by the logarithmic ratio of the circuit output voltage with and without a filter in the circuit, which is multiplied by 20 and expressed in dB.

Therefore, an insertion loss of 20dB indicates an output voltage ratio (B/C) of 1/10, and an insertion loss of 40dB indicates an output voltage ratio (B/C) of 1/100.

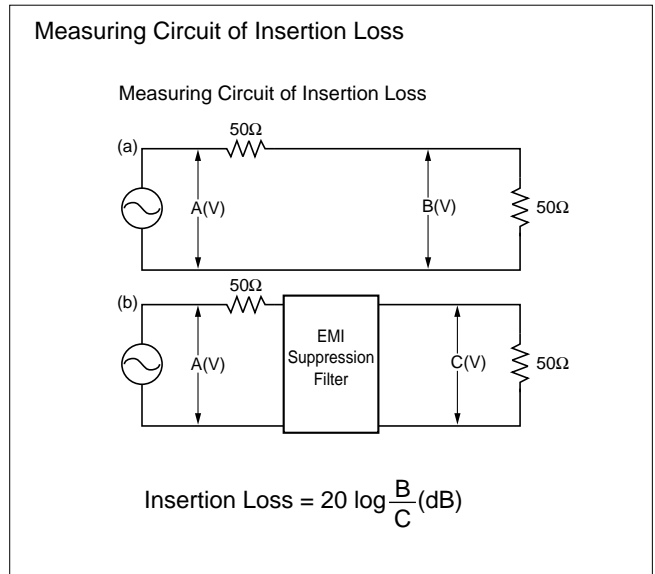

⚠Note:

1. Export Control

<For customers outside Japan>

No Murata products should be used or sold, through any channels, for use in the design, development, production, utilization, maintenance or operation of, or otherwise contribution to (1) any weapons (Weapons of Mass Destruction [nuclear, chemical or biological weapons or missiles] or conventional weapons) or (2) goods or systems specially designed or intended for military end-use or utilization by military end-users.

<For customers in Japan>

For products which are controlled items subject to the "Foreign Exchange and Foreign Trade Law" of Japan, the export license specified by the law is required for export.

2. Please contact our sales representatives or product engineers before using the products in this catalog for the applications listed below, which require especially high reliability for the prevention of defects which might directly damage a third party's life, body or property, or when one of our products is intended for use in applications other than those specified in this catalog.

- | | |
|-----------------------------|--|
| ① Aircraft equipment | ② Aerospace equipment |
| ③ Undersea equipment | ④ Power plant equipment |
| ⑤ Medical equipment | ⑥ Transportation equipment (vehicles, trains, ships, etc.) |
| ⑦ Traffic signal equipment | ⑧ Disaster prevention / crime prevention equipment |
| ⑨ Data-processing equipment | ⑩ Application of similar complexity and/or reliability requirements to the applications listed above |

3. Product specifications in this catalog are as of July 2008. They are subject to change or our products in it may be discontinued without advance notice.

Please check with our sales representatives or product engineers before ordering. If there are any questions, please contact our sales representatives or product engineers.

4. Please read rating and ⚠CAUTION (for storage, operating, rating, soldering, mounting and handling) in this catalog to prevent smoking and/or burning, etc.

5. This catalog has only typical specifications. Therefore, please approve our product specifications or transact the approval sheet for product specifications before ordering.

6. Please note that unless otherwise specified, we shall assume no responsibility whatsoever for any conflict or dispute that may occur in connection with the effect of our and/or a third party's intellectual property rights and other related rights in consideration of your use of our products and/or information described or contained in our catalogs. In this connection, no representation shall be made to the effect that any third parties are authorized to use the rights mentioned above under licenses without our consent.

7. No ozone depleting substances (ODS) under the Montreal Protocol are used in our manufacturing process.

 **Murata Manufacturing Co., Ltd.**

<http://www.murata.com/>

Head Office

1-10-1, Higashi Kotari, Nagaokakyo-shi, Kyoto 617-8555, Japan
Phone: 81-75-951-9111

International Division

3-29-12, Shibuya, Shibuya-ku, Tokyo 150-0002, Japan
Phone: 81-3-5469-6123 Fax: 81-3-5469-6155 E-mail: intl@murata.co.jp