

HYBRID INTEGRATED CIRCUIT VHF/UHF WIDE-BAND AMPLIFIER

Three-stage wide-band amplifier in hybrid integrated circuit technique on a thin-film substrate, intended for use in mast-head booster-amplifiers, as preamplifier in MATV systems, and as general-purpose amplifier for v.h.f. and u.h.f. applications.

QUICK REFERENCE DATA

Frequency range	f	40 to 860 MHz
Source and load (characteristic) impedance	$R_S = R_L = Z_0 =$	75 Ω
Transducer gain	$G_{tr} = s_f ^2$	typ. 23 dB
Flatness of frequency response	$\pm \Delta s_f ^2$	typ. 1.0 dB
Output voltage at -60 dB intermodulation distortion (DIN 45004, 3-tone)	$V_{O(rms)}$	> 105 dB μ V
Noise figure	F	typ. 7 dB
D.C. supply voltage	V_B	= 12 V \pm 10%
Operating ambient temperature	T_{amb}	-20 to +70 $^{\circ}$ C

ENCAPSULATION 8-pin, in-line, resin-coated body, see MECHANICAL DATA (Fig. 2)

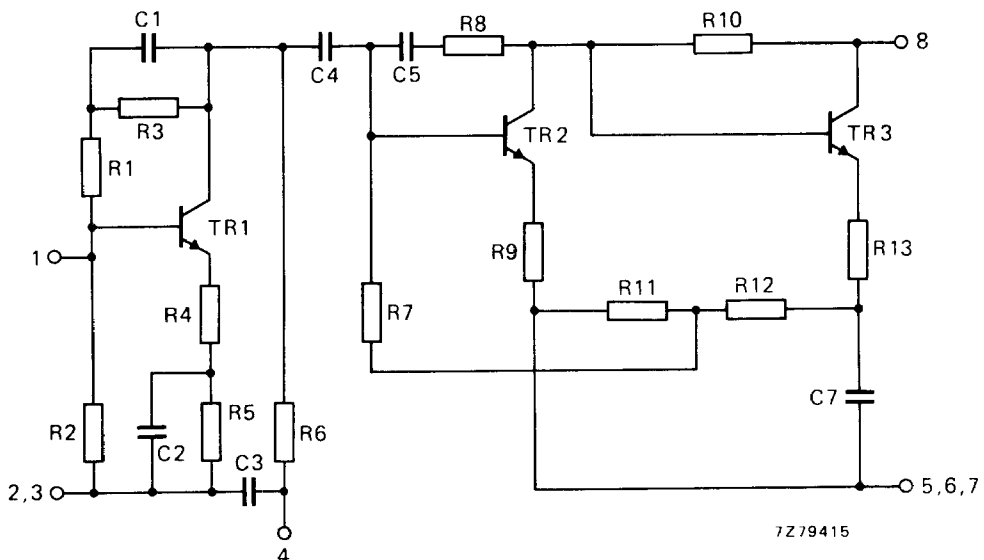

Fig. 1 Circuit diagram.

RATINGS

Limiting values in accordance with the Absolute Maximum System (IEC 134)

Operating ambient temperature	T_{amb}	–20 to +70 °C
Storage temperature	T_{stg}	–40 to +125 °C
D.C. supply voltage	V_B	max. 15 V
Peak incident powers on pins 1 and 7	P_{11M}, P_{17M}	max. 100 mW

CHARACTERISTICS**Measuring conditions**

Ambient temperature	T_{amb}	=	25 °C
D.C. supply voltage	V_B	=	12 V
Source impedance and load impedance	R_s, R_l	=	75 Ω
Characteristic impedance of h.f. connections	Z_o	=	75 Ω
Frequency range	f	=	40 to 860 MHz

Performance

Supply current	I_B	typ.	56 mA
Transducer gain	$G_{tr} = s_f ^2$	typ.	23 dB 21 to 25 dB
Flatness of frequency response	$\pm \Delta s_f ^2$	typ.	1.0 dB
Individual maximum v.s.w.r.			
input	$VSWR_{(i)}$	typ.	1,3 *
output	$VSWR_{(o)}$	typ.	1,5 *
Back attenuation			
$f = 100$ MHz	$ s_r ^2$	typ.	42 dB
$f = 860$ MHz	$ s_r ^2$	typ.	33 dB
Output voltage			
at –60 dB intermodulation distortion (DIN 45004, par. 6.3: 3-tone)	$V_o(rms)$	>	105 dB μ V typ. 107 dB μ V
Noise figure	F	typ.	7 dB

s-parameters:	$s_f = s_{21}$	$s_i = s_{11}$
	$s_r = s_{12}$	$s_o = s_{22}$

* Highest value, for a sample, occurring in the frequency range.

OPERATING CONDITIONS

Ambient temperature range

 T_{amb}

-20 to +70 °C

D.C. supply voltage

 V_B = 12 V \pm 10%

Frequency range

f

40 to 860 MHz

Source impedance and load impedance

 R_s, R_l = 75 Ω **MECHANICAL DATA**

Dimensions in mm

The device is resin coated.

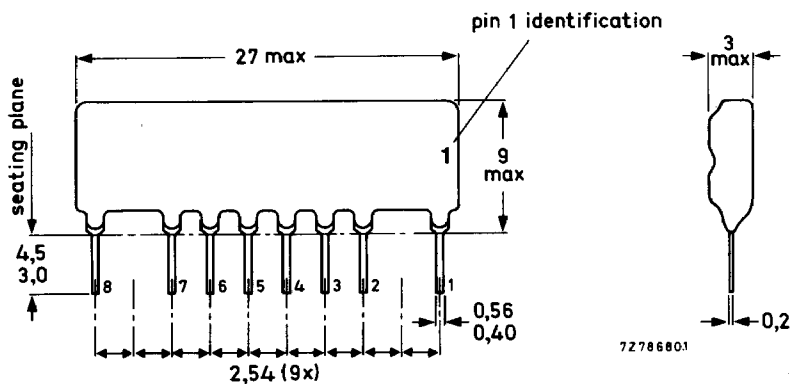

Fig. 2 Encapsulation.

Terminal connections

- 1 = input
- 2, 3, 5, 6, 7 = common
- 4 = supply (+)
- 8 = output/supply (+)

Soldering recommendations*Hand soldering*

Maximum contact time for a soldering-iron temperature of 260 °C up to the seating plane is 5 s.

Dip or wave soldering

260 °C is the maximum permissible temperature of the solder; it must not be in contact with the joint for more than 5 seconds. The total contact time of successive solder waves must not exceed 5 seconds. The device may be mounted against the printed-circuit board, but the temperature of the device must not exceed 125 °C. If the printed-circuit board has been pre-heated, forced cooling may be necessary immediately after soldering to keep the temperature below the allowable limit.

Mounting recommendations

The module should preferably be mounted on double-sided printed-circuit board, see the example shown below.

Input and output should be connected to 75 Ω tracks.

The connections to the 'common' pins should be as close to the seating plane as possible.

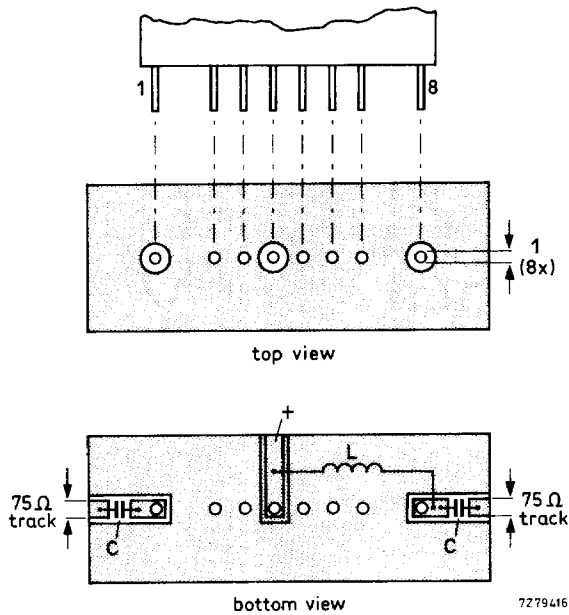

$L > 5 \mu\text{H}$; e.g. catalogue no. 3122 108 20150 or 27 turns enamelled Cu wire (0,3 mm) wound on a ferrite core with a diameter of 1,6 mm.
 $C > 220 \text{ pF}$ ceramic capacitor.

Fig. 3 Printed-circuit board holes and tracks.

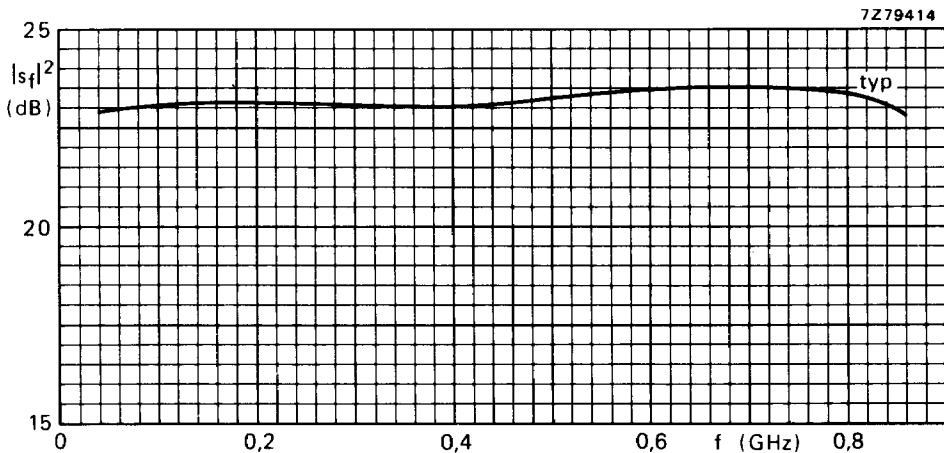

Fig. 4 Transducer gain as a function of frequency; $Z_0 = 75 \Omega$.

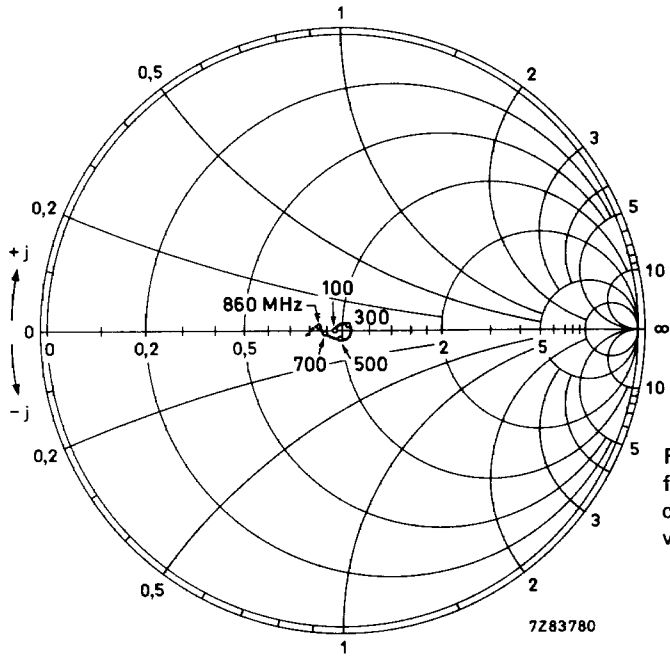

Fig. 5 Input impedance derived from input reflection coefficient s_i , co-ordinates in ohm $\times 75$; typical values.

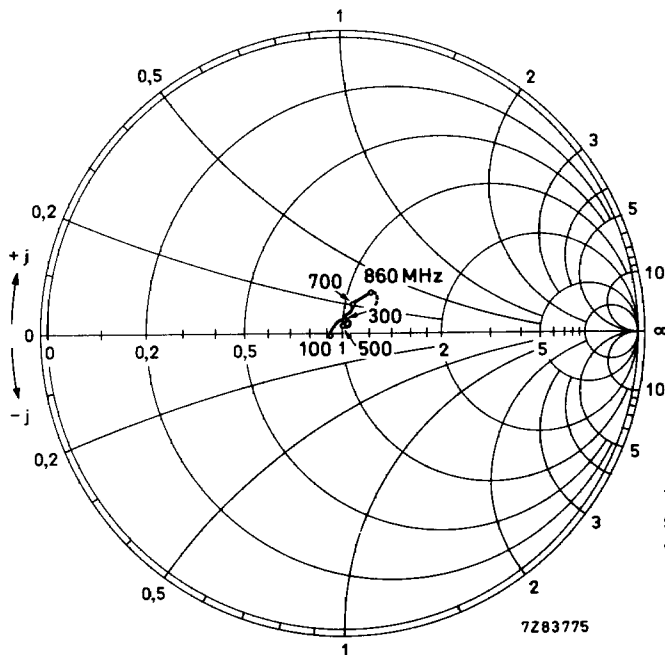

Fig. 6 Output impedance derived from output reflection coefficient s_o , co-ordinates in ohm $\times 75$; typical values.

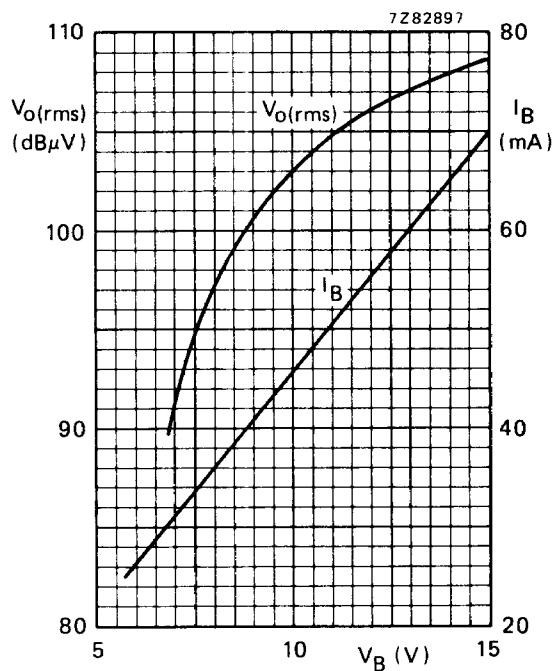

Fig. 7 Output voltage and supply current as a function of the supply voltage; typical values.

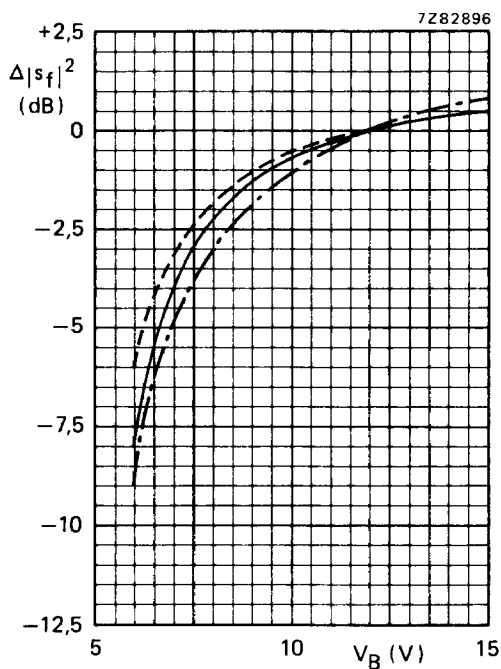

Fig. 8 Variation of transducer gain with supply voltage; reference 0 dB at 12 V;
 — $f = 500$ MHz;
 - - - $f = 100$ MHz;
 - · - $f = 860$ MHz;
 typical values.