

## Errata

**Title & Document Type:** 54501A 100 MHz Digitizing Oscilloscope Service Manual

**Manual Part Number:** 54510-90906

**Revision Date:** February 28, 1989

---

### HP References in this Manual

This manual may contain references to HP or Hewlett-Packard. Please note that Hewlett-Packard's former test and measurement, semiconductor products and chemical analysis businesses are now part of Agilent Technologies. We have made no changes to this manual copy. The HP XXXX referred to in this document is now the Agilent XXXX. For example, model number HP8648A is now model number Agilent 8648A.

### About this Manual

We've added this manual to the Agilent website in an effort to help you support your product. This manual provides the best information we could find. It may be incomplete or contain dated information, and the scan quality may not be ideal. If we find a better copy in the future, we will add it to the Agilent website.

### Support for Your Product

Agilent no longer sells or supports this product. You will find any other available product information on the Agilent Test & Measurement website:

[www.tm.agilent.com](http://www.tm.agilent.com)

Search for the model number of this product, and the resulting product page will guide you to any available information. Our service centers may be able to perform calibration if no repair parts are needed, but no other support from Agilent is available.



**SERVICE MANUAL**

**HP 54501A  
100 MHZ  
DIGITIZING OSCILLOSCOPE**

**SERIAL NUMBERS**

This manual applies directly to instruments with serial numbers prefixed: 2816A, 2833A, 2842A, 2906A and 2913A.

For additional information about serial numbers, see  
INSTRUMENTS COVERED BY MANUAL in Section 1.

© COPYRIGHT HEWLETT-PACKARD COMPANY/COLORADO SPRINGS DIVISION 1988  
1900 GARDEN OF THE GODS ROAD, COLORADO SPRINGS, COLORADO U.S.A.

ALL RIGHTS RESERVED

Manual Part Number 54501-90906  
Microfiche Part Number 54501-90806

**PRINTED: 28 FEBRUARY 1989**

## **CERTIFICATION**

*Hewlett-Packard Company certifies that this product met its published specifications at the time of shipment from the factory. Hewlett-Packard further certifies that its calibration measurements are traceable to the United States National Bureau of Standards, to the extent allowed by the Bureau's calibration facility, and to the calibration facilities of other International Standards Organization members.*

## **WARRANTY**

This Hewlett-Packard product is warranted against defects in material and workmanship for a period of one year from date of shipment. During the warranty period, Hewlett-Packard Company will, at its option, either repair or replace products which prove to be defective.

For warranty service or repair, this product must be returned to a service facility designated by HP. Buyer shall prepay shipping charges to HP and HP shall pay shipping charges to return the product to Buyer. However, Buyer shall pay all shipping charges, duties, and taxes for products returned to HP from another country.

HP warrants that its software and firmware designated by HP for use with an instrument will execute its programming instructions when properly installed on that instrument. HP does not warrant that the operation of the instrument or software, or firmware will be uninterrupted or error free.

## **LIMITATION OF WARRANTY**

The foregoing warranty shall not apply to defects resulting from improper or inadequate maintenance by Buyer, buyer-supplied software or interfacing, unauthorized modification or misuse, operation outside the environmental specifications for the product, or improper site preparation or maintenance.

NO OTHER WARRANTY IS EXPRESSED OR IMPLIED. HP SPECIFICALLY DISCLAIMS THE IMPLIED WARRANTIES OF MERCHANTABILITY AND FITNESS FOR A PARTICULAR PURPOSE.

## **EXCLUSIVE REMEDIES**

THE REMEDIES PROVIDED HEREIN ARE BUYER'S SOLE AND EXCLUSIVE REMEDIES. HP SHALL NOT BE LIABLE FOR ANY DIRECT, INDIRECT, SPECIAL, INCIDENTAL, OR CONSEQUENTIAL DAMAGES, WHETHER BASED ON CONTRACT, TORT, OR ANY OTHER LEGAL THEORY.

## **ASSISTANCE**

*Product maintenance agreements and other customer assistance agreements are available for Hewlett-Packard products.*

*For any assistance, contact your nearest Hewlett-Packard Sales and Service Office. Addresses are provided at the back of this manual.*

## TABLE OF CONTENTS

### SECTION 1. GENERAL INFORMATION

1-1.	Introduction .....	1-1
1-2.	Instruments Covered by Manual .....	1-1
1-3.	Instrument Description.....	1-1
1-4.	Accessories Supplied .....	1-1
1-5.	Accessories Available .....	1-2
1-6.	Specifications .....	1-2
1-7.	Operating Characteristics.....	1-2
1-8.	General Characteristics .....	1-2
1-9.	Recommended Test Equipment.....	1-9

### SECTION 2. INSTALLATION

2-1.	Introduction .....	2-1
2-2.	Initial Inspection.....	2-1
2-3.	Operating Environment .....	2-1
2-4.	Storage and Shipping .....	2-1
2-5.	Packaging .....	2-1
2-6.	Tagging for Service.....	2-1
2-7.	Original Packaging .....	2-1
2-8.	Other Packaging.....	2-1
2-9.	Preparation for Use .....	2-2
2-10.	Power Requirements.....	2-2
2-11.	Line Voltage Selection .....	2-2
2-12.	Power Cable .....	2-2
2-13.	Applying Power.....	2-2
2-14.	Cleaning Requirements .....	2-2

### SECTION 3. PERFORMANCE TESTS

3-1.	Introduction .....	3-1
3-2.	Equipment Required .....	3-1
3-3.	Test Record .....	3-1
3-4.	Selftest Verification.....	3-1
3-5.	Bandwidth Performance Test.....	3-2
3-6.	Offset Accuracy Test.....	3-3
3-7.	Trigger Sensitivity Test.....	3-5
3-8.	Delta-t Accuracy Test .....	3-8
3-9.	Voltage Measurement Accuracy.....	3-9

### SECTION 4. ADJUSTMENTS

4-1.	Introduction .....	4-1
4-2.	Equipment Required .....	4-1
4-3.	Calibration Interval .....	4-1
4-4.	HP 54501A Self Calibration .....	4-1
4-5.	Power Supply Adjustment .....	4-2
4-6.	CRT Monitor Assembly Adjustments .....	4-3

4-6. CRT Monitor Assembly Adjustments ..... 4-3

4-7. Intensity, Sub-bright, and  
Contrast Adjustments ..... 4-3

4-8. Focus Adjustment ..... 4-5

4-9. Horizontal Phase, Vertical Linearity,  
and Height Adjustments ..... 4-5

4-10. System Board Assembly  
Adjustments ..... 4-6

4-11. Extender Cable Installation ..... 4-6

4-12. Default Calibration Load ..... 4-6

4-13. DAC Reference Adjustment ..... 4-7

4-14. Track and Hold Offset Adjustments ..... 4-8

4-15. Attenuator Compensation Adjustments ..... 4-9

4-16. Pulse Response ..... 4-11

4-17. Self Calibration ..... 4-11

4-18. Logic Trigger Delay Calibration ..... 4-13

4-19. Oscillator Output Check ..... 4-14

**SECTION 5. REPLACEABLE PARTS**

5-1. Introduction ..... 5-1

5-2. Abbreviations ..... 5-1

5-3. Replaceable Parts ..... 5-1

5-4. Exchange Assemblies ..... 5-1

5-5. Ordering Information ..... 5-1

5-6. Direct Mail Order System ..... 5-1

**SECTION 6. SERVICE**

6-1. Introduction ..... 6-1

6-2. Safety Considerations ..... 6-1

6-3. Logic Convention ..... 6-1

6-4. Block Level Theory  
of Operation ..... 6-2

6-5. Power Supply Assembly ..... 6-2

6-6. Display Monitor Assembly ..... 6-2

6-7. System Board Assembly ..... 6-2

6-8. Keyboard Assembly ..... 6-2

6-9. System Board Assembly Theory  
of Operation ..... 6-4

6-10. Data Acquisition ..... 6-4

6-11. System Control ..... 6-7

6-12. Troubleshooting ..... 6-9

6-13. Troubleshooting Flowcharts ..... 6-9

6-14. Power Supply Voltages Check ..... 6-16

6-15. CRT Monitor Signals Check ..... 6-17

6-16. Keyboard Signals Check ..... 6-19

6-17. Assembly Removal and  
Installation ..... 6-21

6-18. Removal and Replacement of  
Rear Panel Assembly ..... 6-22

6-19. Removal and Replacement of  
Power Supply Assembly ..... 6-22

6-20.	Removal and Replacement of Keyboard Assembly .....	6-23
6-21.	Removal and Replacement of System Board Assembly .....	6-24
6-22.	Removal and Replacement CRT Monitor Assembly .....	6-25
6-23.	Removal and Replacement of Fan .....	6-26
6-24.	Removal and Replacement of Feet/Tilt Stand .....	6-26
6-25.	HP 54501A Self Tests .....	6-27

**LIST OF TABLES**

1-1.	HP 54501A Specifications and Characteristics .....	1-3
1-2.	HP 54501A Operating Characteristics .....	1-4
1-3.	HP 54501A General Characteristics.....	1-8
1-4.	Recommended Test Equipment .....	1-9
3-1.	Voltage Measurement Accuracy Test Values and Results .....	3-9
6-1.	Power Supply Assembly/System Board Assembly Voltages .....	6-18
6-2.	CRT Monitor Assembly Cable Pin Assignments.....	6-19
6-3.	FB and HB Truth Table.....	6-20
6-4.	HP 54501A Keyboard Connector Voltages and Signals.....	6-21

**LIST OF FIGURES**

2-1.	Power Cord Plug Configurations .....	2-3
3-1.	Bandwidth Performance Test Setup .....	3-3
3-2.	Delta-t Accuracy Test Result .....	3-7
4-1.	HP 54501A Power Supply Assembly Testpoints and Adjustment Locations .....	4-2
4-2.	HP 54501A CRT Test Display .....	4-3
4-3.	Adjustment Locations of HP 54501A CRT Monitor Assembly .....	4-4
4-4.	HP 54501A System Board Assembly Component Locator .....	4-8
5-1.	HP 54501A Exploded View.....	5-2
6-1.	HP 54501A Simplified Block Diagram .....	6-2
6-2.	HP 54501A Acquisition Block Diagram .....	6-5
6-3.	HP 54501A System Control Block Diagram .....	6-8
6-4.	General Trouble Isolation Flowchart for HP 54501A .....	6-11
6-5.	Trouble Isolation Flowchart for HP 54501A Fan/Fuse.....	6-12
6-6.	Trouble Isolation Flowchart for HP 54501A Power Supply.....	6-13
6-7.	Trouble Isolation Flowchart for HP 54501A CRT Monitor .....	6-14
6-8.	Trouble Isolation Flowchart for HP 54501A Keyboard .....	6-15
6-9.	Trouble Isolation Flowchart for HP 54501A Calibration Signals.....	6-16
6-10.	HP 54501A Power Supply Testpoints .....	6-17
6-11.	HP 54501A CRT Monitor Assembly Cable, W6, Location .....	6-20
6-12.	HP 54501A Selftest Menu Selections .....	

## SAFETY CONSIDERATIONS

**GENERAL** - This is a Safety Class I instrument (provided with terminal for protective earthing).

**OPERATION** - BEFORE APPLYING POWER verify that the power transformer primary is matched to the available line voltage, the correct fuse is installed, and Safety Precautions are taken (see the following warnings). In addition, note the instrument's external markings which are described under "Safety Symbols."

### WARNING

- o Servicing instructions are for use by service-trained personnel. To avoid dangerous electric shock, do not perform any servicing unless qualified to do so.
- o BEFORE SWITCHING ON THE INSTRUMENT, the protective earth terminal of the instrument must be connected to the protective conductor of the (mains) powercord. The mains plug shall only be inserted in a socket outlet provided with a protective earth contact. The protective action must not be negated by the use of an extension cord (power cable) without a protective conductor (grounding). Grounding one conductor of a two-conductor outlet is not sufficient protection.
- o If this instrument is to be energized via an auto-transformer (for voltage reduction) make sure the common terminal is connected to the earth terminal of the power source.
- o Any interruption of the protective (grounding) conductor (inside or outside the instrument) or disconnecting the protective earth terminal will cause a potential shock hazard that could result in personal injury.
- o Whenever it is likely that the protection has been impaired, the instrument must be made inoperative and be secured against any unintended operation.
- o Only fuses with the required rated current, voltage, and specified type (normal blow, time delay, etc.) should be used. Do not use repaired fuses or short circuited fuseholders. To do so could cause a shock or fire hazard.
- o Do not operate the instrument in the presence of flammable gasses or fumes. Operation of any electrical instrument in such an environment constitutes a definite safety hazard.

o Do not install substitute parts or perform any unauthorized modification to the instrument.

o Adjustments described in the manual are performed with power supplied to the instrument while protective covers are removed. Energy available at many points may, if contacted, result in personal injury.

o Any adjustment, maintenance, and repair of the opened instrument under voltage should be avoided as much as possible, and when inevitable, should be carried out only by a skilled person who is aware of the hazard involved.

o Capacitors inside the instrument may still be charged even if the instrument has been disconnected from its source of supply.

### SAFETY SYMBOLS



Instruction manual symbol. The product will be marked with this symbol when it is necessary for the user to refer to the instruction manual in order to protect against damage to the product.



Indicates hazardous voltages.



Earth terminal (sometimes used in manual to indicate circuit common connected to grounded chassis).

### WARNING

The WARNING sign denotes a hazard. It calls attention to a procedure, practice, or the like, which, if not correctly performed or adhered to, could result in personal injury. Do not proceed beyond a WARNING sign until the indicated conditions are fully understood and met.

### CAUTION

The CAUTION sign denotes a hazard. It calls attention to an operating procedure, practice, or the like, which, if not correctly performed or adhered to, could result in damage to or destruction of part or all of the product. Do not proceed beyond a CAUTION sign until the indicated conditions are fully understood or met.

## SECTION 1. GENERAL INFORMATION

### Table of Contents

1-1.	Introduction .....	1-1
1-2.	Instruments Covered by Manual .....	1-1
1-3.	Instrument Description.....	1-1
1-4.	Accessories Supplied .....	1-1
1-5.	Accessories Available .....	1-2
1-6.	Specifications .....	1-2
1-7.	Operating Characteristics.....	1-2
1-8.	General Characteristics .....	1-2
1-9.	Recommended Test Equipment.....	1-9



# SECTION 1

## GENERAL INFORMATION

### 1-1. INTRODUCTION

This service manual contains information on installing, testing, adjusting, and servicing the Hewlett-Packard Model 54501A Digitizing Oscilloscope. This section of the manual includes instrument identification, description, options, accessories, specifications and other basic information.

A microfiche part number is listed under the manual part number on the title page of this manual. This number may be used to order 4 X 6-inch microfiche transparencies of the manual. Each microfiche contains up to 96 photo-duplicates of the manual pages. The microfiche package also contains the latest Manual Changes supplement as well as pertinent Service Notes.

### 1-2. INSTRUMENTS COVERED BY MANUAL

On the rear panel of the instrument is a serial number plate. The serial number is in the form: 0000A00000. It is composed of two parts; the first four digits and the letter are the serial prefix and the last five digits are the suffix. The prefix is the same for all identical instruments and changes only when a change has been made to the instrument. The suffix however, is assigned sequentially and is different for each instrument. The contents of this manual apply to instruments with the serial number prefix(es) listed under SERIAL NUMBERS on the title page.

An instrument manufactured after the printing of this manual may have a serial number prefix different than those listed on the title page. This unlisted serial number prefix indicates the instrument is different from those described in this manual. The manual for this instrument is accompanied by a yellow Manual Changes supplement. This supplement contains the necessary "change information" that explains how to adapt the manual to the newer instrument.

In addition to change information, the supplement may contain information for correcting errors in the manual. To keep this manual as accurate as possible, periodically request the latest Manual Change supplement for the instrument manual. The supplement for this manual is identified with the manual part number and print date, both of which appear on the manual title page. Complimentary copies of the supplement are available from Hewlett-Packard.

For information concerning a serial prefix number not listed on the title page or in the Manual Changes supplement, contact your nearest Hewlett-Packard office.

### 1-3. INSTRUMENT DESCRIPTION

The HP 54501A Digitizing Oscilloscope is a general-purpose, 100 MHz bandwidth oscilloscope. The HP 54501A has four input channels, two of which have limited input attenuation. Channels 2 and 3 are limited to an attenuation factor of 10 and optimized for digital signals. Full programmability has been incorporated into the HP 54501A and may be used in a broad range of HP-IB applications, from high-speed ATE to device characterization in a research and development environment. The HP 54501A Digitizing Oscilloscope features powerful triggering, easy waveform storage, automatic measurements and instant hardcopy output.

### 1-4. ACCESSORIES SUPPLIED

The following accessories are supplied with the HP 54501A Digitizing Oscilloscope:

Two **HP 10432A Miniature Passive Probes.**

One miniature probe to BNC male adapter.

One 2.3 metre (7.5 feet) **power cord**. See section 2 for available power cords.

One **Operating and Programming Manual Set**.

One **Service Manual**.

## 1-5. ACCESSORIES AVAILABLE

The following accessories are available for use with the HP 54501A:

**Soft Carrying Case.** *HP Part Number 1540-1066.*

**HP Model 1008A Option 006 Testmobile.**

**Transit Case.** HP Part Number 9211-1645.

## 1-6. OPTIONS AVAILABLE

**Option 908** - HP Rackmount Kit. *HP Part Number 5061-6175.*

**Option 910** - Additional Service Manual and Operating and Programming Manual Set.

**Option 090** - Deletion of probe accessories.

## 1-6. SPECIFICATIONS

Table 1-1 is the list of specifications and characteristics for the HP 54501A Digitizing Oscilloscope. The specifications are the performance standards or limits for which the oscilloscope is tested.

## 1-7. OPERATING CHARACTERISTICS

Table 1-2 is a list of the operating characteristics of the HP 54501A Digitizing Oscilloscope. The operating characteristics are a summary of performance capabilities of the HP 54501A.

## 1-8. GENERAL CHARACTERISTICS

Table 1-3 is general characteristics of the HP 54501A Digitizing Oscilloscope. The general characteristics are useful environmental operating conditions, shipping weights, and instrument dimensions.

## 1-9. RECOMMENDED TEST EQUIPMENT

Table 1-4 is a list of the test equipment required to test performance, make adjustments, and troubleshoot the HP 54501A Digitizing Oscilloscope. The table indicates the critical specification of the test equipment and for which procedure the equipment is necessary. Equipment other than the recommended model may be used if it satisfies the critical specification listed in table 1-4.

Table 1-1. HP 54501A Specifications and Characteristics

SPECIFICATIONS	CHARACTERISTICS
<b>BANDWIDTH:</b>	<b>VERTICAL RESOLUTION:</b>
<b>dc-coupled</b>	$\pm 0.4\%$ - 8-bit A/D
<b>Repetitive:</b> dc to 100 MHz (-3 dB)	(Since expansion is used for 5 mV/div range, A/D resolution is 7 bits [0.8%] in that range.)
<b>Single Shot:</b> dc to 1 MHz	$\pm 0.1\%$ - 10 bits via HP-IB
(Based on 10 points per period of input signal.)	(with averaging)
<b>ac-coupled</b>	
<b>Repetitive:</b> 10 Hz to 100 MHz (-3dB)	<b>MAXIMUM SAMPLE RATE:</b> 10 Msa/s
<b>Single Shot:</b> 10 Hz to 1 MHz	
(Based on 10 points per period of input signal.)	<b>MEMORY DEPTH:</b>
<b>RISETIME:</b> 3.5 ns	<b>501 points (display)</b>
(Calculated from: Risetime = 0.35/Bandwidth.)	<b>1024 points (via HP-IB)</b>
<b>NUMBER OF CHANNELS:</b> 4 (2+2)	(For single-shot via HP-IB, maximum memory depth is 501 points. For 2 ns/div time base range, memory depth is 200 points. For 5 ns/div time base range, maximum memory depth via HP-IB is 501 points.)
Channels 2 and 3 are limited attenuator inputs, optimized for digital signals.	<b>INPUT RC (nominal):</b> 1 M $\Omega$ , 16 pF
<b>SIMULTANEOUS CHANNELS:</b> 2+2	
Channels 1 or 2 simultaneous with 3 or 4. With more than two channels, the other channels are acquired alternately in pairs.	<b>INPUT COUPLING:</b> ac, dc
<b>VERTICAL SENSITIVITY</b>	<b>OFFSET RANGE:</b>
<b>Maximum:</b> 5 mV/div	<b>Sensitivity Range - Available Offset</b>
<b>Minimum:</b> 5 V/div	5 - 50 mV/div $\pm 2V$
<b>VERTICAL GAIN ACCURACY (dc):</b> $\pm 1.5\%$	0.1 - 1 V/div $\pm 20V$
<b>MAX INPUT VOLTAGE:</b> $\pm 250$ V DC + peak ac (<10KHz)	1 - 5 V/div $\pm 200V$
<b>OFFSET ACCURACY:</b>	<b>DYNAMIC RANGE:</b> $\pm 16$ divisions from center
$\pm 2\%$ of offset + 0.2 X (V/div) + .075 div/ $\Delta^\circ$ C from calibration temperature.	Operating range for dc + peak AC input.
(For 5 mV/div range, $\pm 2\%$ of offset + 0.4 X (V/div) + 0.15 div/ $^\circ$ C from calibration temperature.)	<b>CHANNEL-TO-CHANNEL ISOLATION:</b>
<b>VOLTAGE MEASUREMENT ACCURACY (single channel)</b>	(with channels at equal sensitivity)
<b>Single Cursor:</b> Gain Accuracy + offset + A/D resolution	40 dB dc to 20 MHz
<b>Dual Cursor:</b> Gain Accuracy + 2X A/D resolution	30 dB 20 MHz to 100 MHz
<b>TIME BASE RANGE</b>	<b>MAXIMUM TIME BASE RESOLUTION:</b> 100 ps
<b>Minimum:</b> 2 ns/div	
<b>Maximum:</b> 5 s/div	<b>DELAY RANGE (post trigger):</b>
<b>TIME BASE ACCURACY:</b> 0.005%	<b>Time Base Setting - Available Delay</b>
<b>DELTA t ACCURACY:</b>	50 ms- 5 s 40 X (s/div)
$\pm 2\%$ of (t/div) $\pm .005\%$ of Delta t $\pm 1$ ns	100 $\mu$ s - 20 ms 1 s
Delta t accuracy for dual-cursor, single-channel measurement, or for channel-to-channel measurement after visual time null calibration has been done.	2ns - 50 $\mu$ s -10,000 X (s/div)
<b>TRIGGER SENSITIVITY</b>	<b>DELAY RANGE (pretrigger):</b>
<b>5 mv/div:</b>	<b>Time Base Setting Delay</b>
<b>dc-20 MHz</b> 0.1 X full-scale	10 $\mu$ s - 5 s -40 X (s/div)
<b>20 MHz-100 MHz</b> 0.25 X full-scale	20 ns - 5 $\mu$ s -200 $\mu$ s
<b>All other:</b>	2 ns - 10 ns -10,000 X (s/div)
<b>dc-20 MHz</b> 0.05 X full-scale	<b>TRIGGER PULSE WIDTH (minimum):</b> 7 ns
<b>20 MHz-100 MHz</b> 0.125 X full-scale	<b>TRIGGER LEVEL RANGE:</b> $\pm 6$ div from center
<i>Specifications valid for temperature range <math>\pm 10^\circ</math> C calibration temperature with 8 averages selected and channel(s) in sensitivity range 1, 2, or 5.</i>	

Table 1-2. HP 54501A Operating Characteristics

**VERTICAL**

**Deflection factors: Channels 1 and 4:** With single screen selected, attenuation factors are adjustable from 5 mV/div to 5 V/div in a 1-2-5 sequence with the knob. Finer adjustments may be made using direct keypad entry or the knob with the FINE key selected.

**Channels 2 and 3:** With single-screen mode selected, attenuation factors are adjustable from 100 mV/div to 500 mV/div in a 1-2-5 sequence with the knob. Finer adjustments may be made using direct keypad entry or the knob with the FINE key selected.

**Probe attenuation factors:** Values from 0.9 to 1K may be entered to scale the oscilloscope for external probes or attenuators attached to the channel inputs. When probe tip calibration is performed, this value is calculated automatically.

**Bandwidth limit (HF Reject):** May be selected for each individual input to provide a low-pass filter with a -3 dB point at approximately 20 MHz for both triggering and signal display.

**ECL/TTL Presets:** vertical deflection factor, offset, and trigger level may be preset independently on each channel for ECL and TTL levels.

**HORIZONTAL**

**Dual time base windowing:** Allows user to zoom in on user-defined portion of the waveform using cursors that are displayed on the top half of the screen. An expanded time base is displayed on the lower half of the screen. The window time base may be set to provide as much as a 20:1 expansion ratio.

Waveform measurements are performed on the dual time base window information when windowing is turned on.

**Delay between channels:** difference in delay between channels may be nulled out to compensate for differences in input cables or probe length. Use the *time null cal* found in the Utility menu.

**Reference location:** The reference point may be located at the left edge, center, or right edge of the display. For zero delay, the reference point is the trigger point. For non-zero delay, the reference point is equal to the trigger point plus the delay time.

**TRIGGER MODES**

**Edge trigger:** Positive or negative edge may be selected for trigger on any of the four channel inputs.

**Pattern trigger:** A pattern may be specified using all four of the inputs. Each of the inputs may be specified as a *high*, *low*, or *don't care* with respect to the level setting in the edge trigger menu. Trigger may be selected to occur on the last edge to enter the specified pattern or the first edge to exit the specified pattern.

**Time-qualified pattern trigger:** A trigger will occur on the first edge to exit a pattern, only if it meets the specified time criteria. The available time-qualified modes are:

pattern present less than [time] pattern present  
greater than [time] range-pattern present  
greater than [time1] and less than [time2]

The time [time] settings are adjustable from 20 ns to 160 ms ( $\pm 3\%$   $\pm 2$  ns). The time filter recovery time is less than or equal to 12 ns. In the PATTERN PRESENT LESS THAN [TIME] mode, the pattern must be present greater than 7 ns for the trigger to respond.

**Glitch trigger:** Use PATTERN PRESENT LESS THAN [TIME] with [time] selected such that is just under the pulse width of the signal you are analyzing. The minimum capturable glitch width is 7 ns.

**State trigger:** A pattern is specified on any three of the four inputs with the fourth input used as a clock. A trigger will occur on the rising or falling edge of the input specified as the clock. A trigger will occur on the rising or falling edge of the input specified as the clock when the pattern is present or not present. Setup time for the pattern with respect to the clock is less than or equal to 10 ns; hold time is zero.

Table 1-2. HP 54501A Operating Characteristics (continued)

**TRIGGER MODES (continued)****DELAYED TRIGGER:**

**Event-delayed mode:** The trigger may be qualified by an edge, pattern, time-qualified pattern or state. The delay may be specified as a number of occurrences of a rising or falling edge of the input specified as the clock when the pattern is present or not present. The trigger is an occurrence of a rising or falling edge of any of the four inputs. The occurrence values may be set from 1 to 16,000,000. The maximum edge-counting rate is 100 MHz.

**Time-delayed mode:** The trigger may be qualified by an edge, pattern, time-qualified pattern or state. The delay is selectable from 30 ns to 160 ms. The trigger is an occurrence of a rising or falling edge of any of the four inputs. The number of occurrences may be set from 1 to 16,000,000. The maximum edge counting rate is 100 MHz.

**TV TRIGGER**

**60 Hz / 525 lines:** Source may be selected to be any of the four inputs. Trigger level is adjustable for the selected source. Polarity is selected for positive or negative synchronizing pulses. A trigger occurs on the selected line and field of a 2/1 interlaced composite video signal. Line numbering is 1 to 263 for field 1 and 1 to 262 for field 2. This TV trigger mode is compatible with broadcast standard M.

**50 Hz / 625 lines:** Same as 60 Hz / 525 lines, except numbering is 1 to 313 for field 1 and 314 to 625 for field 2. This TV trigger mode is compatible with broadcast standards: B,C,D,G,H,I,K,K1,L and N.

**User-defined mode:** Source may be selected to be any one of the four inputs. Trigger level is adjustable for the selected source. The trigger is qualified with a high or low pulse that meets a selectable time range. The trigger is an occurrence of a rising or falling edge of the source after the qualifying pulse. The time settings for the qualifier are selectable from 20 ns to 160 ms. The trigger occurrence value is selectable from 1 to 16,000,000.

**NOTE:** All TV trigger modes require a clamped video signal for stable triggering. Use the HP 1133A TV/Video Sync Pod to provide clamped video output that can be used with the HP 54501A's TV triggering capabilities.

**Holdoff:** Holdoff is adjustable in 20 ns steps from 40 ns to 320 ms. A separate holdoff setting is available for each trigger mode except DELAYED TRIGGER, which is fixed to 40 ns.

**Waveform Math**

Two independent functions are provided for waveform math. The operators are +, -, X, VS, INVERT and ONLY. The vertical channels on any of the waveform memories may be used as operands for the waveform math. Sensitivity and offset for these functions may be adjusted independently.

**Waveform Save**

Four non-volatile memories and two volatile pixel memories are provided. Waveform memories store single-valued waveforms, such as an averaged waveform. If an envelope waveform is stored to a memory waveform, it will automatically be stored with the upper waveform in one waveform memory and the lower waveform in another. Pixel memories store an entire screen of waveform data. They are very useful for storing multiple, overlapping waveforms and infinite persistence waveforms.

**DISPLAY**

**Data display resolution:** 451 points horizontally by 256 points vertically.

**Number of screens:** 1, 2, or 4 screens can be selected. This allows the overlapping of channels or memories for comparison, or viewing them on up to 4 data display areas.

**Display Modes**

**Minimum persistence:** One waveform data value is displayed in each horizontal position of the display. The waveform is updated as the new data is acquired for a particular horizontal position.

Table 1-2. HP 54501A Operating Characteristics (continued)

**Display Modes (continued)**

**Variable persistence:** The time that each data point is retained on the display may be varied from 200 ms to 10 seconds, or it may be displayed infinitely.

**Averaging:** The number of averages, (n) may be specified in powers of 2, up to 2048. On each acquisition, 1/n times the new data is added to (n-1)/n of the previous value at each time coordinate. Averaging operates continuously, except for the HP-IB DIGITIZE command, for which averaging terminates at a user-specified number of averages.

**Envelope:** Provides a display of the running maximum and minimum voltage levels at each horizontal position of a repetitive waveform.

**Graticules:** The user may select full grid, axes, frame, or no graticule.

**Connect-the-dots:** Provides a continuous display, connecting the sample points with straight lines. Connect-the-dots is operative for modes in which a single valued waveform can be connected, including AVERAGE, ENVELOPE, and MINIMUM PERSISTENCE modes.

**Scroll mode:** The HP 54501A automatically selects scroll mode at time-per-division settings from 200 ms/div to 5 s/div if the scope is in AUTO mode, or if the scope is in TRIGGERED mode with the delay at the left edge of the display set is greater than or equal to 0. Scroll mode updates each data point on the displayed waveform as the data is acquired.

**DELTA V / DELTA t Markers:** dual voltage markers and dual time markers are provided. Voltage markers may be independently assigned to channels, memories, or functions.

**AUTOMATIC PARAMETRIC MEASUREMENTS**

**Automatic Pulse Parameter Measurements:** The HP 54501A performs 16 automatic pulse parameter measurements from the front panel and additional measurements via HP-IB including ALL, OVERSHOOT, and PRESHOOT. The standard

measurements are performed with 10%, 50%, and 90% voltage thresholds, as defined by IEEE Standard 194-1977, "IEEE Standard Pulse Terms and Definitions".

**User-definable Measurement Thresholds:** The HP 54501A lets you set your own thresholds for automatic measurements. Both the upper and the lower thresholds may be set from 0% to 100% as long as the upper threshold value is greater than or equal to the lower threshold. The mid threshold is always equal to the mid-value between the upper and lower threshold.

**Continuous measurements:** may be turned on or off. With continuous measurements off, the voltage and time markers are placed on the waveform to indicate where the measurement is taken.

**Measurement Statistics:** The maximum, minimum, average, and most recent of continuously updated measurements are calculated and displayed. Any three measurements may be selected.

**Measurement Limit Test:** Maximum and minimum limits may be set for three of the automatic measurements. These continuously updated measurements are compared to the maximum and minimum limits. If the measurements are found to be outside the defined limits, the acquisition is stopped and the waveform can be stored to a memory or the screen can be sent to a printer. In addition, an HP-IB Service Request can be generated, so a controller can be flagged to request the waveform and the measurement information via HP-IB.

**SETUP AIDS**

**Autoscale:** Pressing the Autoscale button automatically adjusts the vertical and horizontal deflection factors as well as the trigger level for a display appropriate to the signals applied to the inputs. The Autoscale feature requires a signal with a duty cycle greater than 0.5% and a frequency greater than 50 Hz.

Table 1-2. HP 54501A Operating Characteristics

**SETUP AIDS (continued)**

**Save/Recall:** Four front-panel setups (1-4) may be saved in non-volatile memory.

**Recall Clear:** Resets the HP 54501A to its factory default settings.

**Recall 0:** If Autoscale, ECL, or TTL preset, or RECALL SETUP are inadvertently selected, RECALL 0 restores the memory to its last state prior to selection.

**Show:** Displays instrument status, including volts/div, offset, and trigger condition.

**HARDCOPY:** The CRT display, including menus and measurement results, can be transferred directly to an HP-IB graphics printer, including the HP 2225A ThinkJet® or compatible printers.

**HP-IB PROGRAMMABILITY**

**Full Programmability:** The HP 54501A provides full programmability. Instrument settings and operating modes, including automatic

measurements, may be remotely programmed via HP-IB (IEEE 488). HP-IB programming complies with IEEE 488.2-1988 "Standard Codes, Formats, Protocols, and Common Commands".

**Data Acquisition and Transfer Rate:** A 500-point data record can be acquired and transferred to a computer at a rate of approximately 10 times per second, as tested with an HP 9000, Series 200 Controller. The acquired data was type normal, completion criteria 100% with the oscilloscope at a time/div setting of 5  $\mu$  s/div.

**Data Transfer Rates:** Approximately 120 Kbytes/s.

**Probe Compensation Output:** An approximately 1.5 MHz signal is provided for probe compensation. A probe-to-BNC adapter is used to connect the probe to the rear panel Probe Compensation BNC output. During calibration, this output is used to provide other calibration signals.

**DC Calibrator Output:** This output is used for vertical calibration of the HP 54501A.

Table 1-3. HP 54501A General Characteristics

**Environmental Conditions**

**Temperature**

Operating: 0° C to + 55° C.  
 Non-operating: -40° C to 70° C.

**Humidity**

Operating: up to 95% relative humidity (non-condensing) at 40° C.  
 Non-operating: up to 90% relative humidity at 65° C.

**Altitude**

Operating: up to 4600 meters (15 000 ft).  
 Non-operating: up to 15 300 meters (50 000 ft).

**Vibration**

Operating: Random vibration 5-500 Hz, 10 minutes per axis, 0.3 G(rms).  
 Non-operating: Random vibration 5-500 Hz, 10 minutes per axis, 2.41 G(rms).  
 Resonant search: 5 to 500 Hz swept sine, 1 octave/minute sweep rate, (0.75g), 5 minute resonant dwell @ 4 resonances per axis.

**Power Requirements**

Voltage: 115/230 Vac, -25% to +15%, 48-66 Hz.  
 Power: 350 VA maximum.

**Weight**

Net: approximately 10 kg (22 lb).  
 Shipping: approximately 20 kg (44 lb).

**Dimensions**

Refer to outline drawings below.

**NOTES**

1. Dimensions are for general information only. If dimensions are required for building special enclosures, contact your HP field engineer.
2. Dimensions are in millimetres and (inches).

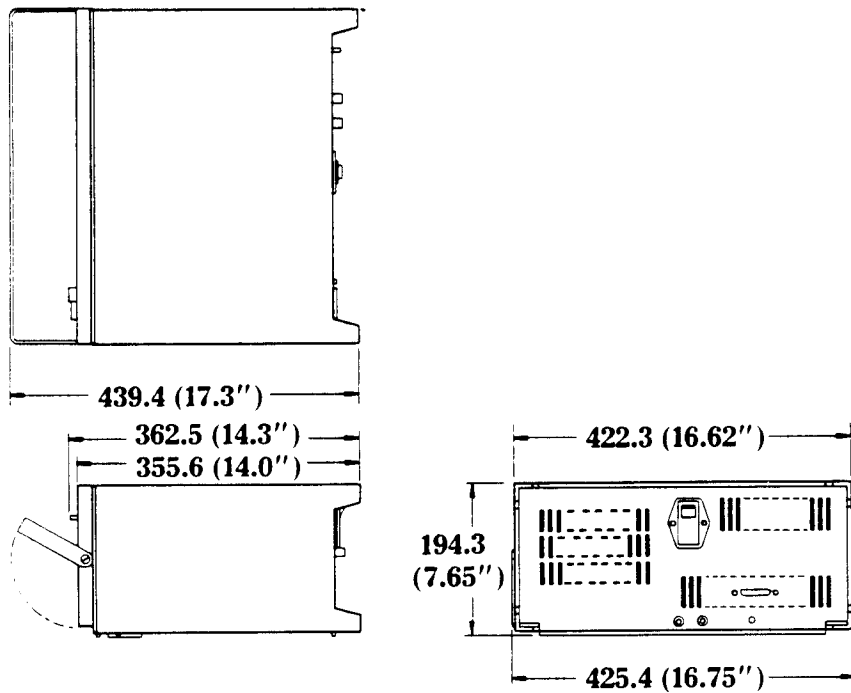



Table 1-4. Recommended Test Equipment

REQUIRED	CRITICAL SPECIFICATIONS	RECOMMENDED	USE*
DMM	5 1/2 digit resolution	HP 3478A	A, T
OSCILLOSCOPE	100 MHz BW high-z input w/10:1 probe	HP 54501A	A
PULSE GENERATOR	<70 ps risetime	Tektronix 284	A
POWER SUPPLY	30 mV to 30 V 0.025% accuracy	HP 6114A	P
SIGNAL GENERATOR	100 MHz .003% accuracy	HP 8656B	P
SQUARE-WAVE GENERATOR	100 Hz to 1 kHz 300 mV p-p to 5 V p-p	HP 8116A	A
POWER METER	100 MHz frequency range .02 dB accuracy	HP 436A	P
POWER SENSOR	HP 436A compatibility	HP 8482A	P
BNC TEE	(m) to (f) (f)	HP 1250-0781	P
50 OHM TERMINATION	Accuracy: $\pm 1\%$	HP 10100C	A, P
TYPE N (m) CABLE	24 inches (m) to (m)	HP 11500B	A, P
TYPE N (f) BNC ADAPTER	N (f) to BNC (f)	HP 1250-1474	P
BNC 50 OHM ADAPTER	BNC (f) to dual banana plug (m)	HP 1251-2277	A, P
BNC CABLE	48 inches	HP 10503A	A, P
EXTENDER CABLE	no substitute	HP 54503-61604	A
RESISTOR	2 ohms, 25 Watts	HP 0811-1390	T
* P=Performance Tests      A=Adjustments      T=Troubleshooting			



## SECTION 2. INSTALLATION

### Table of Contents

2-1.	Introduction .....	2-1
2-2.	Initial Inspection.....	2-1
2-3.	Operating Environment .....	2-1
2-4.	Storage and Shipping .....	2-1
2-5.	Packaging .....	2-1
2-6.	Tagging for Service.....	2-1
2-7.	Original Packaging .....	2-1
2-8.	Other Packaging.....	2-1
2-9.	Preparation for Use .....	2-2
2-10.	Power Requirements.....	2-2
2-11.	Line Voltage Selection .....	2-2
2-12.	Power Cable .....	2-2
2-13.	Applying Power .....	2-2
2-14.	Cleaning Requirements .....	2-2



## SECTION 2 INSTALLATION

### 2-1. INTRODUCTION

This section of the manual contains information and instructions necessary for installing the HP 54501A Digitizing Oscilloscope. Included in this section are inspection procedures, power requirements, hardware connections and configurations, and packaging information.

### 2-2. INITIAL INSPECTION

Inspect the shipping container for damage. If the shipping container or cushioning material is damaged, it should be kept until the contents of the shipment have been checked for completeness and the instrument has been checked mechanically and electrically. Accessories supplied with the instrument are listed under Accessories Supplied in section 1 of this manual. The self test procedure is described in this section and electrical performance verification functions are described in section 5. If the contents are incomplete, if there is mechanical damage or defect, or if the instrument does not pass the Self Test Performance Verification, notify the nearest Hewlett-Packard Office. If the shipping container is damaged, or the cushioning materials show signs of stress, notify the carrier as well as the Hewlett-Packard Office. Keep the shipping materials for carrier's inspection. The Hewlett-Packard office will arrange for repair or replacement at HP option without waiting for claim settlement.

### 2-3. OPERATING ENVIRONMENT

The operating environment for the HP 54501A is described in table 1-2. Note the non-condensing humidity limitation. Condensation within the instrument cabinet can cause poor operation or malfunction. Protection should be provided against temperature extremes which cause condensation within the instrument.

### 2-4. STORAGE AND SHIPPING

This instrument may be stored or shipped in environments within the following limitations:

TEMPERATURE..... -40° C TO 75° C  
HUMIDITY..... UP TO 90% AT 65° C  
ALTITUDE..... UP TO 15 300 METRES (50 000 FEET)

### 2-5. PACKAGING

#### 2-6. Tagging for Service

If the instrument is to be shipped to a Hewlett-Packard office for service or repair; attach a tag to the instrument identifying owner, address of owner, complete instrument model and serial numbers, and a description of the service required.

#### 2-7. Original Packaging

If the original packaging material is unavailable or unserviceable, materials identical to those used in factory packaging are available through Hewlett-Packard offices. If the instrument is to be shipped to a Hewlett-Packard office for service, attach a tag showing owner, address of owner, complete instrument model and serial numbers, and a description of the service required. Mark the container FRAGILE to ensure careful handling. In any correspondence, refer to the instrument by model number and full serial number.

#### 2-8. Other Packaging

The following general instructions should be followed for repacking with commercially available materials.

- a. Wrap instrument in heavy paper or plastic.

- b. Use strong shipping container. A double-wall carton made of 350 lb. test material is adequate.
- c. Use a layer of shock-absorbing material 70 to 100 mm (3 to 4 inches) thick around all sides of instrument to firmly cushion and prevent movement inside the container. Protect control panel with cardboard.
- d. Seal shipping container securely.
- e. Mark shipping container FRAGILE to ensure careful handling.
- f. In any correspondence, refer to instrument by model number and full serial number.

## 2-9. PREPARATION FOR USE

### 2-10. Power Requirements

The HP 54501A requires a power source of either 115 or 230 Vac, -22% to +10%; single phase, 48 to 66 Hz; 200 Watts maximum power.



**BEFORE CONNECTING POWER TO THIS INSTRUMENT**, be sure the line voltage switch on the rear panel of the instrument is set properly and the correct fuse is installed.

### 2-11. Line Voltage Selection

Before setting instrument power switch to ON position, verify that the fuse module is in the correct position for the line voltage.

The fuse module is located in the line filter/power switch module on the rear panel of the instrument.

If the arrow beside the voltage on the fuse module that is in-line with the filter arrow does not match line voltage to be used, it must be changed. To select the proper fuse for line

voltage, gently pry out fuse module with a flat-blade screwdriver. To use other fuse in module, turn fuse module and reinsert into the line filter module.

## 2-12. POWER CABLE

### WARNING

**BEFORE CONNECTING THIS INSTRUMENT**, the protective earth terminal of the instrument must be connected to the protective conductor of the (Mains) power cord. The Mains plug must be inserted in a socket outlet provided with a protective earth contact. The protective action must not be negated by the use of an extension cord (power cable) without a protective conductor (grounding). Grounding one conductor of a two conductor outlet does not provide an instrument ground.









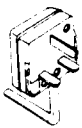

This instrument is provided with a three-wire power cable. When connected to an appropriate AC power outlet, this cable grounds the instrument cabinet. The type of power cable plug shipped with the instrument depends on the country of destination. Refer to figure 2-1 for power plugs and HP part numbers for the available plug configurations.

## 2-13. APPLYING POWER

After applying power to the HP 54501A, an internal selftest may be performed by following the procedure in section 3. If the message "**cal ram checksum error re-cal instrument**" is displayed at the top of the screen, refer to **HP 54501A SELF CALIBRATION** in section 4 of this manual.

## 2-14. CLEANING REQUIREMENTS

Use **MILD SOAP AND WATER** to clean the HP 54501A cabinet and front panel. Care must be taken not to use a harsh soap which will damage the water-base paint finish of the instrument.

PLUG TYPE	CABLE PART NO.	PLUG DESCRIPTION	LENGTH IN/CM	COLOR	COUNTRY
OPT 250V 900 	8120-1351 8120-1703	Straight *BS1363A 90°	90/228 90/228	Gray Mint Gray	United Kingdom. Cyprus. Nigeria. Zimbabwe. Singapore
OPT 250V 901 	8120-1369 8120-0696	Straight *NZSS198/ASC 90°	79/200 87/221	Gray Mint Gray	Australia. New Zealand
OPT 250V 902 	8120-1689 8120-1692 8120-2857	Straight *CEE7-Y11 90° Straight (Shielded)	79/200 79/200 79/200	Mint Gray Mint Gray Coco Brown	East and West Europe. Saudi Arabia. So. Africa. India (Unpolarized in many nations)
OPT** 125V 903 	8120-1378 8120-1521 8120-1992	Straight *NEMA5-15P 90° Straight (Medical) UL544	90/228 90/228 96/244	Jade Gray Jade Gray Black	United States. Canada. Mexico. Philippines. Taiwan.
OPT** 250V 904 	8120-0698	Straight *NEMA6-15P	90/228	Black	United States. Canada
OPT 250V 905 	8120-1396 8120-1625	CEE22-V1 (System Cabinet Use) 250V	30/76 96/244	Jade Gray	For interconnecting system components and peripherals. United States and Canada only
OPT 250V 906 	8120-2104 8120-2296	Straight *SEV1011 1959-24507 Type 12 90°	79/200 79/200	Mint Gray Mint Gray	Switzerland
OPT 220V 912 	8120-2956 8120-2957	Straight *DHCK107 90°	79/200 79/200	Mint Gray Mint Gray	Denmark
OPT 250V 917 	8120-4211 8120-4600	Straight SABS164 90°	79/200 79/200	Jade Gray	Republic of South Africa India
OPT 100V 918 	8120-4753 8120-4754	Straight Mits 90°	90/230 90/230	Dark Gray	Japan

\*Part number shown for plug is industry identifier for plug only. Number shown for cable is HP Part Number for complete cable including plug  
 \*\*These cords are included in the CSA certification approval of the equipment.  
 E = Earth Ground  
 L = Line  
 N = Neutral

Figure 2-1. Power Cord Plug Configurations





## SECTION 3. PERFORMANCE TESTS

### Table of Contents

3-1.	Introduction .....	3-1
3-2.	Equipment Required .....	3-1
3-3.	Test Record .....	3-1
3-4.	Selftest Verification.....	3-1
3-5.	Bandwidth Performance Test.....	3-2
3-6.	Offset Accuracy Test.....	3-3
3-7.	Trigger Sensitivity Test.....	3-5
3-8.	Delta-t Accuracy Test .....	3-8
3-9.	Voltage Measurement Accuracy .....	3-10
	Performance Test Record .....	3-11



## SECTION 3

# PERFORMANCE TESTS

### 3-1. INTRODUCTION

This section provides procedures to test the electrical performance of the HP 54501A according to the specifications in table 1-1 of this manual. Although the HP 54501A internal selftests provide a high confidence level of system functions, the performance test procedures may be performed upon incoming inspection of the HP 54501A and periodically to ensure and maintain peak performance.

### 3-2. EQUIPMENT REQUIRED

Equipment required for the performance tests in this section is listed in the Recommended Test Equipment table in Section 1. Any equipment that satisfies the critical specification listed in the table may be substituted for the recommended model.

### 3-3. TEST RECORD

The results of the performance tests may be tabulated on the Test Record provided at the end of this section. The Test Record lists the performance tests and provides an area to mark test results. The results recorded in the table at incoming inspection may be used for later comparisons of the tests during periodic maintenance, troubleshooting, and after repairs or adjustments.

### 3-4. SELFTEST VERIFICATION

To verify a high confidence level of system operation without the test equipment necessary for the performance tests in this section, the HP 54501A selftests may be performed. The internal tests verify functions on the System Board Assembly of the HP 54501A. The functions tested are the six separate memories and five other functions of the board. To invoke the HP 54501A **SELFTEST**

**MENU**, press front-panel **UTIL** key and then select **selftest menu** softkey. A message will be displayed with the instruction to remove all inputs to the HP 54501A. Selecting **test all** softkey will invoke a loop which runs all the selftests in succession. During execution of the selftests, the following messages will be displayed as each selftest is completed:

**PASSED System RAM**  
**PASSED Non-Volatile RAM**  
**PASSED Display RAM**  
**PASSED Protected Non-Volatile RAM**  
**PASSED System ROM**  
**PASSED Acquisition RAM**  
**PASSED Logic Trigger**  
**PASSED Timebase**  
**PASSED D/A Converter**  
**PASSED HP-IB**  
**PASSED A/D Converter**

When one of the self tests have failed, **FAILED** will be displayed rather than **PASSED**, and a 16-bit diagnostic code will be displayed. This code is used by factory service personnel when troubleshooting the System Board Assembly. Failure of any of these selftests indicate a failure on the System Board Assembly which must be returned to the factory for service. For more information on service, refer to section 6 of this manual.

#### NOTE

*The **loop** test in the **SELFTEST MENU** is a troubleshooting aid for factory service only.*

### 3-5. BANDWIDTH PERFORMANCE TEST

**Specification:**

DC to 100 MHz (Repetitive)  
DC to 1 MHz (Single-shot)

**Equipment Required:**

Signal Generator .....	HP 8656B
Power Meter .....	HP 436A
Power Sensor .....	HP 8482A
Type N (f) BNC (f) Adapter .....	HP 1250-1474
BNC Cable .....	HP 10503A
BNC tee .....	HP 1250-0781

**Procedure:**

1. Connect equipment as in figure 3-1.
2. Set Signal Generator frequency to approximately 100 kHz.
3. Autoscale HP54501A by pressing front-panel AUTOSCALE key.
4. Press front-panel DISPLAY key and select **grid**.
5. Press front-panel CHANNEL and set vertical sensitivity to **100 mV/div**.
6. Adjust Signal Generator output for vertical deflection on HP 54501A of exactly 8 divisions. Adjust **offset** as necessary.
7. Set Power Meter CAL FACTOR % for 100 kHz value from Power Sensor CAL FACTOR % chart.
8. Press Power Meter %[REF] key to set 0 dB reference.
9. Change Signal Generator frequency to 100 MHz.
10. Select HP 54501A **TIMEBASE** and set at 10 nsec/div. Adjust trigger level, if necessary, for stable display.
11. Set Power Meter CAL FACTOR % for 100 MHz value from Power Sensor CAL FACTOR % chart.
12. Adjust Signal Generator output level to obtain 0 dB on Power Meter.
13. Deflection of displayed signal should be equal to or greater than 5.6 divisions in amplitude.
14. Repeat steps 1 through 14 to test channels 2, 3, and 4.

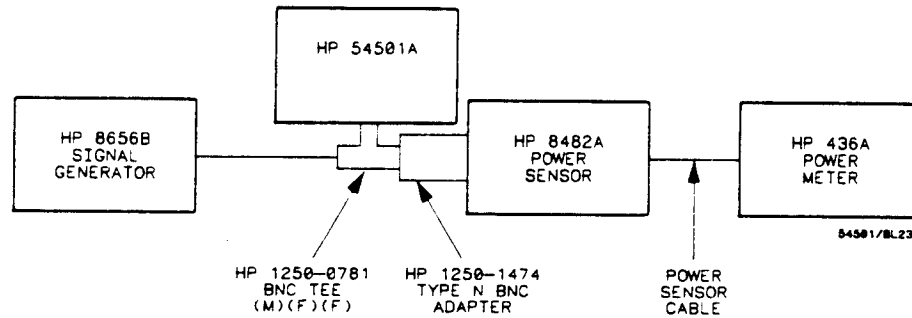

Figure 3-1. Bandwidth Performance Test Setup

### 3-6. OFFSET ACCURACY TEST

**Specification:**

$$\pm 2\% \text{ of offset} + 0.2 \times (\text{V/div}) + .075 \text{ div}/\Delta^\circ\text{C}$$

$$5 \text{ mV range, } \pm 2\% \text{ of offset} + 0.4 \times (\text{V/div}) + 0.15 \text{ div}/\Delta^\circ\text{C}$$

**Equipment Required:**

Power Supply ..... HP 6114A  
 BNC 50-ohm Adapter ((f) dual to banana plug (m)) ..... HP 1251-2277

**Procedure:**

1. Connect Power Supply to HP 54501A Channel 1 input.
2. Adjust Power Supply for +1 V output.
3. Press HP 54501A front-panel CHAN key.
  - a. Select channels 1 on.
  - b. Select 100 mV/div.
  - c. Set coupling to dc.
  - d. Set offset to 1 V.
4. Check for baseline within 0.4 divisions of center reference.

5. Repeat steps 1 through 4 for channels 2 through 4.
6. Adjust Power Supply for +50 mV output.
7. Press HP 54501A front-panel CHAN key.
  - a. Select channel **1 on**.
  - b. Select **5 mV/div**. ✓
  - c. Set coupling to **dc**.
  - d. Set **offset** to **+50 mV**.
8. Press HP 54501A front-panel display key.
  - a. Select **avg** mode.
  - b. Set **#of avg** to **2048**. ✓
9. Check for baseline within 0.6 divisions of center reference.

**NOTE**

*This performance test is temperature sensitive. Test limits in steps 4, 8, and 9 are with instrument operating at same temperature as when calibrated. If temperatures are not the same, the error will be increased by  $0.075 \text{ div}/\Delta^\circ\text{C}$  ( $0.15 \text{ div}/\Delta^\circ\text{C}$  on 5 mV/div range).*

10. Repeat steps 7 through 9 for channel 4.

**3-7. TRIGGER SENSITIVITY TEST**

**Specification:**

5 mV/div	dc - 20 MHz	0.1 X full-scale
	20 MHz - 100 MHz	0.25 X full-scale
All other	dc - 20 MHz	0.05 X full-scale
	20 MHz - 100 MHz	0.125 X full-scale

**Equipment Required:**

Signal Generator ..... HP 8656B  
 Type N Cable..... HP 11500B

**Procedure:**

1. Connect Signal Generator to HP 54501A Channel 1 input.
2. Set Channel 1 vertical sensitivity to **5 mV/div**.
  - a. Press front-panel CHAN key.
  - b. Select **5 mV/div** with knob, softkey, or ENTRY keys.
3. Set Signal Generator for 10 MHz output, adjusting output level for approximately 8 divisions of vertical deflection on HP 54501A. Use HP 54501A AUTOSCALE as necessary.
4. Set HP 54501A DISPLAY menu for 2048 averages.
  - a. Press front-panel DISPLAY key.
  - b. Select **avg** with softkey.
  - c. Enter **2048** with knob or ENTRY keys.
5. Press HP 54501A front-panel TRIG key and adjust trigger **level** as necessary for stable display.

**NOTE**

*The display of the HP 54501A is improved by using averaging mode, however, the rate of display refresh is slowed considerably because of the averaging process.*

6. Slowly decrease Signal Generator output amplitude while adjusting HP 54501A trigger **level** for stable display.
  - a. Press front-panel TRIG key.
  - b. Adjust trigger **level** with knob or ENTRY keys.
7. Stable triggering should be possible down to at least 0.8 divisions of vertical amplitude.
8. Change Signal Generator output for approximately 50 MHz, and increase amplitude for about 8 divisions of vertical amplitude on HP 54501A.
9. Set HP 54501A TIMEBASE for **10ns/div**.
  - a. Press front-panel TIMEBASE key.
  - b. Select **10 ns/div** with knob or softkey.
10. Slowly decrease Signal Generator output amplitude while adjusting HP 54501A trigger level for stable display.
11. Stable triggering should be possible down to 2 divisions of vertical amplitude.
12. Set HP 54501A vertical sensitivity to **200 mV/div**.
13. Change Signal Generator output to 10 MHz and output amplitude level for approximately 8 divisions of vertical amplitude on HP 54501A.
14. Slowly decrease Signal Generator amplitude while adjusting HP 54501A trigger level to maintain a stable display.
15. Stable triggering should be possible down to 0.4 division of vertical amplitude.



16. Change Signal Generator output for 50 MHz and amplitude level for 8 division vertical display on HP 54501A.
17. Change HP 54501A TIMEBASE to **10 ns/div**.
  - a. Press front-panel TIMEBASE key.
  - b. Select **10 ns/div** with knob or ENTRY keys.
18. Slowly decrease Signal Generator amplitude while maintaining stable triggering on HP 54501A.
19. Triggering should be stable down to 1 division of signal amplitude.
20. Repeat steps 1 through 20 for Channel 4.
21. Repeat steps 12 through 20 for Channels 2 and 3.

### 3-8. DELTA-T ACCURACY TEST

**Specification:**

+/- 2% of (t/div) +/- .005% of Delta t +/- 1 ns

Delta-t accuracy for dual-cursor, single-channel measurement, or for channel-to-channel measurement after visual time null calibration has been done.

**Equipment Required:**

Signal Generator ..... HP 8656B  
BNC Cable ..... HP 10503A

**Procedure:**

1. Set Signal Generator for 100 MHz output.
2. Connect Signal Generator to HP 54501A Channel 1 input.
3. Autoscale HP 54501A by pressing front-panel AUTOSCALE key.
4. Adjust Signal Generator output level for 6 to 8 division vertical deflection on HP 54501A.
5. Change TIMEBASE to 5 ns/div.
6. Set TIMEBASE **delay** for 0.00000 s.
7. Go to DISPLAY menu and set **# of averages 2048**.
8. Select delta-t menu by pressing  $\Delta t/\Delta V$  key.
9. Select  **$\Delta t$  markers on**.
10. Set **start marker** to mid-screen crossover point on left side of displayed signal as in figure 3-2.
11. Set **stop marker** to mid-screen crossover point on right side of displayed signal as in figure 3-2.
12. Measure of **delta t** at bottom of display should be **40ns  $\pm$  1.3 ns (38.7 ns to 41.3 ns)**.

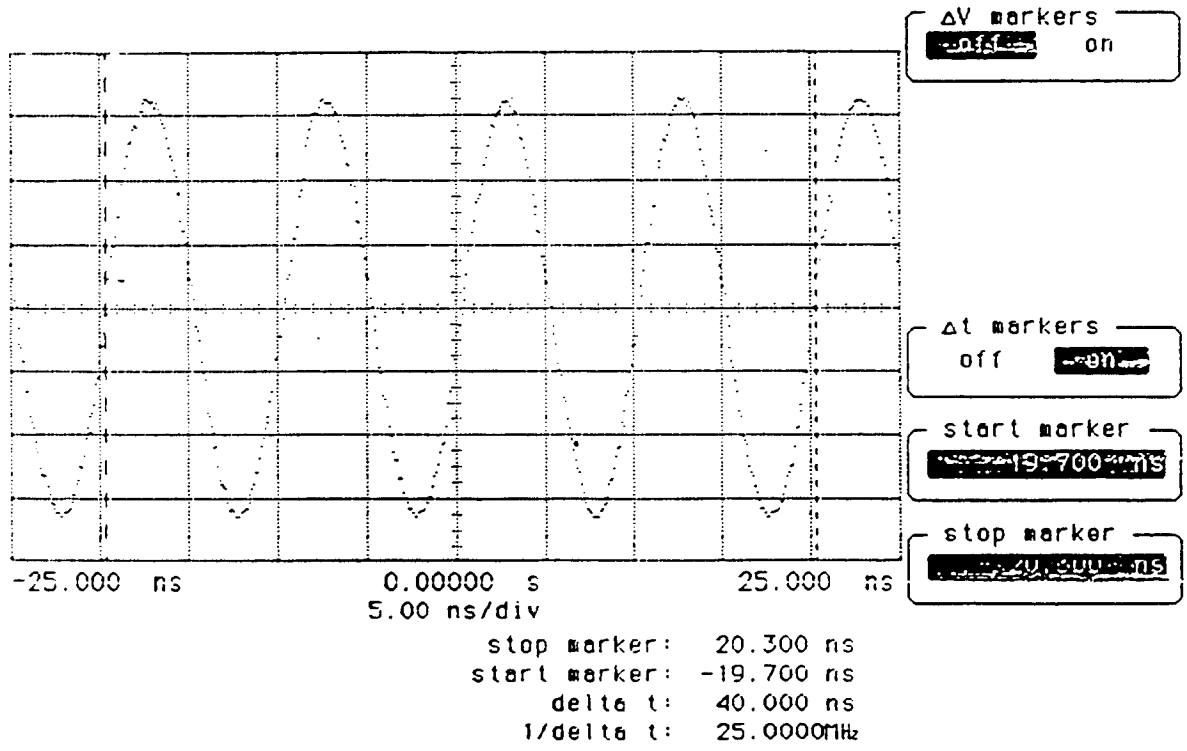

Figure 3-2. Delta-t Accuracy Test Result

### 3-9. VOLTAGE MEASUREMENT ACCURACY TEST

**Specification:**

Single Cursor = Gain Accuracy + Offset Accuracy + A/D resolution

Dual Cursor (single channel) = Gain Accuracy + 2 X A/D resolution

**Equipment Required:**

Power Supply ..... HP 6114A  
 BNC 50-ohm Adapter ..... HP 1251-2277  
 BNC Cable ..... HP 10503A

**Procedure:**

1. Connect Power Supply to HP 54501A Channel 1 input via BNC 50-ohm adapter.
2. Set DISPLAY menu # of avg for 2048.
3. Set HP 54501A CHANNEL menu V/div, offset, and Power Supply output to values in table 3-1.
4. Results should be as in table 3-1.
5. Repeat steps 1 through 4 for Channel 4.
6. Repeat steps 1 through 4 for Channels 2 and 3 on 500 mV, 200 mV, and 100 mV ranges.

*Table 3-1. Voltage Measurement Accuracy Test Values and Results*

V/div Setting	Offset Setting	Power Supply	Tolerance +/-	Minimum V	Maximum V
5 V	+15 V	30 V	2.06 V	27.94 V	32.06V
2 V	+6 V	12 V	824 mV	11.18 V	12.82 V
1 V	+3 V	6 V	412 mV	5.58 V	6.41 V
500 mV	+1.5 V	3 V	206 mV	2.79 V	3.21 V
200 mV	+600 mV	1.2 V	82.4 mV	1.12 V	1.28 V
100 mV	+300 mV	600 mV	41.2 mV	559 mV	642 mV
50 mV	+150 mV	300 mV	20.6 mV	279 mV	321 mV
20 mV	+60 mV	120 mV	8.2 mV	111.8 mV	128 mV
10 mV	+30 mV	60 mV	4.1 mV	55.9 mV	64 mV
5 mV	+15 mV	30 mV	2.2 mV*	27.8 mV	32.2 mV

\* A/D resolution changes from 0.4% to 0.8% on 5 mV range.

Table 3-2. HP 54501A Performance Test Record

Hewlett-Packard Model 54501A 100 MHz Digitizing Oscilloscope  Serial No. _____	Tested by _____ Work Order No. _____ Date Tested _____
Recommended Calibration Interval <u>12</u> Months	

Para No	Test	Test Limit	Results			
3-5	BANDWIDTH	<3 dB @ 100 MHz >5.6 div of deflection	CH1	CH2	CH3	CH4
			—	—	—	—
3-6	OFFSET ACCURACY	< 1.8 div < 0.4 div (5mV range)	—	—	—	—
3-7	TRIGGER SENSITIVITY	5 mV @10 MHz    0.8 div 5 mV @50 MHz    2 div 200 mV @10 MHz  0.4 div 200 mV @50 MHz   1 div	—	—	—	—
3-8	DELTA-T ACCURACY	40 nsec ± 1.3 nsec (38.7 to 41.3 nsec)	—			
3-9	VOLTAGE MEASUREMENT ACCURACY	V/div    Offset	Minimum	CH1	CH4	Maximum
		5 V    +15 V	27.94 V	—	—	32.06 V
		2 V    +6 V	11.18 V	—	—	12.82 V
		1 V    +3 V	5.58 V	—	—	6.41 V
		500 mV    +1.5 V	2.79 V	—	—	3.21 V
		200 mV    +600 mV	1.12 V	—	—	1.28 V
		100 mV    +300 mV	559 mV	—	—	641 mV
		50 mV    +150 mV	279 mV	—	—	321 mV
		20 mV    +60 mV	111.8 mV	—	—	128 mV
		10 mV    +30 mV	55.9 mV	—	—	64 mV
		5 mV    +15 mV	27.8 mV	—	—	32.2 mV
			CH2 CH3			
		500 mV    +1.5 V	2.79 V	—	—	3.21 V
		200 mV    +600 mV	1.12 V	—	—	1.28 V
		100 mV    +150 mV	559 mV	—	—	641 mV



## SECTION 4. ADJUSTMENTS

### Table of Contents

4-1.	Introduction .....	4-1
4-2.	Equipment Required .....	4-1
4-3.	Calibration Interval .....	4-1
4-4.	HP 54501A Self Calibration .....	4-1
4-5.	Power Supply Adjustment .....	4-2
4-6.	CRT Monitor Assembly Adjustments .....	4-3
4-7.	Intensity, Sub-bright, and Contrast Adjustments .....	4-3
4-8.	Focus Adjustment .....	4-5
4-9.	Horizontal Phase, Vertical Linearity, and Height Adjustments .....	4-5
4-10.	System Board Assembly Adjustments .....	4-6
4-11.	Extender Cable Installation .....	4-6
4-12.	Default Calibration Load .....	4-6
4-13.	DAC Reference Adjustment.....	4-7
4-14.	Track and Hold Offset Adjustments .....	4-9
4-15.	Attenuator Compensation Adjustments .....	4-10
4-16.	Pulse Response.....	4-11
4-17.	Self Calibration.....	4-12
4-18.	Logic Trigger Delay Calibration.....	4-13
4-19.	Oscillator Output Check.....	4-14





## SECTION 4

# ADJUSTMENTS

### 4-1. INTRODUCTION

This section provides adjustment and self calibration procedures for the HP 54501A. The assemblies with adjustments are: the power supply, CRT monitor, and the system board. Figures 4-1 and 4-2 are the testpoint and adjustment locations for the HP 54501A.

### 4-2. EQUIPMENT REQUIRED

Equipment required for adjustments is listed in the Recommended Test Equipment table in section 1 of this manual. Any equipment that satisfies the critical specification listed in the table may be substituted for the recommended model.

### 4-3. CALIBRATION INTERVAL

The recommended calibration interval for the HP 54501A is 2000 hours of operation (or two years, whichever comes first). The adjustments are set at the factory on assemblies when they are tested. However, adjustments may be necessary after repairs have been made to the instrument. Usually the only assembly that may require adjustments is the assembly that has been replaced.

### 4-4. HP 54501A SELF CALIBRATION

The HP 54501A has self-contained calibration procedures that are executed after manual adjustments have been made to the System Board Assembly. The self-calibration routines execute automatic A/D, gain, offset, trigger, and delay calibration and store the resulting factors to non-volatile memory.

Default values from system ROM are loaded to non-volatile memory as a starting reference before beginning adjustments on the System Board Assembly.

When power is applied to the HP 54501A and the message **cal ram checksum error re-cal instrument** is displayed, the self calibration procedures must be performed. Load the default cal factors as instructed in paragraph 4-12, and then perform the self calibration in paragraph 4-17.

If the instrument does not pass the self calibration, perform all of the adjustment procedures in this section. If the adjustments cannot be made within the specified limits, one or more of the replaceable modules must be replaced.

### NOTE

*An instrument warm-up of 15 minutes is recommended before adjustment procedures are performed.*

### WARNING

*Read the Safety Summary at the beginning of this manual before performing any adjustment procedures.*

### CAUTION

*The adjustment procedures are performed with the top cover of the instrument removed. Take care to avoid shorting or damaging internal parts of the instrument.*

### 4-5. POWER SUPPLY ASSEMBLY ADJUSTMENT

#### Required Equipment

Power Supply .....	HP 6114A
Digital Multimeter.....	HP 3478A

1. Disconnect power cord from HP 54501A. Refer to figure 4-1 for testpoint and adjustment locations.
2. Connect the common lead of the voltmeter to Power Supply Assembly chassis.
3. Connect the positive lead of the voltmeter to +5.15V on the Power Supply Assembly.
4. Connect the power cord to the HP 54501A and put power switch in ON position.
5. Voltmeter should indicate voltage within the range of +5.150 V to +5.175 V and not to exceed upper limit of 5.2 V.
6. If voltmeter reading is out of this range, adjust +5 ADJ on Power Supply Assembly to +5.150 V  $\pm$  .050 V (+5.125 V to +5.175 V).

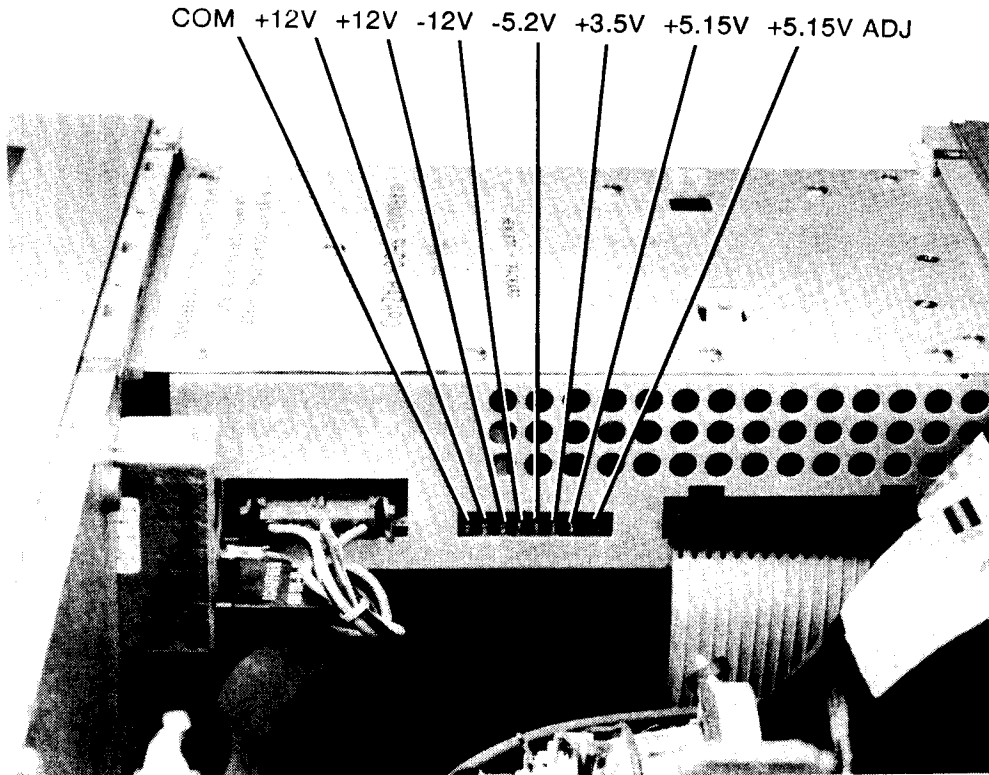

Figure 4-1. HP 54501A Power Supply Assembly Testpoints and Adjustment Location

## 4-6. CRT MONITOR ASSEMBLY ADJUSTMENTS

### No Equipment Required

#### NOTE

All CRT Monitor Assembly adjustments are preset at factory and should not need readjustment. These adjustment procedures should be performed only when the display has obvious differences from CRT test display in figure 4-2.

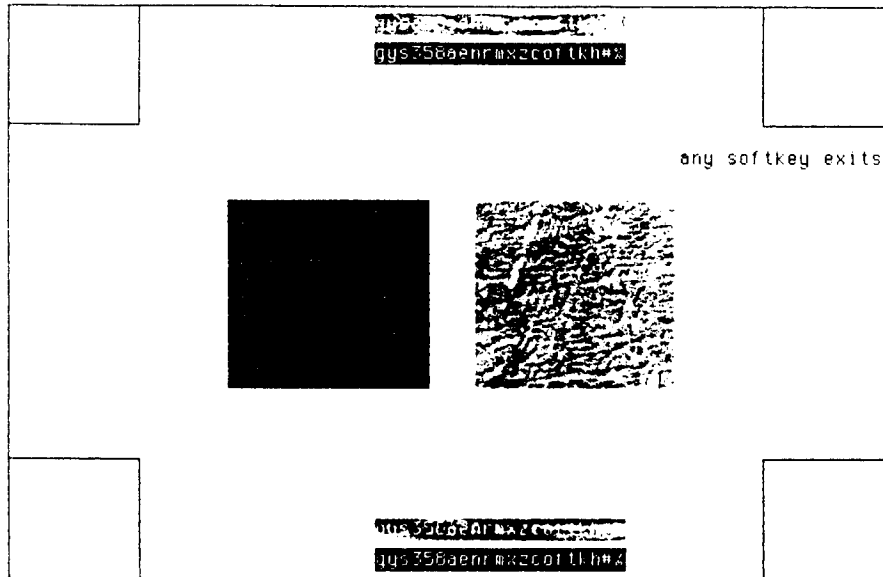
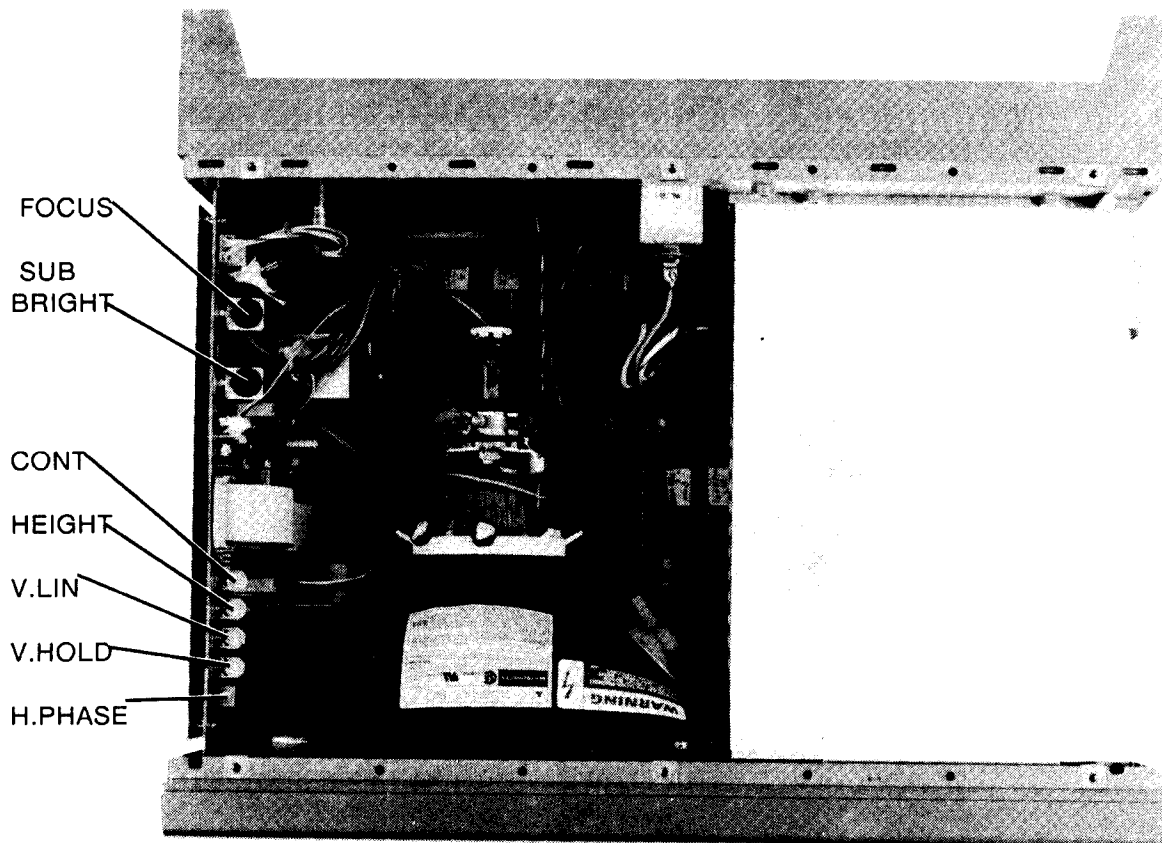

Figure 4-2. HP 54501A CRT Test Display

1. Place CRT test menu on HP 54501A screen for the CRT Assembly adjustments via the UTILITY menu. Use this test menu for all CRT adjustments.
  - a. Invoke the **UTILITY MENU** by pressing the front-panel UTIL key.
  - b. By using the softkeys located vertically along the display select, in sequence, **selftest menu**, **misc**, and then **crt test**.
  - c. Press **start test** to place crt test menu on the display.
2. Refer to figure 4-3 for CRT adjustment locations.
3. Adjust sweep board V.HOLD (vertical hold) adjustment, if necessary, for vertical synchronization.



*Figure 4-3. Adjustment Locations of HP 54501A CRT Monitor Assembly*

#### **4-7. Intensity, Sub-bright, and Contrast Adjustment**

1. Set rear-panel INTENSITY to the mid-range setting.
2. Adjust sweep board SUB-BRIGHT control to the lowest setting of brightness where lower-intensity blocks on menu are visible on the CRT screen.
3. Turn rear-panel INTENSITY to bring up the intensity level on screen. Screen intensity should be at a comfortable viewing level and the position of adjustment should be close to three-quarter range.
4. Adjust CONT for the best contrast between low- and high-intensity blocks on menu ensuring text is legible in low-intensity blocks.

#### 4-8. Focus Adjustment and Horizontal Phase Adjustments

1. Adjust sweep board H. PHASE to center menu horizontally on the CRT screen.
2. Adjust sweep board FOCUS control for sharp percent symbol (%) on the top and bottom blocks of text.

#### 4-9. Vertical Linearity and Height Adjustments

1. Adjust sweep board V. LIN for equal height of corner squares. Square height should be approximately 25 mm.

#### NOTE

*The V. LIN and HEIGHT adjustments are interactive and may need to be repeated as necessary.*

2. Adjust sweep board HEIGHT to give the screen menu top and bottom borders equal to approximately 1 cm.
3. Readjust steps 1 and 2 as necessary for a uniform display of the screen menu.

## 4-10. SYSTEM BOARD ASSEMBLY ADJUSTMENTS

### 4-11. Extender Cable Installation

#### Equipment Required:

Extender Cable..... HP 54503-61604

#### NOTE

*Use an external fan on the power supply to prevent the possibility of thermal cut-out of the power supply.*

#### Procedure:

1. Remove power from HP 54501A.
2. Remove top cover.
3. Disconnect power supply cables from line filter and System Board Assembly.
4. Remove locking pins from power supply.
5. Slide power supply out from side of HP 54501A.
6. Connect the Extender Cable from power supply to System Board Assembly.
7. Reconnect line filter cable to power supply.
8. Connect power cable and apply power.

### 4-12. Default Calibration Load

#### No Equipment Required

1. Invoke **SERVICE MENU** by first pressing front-panel UTIL key and then selecting **service menu**.
2. Select **cal select 3** with menu softkey.
3. Set rear panel CALIBRATION switch to UNPROTECTED position.
4. Press **start cal** menu softkey. A caution message will be displayed indicating the cal RAM will be overwritten with default values.
5. Press **continue** softkey.
6. The status message at the top of the menu will indicate default cal has been loaded.
7. Leave rear panel switch in UNPROTECTED position for self calibration procedure that is performed later in this section.

### 4-13. DAC Reference Adjustment

**Equipment Required:**

Digital Multimeter (DVM) ..... HP 3478A

**Procedure:**

1. Invoke **SERVICE MENU** by first pressing front-panel UTIL key and then selecting **service menu**.
2. Select **cal select 2** with menu softkey.
3. Set **dac output** to **high adjust**.
4. Connect DVM to rear panel DC Calibrator Output.
5. Adjust System Board Assembly R723 for DVM indication of 5.0000 V. Refer to figure 4-4 for adjustment location.
6. Set **cal select** to **low view**.
7. Measure V1 to four decimal places, 0.\_\_\_\_\_ volts.
8. Set **dac output** to **high adjust**.
9. Adjust System Board Assembly R723 for DVM indication of 5.000V PLUS V1 from step 7.
10. Select **exit menu** softkey and oscilloscope will return to **Utility menu**.

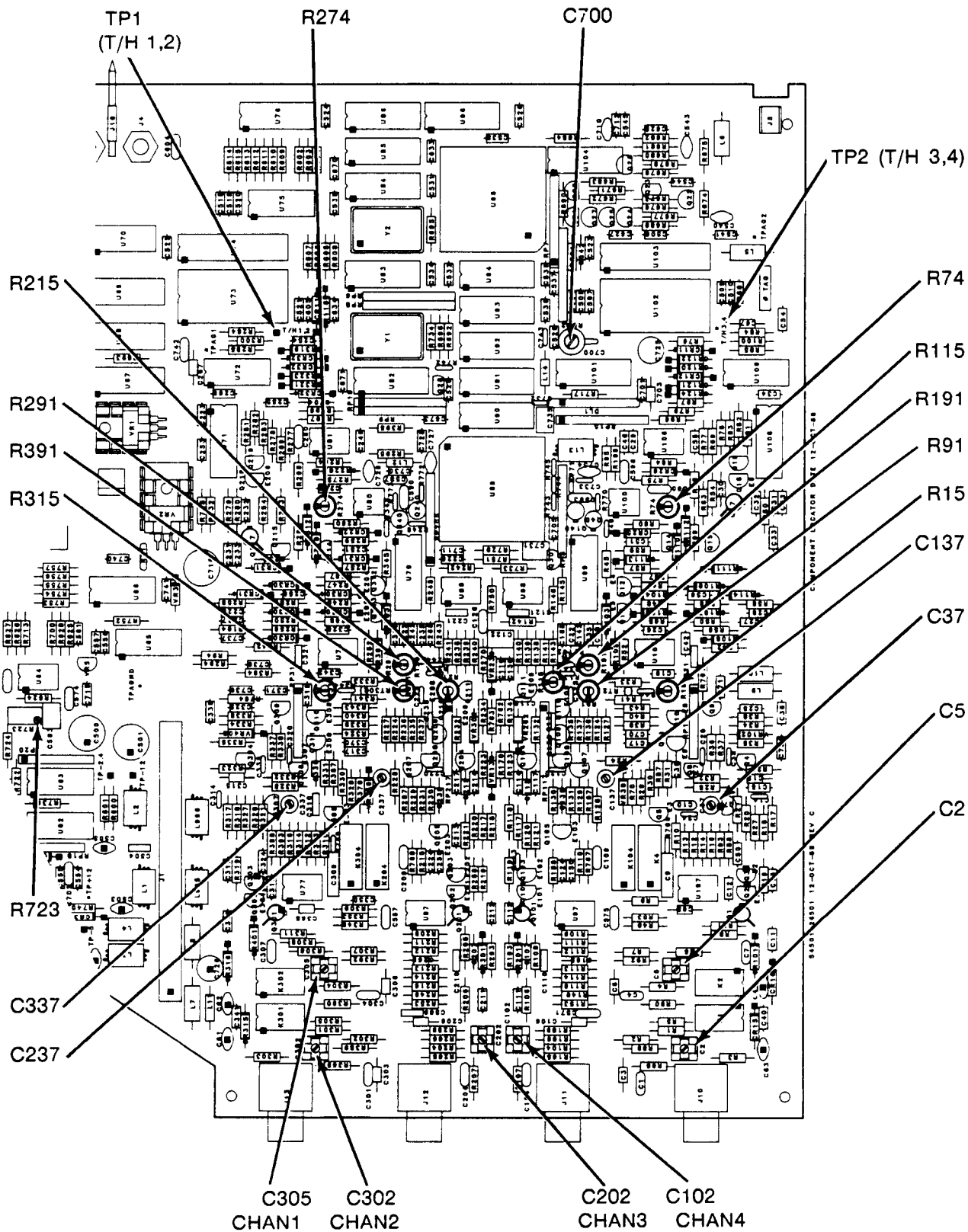

Figure 4-4. HP 54501A System Board Assembly Component Locator



## 4-14. Track and Hold Offset Adjustments

### Equipment Required:

100 MHz Oscilloscope ..... HP 54501A  
High Impedance 10:1 Divider Probe..... HP 10432A

### Procedure:

1. Press **CHAN** key and set **CHANNEL** menu for the following parameters:
  - a. Channels 1 and 4 **on**.
  - b. Channels 2 and 3 **off**.
  - c. Vertical sensitivity of channels 1 and 4 to **100 mV/div**.
  - d. **Offset** for trace at center screen.
2. Connect oscilloscope probe to System Board Assembly TP1 (T/H 1,2) Refer to figure 4-4 for location of testpoints.
3. Adjust System Board Assembly R274 until the 10 MHz square wave of Channel 1 is at minimum amplitude. Do not adjust R274 to the end-range position.
4. Connect oscilloscope probe to System Board Assembly TP2 (T/H 3,4).
5. Adjust System Board Assembly R74 until the signal on Channel 4 is at minimum amplitude.

## 4-15. Attenuator Compensation Adjustments

### Equipment Required:

Square Wave Generator.....	HP 8116A
50 Ohm Termination .....	HP 10100C
BNC Cable .....	HP 10503A

### Procedure:

1. Connect Square Wave Generator to HP 54501A Channel 1 input, using the 50-ohm termination and BNC cable.
2. Set Square Wave Generator for output of 100 Hz with approximately 300 mVp-p amplitude.
3. AUTOSCALE and then set channel 1 vertical sensitivity to **50mV/div**.
4. Adjust System Board Assembly R315 for displayed signal with flat top and baseline. Refer to figure 4-4 for adjustment location.
5. Connect Square Wave Generator to HP 54501A Channel 4. AUTOSCALE.
6. AUTOSCALE and set channel 4 vertical sensitivity to **50mV/div**.
7. Adjust System Board Assembly R15 for flat top and baseline on displayed signal.
8. Connect Square Wave Generator to Channel 2 and increase output to approximately 1 V p-p.
9. AUTOSCALE and set channel 2 vertical sensitivity to **200 mV/div**.
10. Adjust System Board Assembly R215 for flat top and baseline on displayed signal.
11. Connect Square Wave Generator to Channel 3.
12. AUTOSCALE and set channel 3 vertical sensitivity to **200 mV/div**.
13. Adjust System Board Assembly R115 for flat top and baseline on displayed signal.
14. Connect Square Wave Generator to Channel 1. AUTOSCALE.
15. AUTOSCALE and set channel 1 vertical sensitivity to **200 mV/div**.
16. Adjust System Board Assembly C305 for flat top and baseline on displayed signal.
17. Connect Square Wave Generator output to Channel 2.
18. AUTOSCALE and set channel 2 vertical sensitivity to **200 mV.div**.
19. Adjust System Board Assembly C202 for flat top and baseline on displayed signal.
20. Connect Square Wave Generator to Channel 3.

21. AUTOSCALE and set channel 3 vertical sensitivity to **200 mV/div**.
22. Adjust System Board Assembly C102 for flat top and baseline on displayed signal.
23. Connect Square Wave Generator to Channel 4.
24. AUTOSCALE and set channel 4 vertical sensitivity to **200 mV/div**.
25. Adjust System Board Assembly C5 for flat top and baseline on displayed signal.
26. Change Square Wave Generator output for approximately 5 Vp-p output.
27. AUTOSCALE and set channel 4 vertical sensitivity to **2 V/div**.
28. Adjust System Board Assembly C2 for flat top and baseline on displayed signal.
29. Connect Square Wave Generator output to Channel 1. AUTOSCALE.
30. AUTOSCALE and set channel 1 vertical sensitivity to **2 V/div**.
31. Adjust System Board Assembly C302 for flat top and baseline on displayed signal.

#### 4-16. Pulse Response Adjustments

##### Equipment Required:

Pulse Generator ..... Tektronix 284  
 50 Ohm Termination ..... HP 10100C

##### Procedure:

1. Connect Pulse Generator to HP 54501A Channel 1 input using 50-ohm termination.
2. Set Pulse Generator for output amplitude of 200 mV.
3. AUTOSCALE.
4. Press TIMEBASE and set for **5 nsec/div**.
5. Adjust System Board Assembly C337 and R391 for a leading edge overshoot of not more than 4%.
6. Repeat same procedure on Channels 2, 3, and 4 adjusting System Board Assembly C237 and R291, C137 and R191, and C37 and R91 respectively.

## 4-17. Self Calibration

### Equipment Required:

BNC Cable ..... HP 10503A

### Procedure:

#### NOTE

*Rear panel CALIBRATION switch must be in UNPROTECTED position for this procedure. If entire adjustment procedures are being performed, switch was set to UNPROTECTED position in previous procedure.*

1. Perform keydown powerup by cycling HP 54501A power while holding down any front-panel key.
2. Select UTILITY menu by pressing front-panel UTIL key.
3. Select **self cal menu** with menu softkey and SELF CAL MENU will be displayed.
4. Select **cal select 0** to perform the vertical self calibration.

#### NOTE

*Perform vertical calibration on all channels at one time with BNC tees and connectors or one at a time in the channel order of: 1, 4, 2, then 3.*

5. Select **start cal** with menu softkey and messages will be displayed to complete calibration. Vertical calibration takes approximately 7 minutes to complete.
6. Connect the BNC cable to the next channel to be calibrated and repeat step 4 until all channels have been calibrated.
7. Select **cal select 1** to perform the delay calibration on each channel.
8. Messages will be displayed as each calibration routine is completed to indicate calibration has passed.

## 4-18. Logic Trigger Delay Calibration

### Equipment Required:

BNC Cable ..... HP 10503A

### Procedure:

1. Invoke **SERVICE MENU** by first pressing front-panel UTIL key and then selecting **service menu**.
2. Select **cal select 0** with menu softkey.
3. Connect BNC cable from rear panel AC Calibrator Output to channel 1 input.
4. Select **start cal** menu softkey.
5. Select **continue**.
6. Adjust System Board Assembly C700 if \* is on either side of brackets in message at bottom of screen.
7. When [\*], press **continue**.
8. When logic trigger delay cal has been successfully completed, **PASSED** message will be displayed.
9. Switch rear-panel CALIBRATION switch to PROTECTED position.

#### 4-19. Oscillator Output Check (Optional)

**Equipment Required:**

Oscilloscope..... HP 54501A

**Procedure:**

1. Connect HP 54501A rear panel AC Calibrator Output to oscilloscope.
2. AC compensation signal is 1.50588 kHz.
3. Invoke **SERVICE MENU** by first pressing front-panel UTIL key and then selecting **service menu**.
4. Select **cal select 1** with menu softkey.
5. Select **processor clock** with menu softkey.
6. Processor clock of 19.6608 MHz is at rear-panel AC Calibrator output.
7. Select **timebase clk** with menu softkey.
8. Timebase clock of 10.1808 MHz is at rear-panel AC Calibrator output.

## SECTION 5. REPLACEABLE PARTS

### Table of Contents

5-1.	Introduction .....	5-1
5-2.	Abbreviations .....	5-1
5-3.	Replaceable Parts .....	5-1
5-4.	Exchange Assemblies .....	5-1
5-5.	Ordering Information .....	5-1
5-6.	Direct Mail Order System .....	5-1





## SECTION 5

# REPLACEABLE PARTS

### 5-1. INTRODUCTION

This section contains information for ordering parts. Table 5-1 lists the abbreviations used in the parts list and throughout the manual. Table 5-2 lists all replaceable parts for the instrument. Table 5-3 contains the names and addresses corresponding to the code number of the manufacturer. Figure 5-1 is the exploded view of the HP 54501A.

### 5-2. ABBREVIATIONS

Table 5-1 lists the abbreviations used in the parts list, the schematics, and elsewhere in this manual. In some cases two forms of the abbreviations are used, one in all capital letters, and one in partial or no capital letters. However, elsewhere in the manual, other abbreviation forms may be used with both lower-case and uppercase letters.

### 5-3. REPLACEABLE PARTS

Table 5-2 is a list of replaceable parts and is organized as follows:

- a. Electrical assemblies in alphanumerical order by reference designation.
- b. Chassis-mounted parts in alphanumerical order by reference designation.
- c. Electrical assemblies and their components in alphanumerical order by reference designation.

The information given for each part consists of the following:

- a. Reference designation.
- b. Hewlett-Packard part number.
- c. Part number Check Digit (CD).
- d. Total quantity (QTY) in instrument or on assembly. The total quantity is given once and at the first appearance of the part number in the list.
- e. Description of the part.
- f. Typical manufacturer of part in an identifying five-digit code.

### 5-4. EXCHANGE ASSEMBLIES

Some parts used in this instrument have been set up for an exchange program. This program allows the customer to exchange his faulty assembly with one that has been repaired, calibrated, and performance-verified by the factory. The cost is significantly less than that of a new part. The exchange parts have a part number in the form XXXXX-695XX.

After receiving the repaired exchange part from Hewlett-Packard, a United States customer has 30 days to return the faulty assembly. For orders not originating in the United States, contact the local Hewlett-Packard service organization. If the faulty assembly is not returned within the warranty time limit, the customer will be charged an additional amount. The additional amount will be the difference in price between a new assembly and that of an exchange assembly.

### 5-5. ORDERING INFORMATION

To order a part in the material list, quote the Hewlett-Packard part number, indicate the quantity desired, and address the order to the nearest Hewlett-Packard Sales/Service Office.

To order a part not listed in the material list, include the instrument part number, instrument serial number, a description of the part (including its function), and the number of parts required. Address the order to the nearest Hewlett-Packard Sales and Service Office.

### 5-6. DIRECT MAIL ORDER SYSTEM

Within the USA, Hewlett-Packard can supply parts through a direct mail order system. There are several advantages to this system:

- a. Direct ordering and shipment from the Hewlett-Packard Parts Center in Mountain View, California.

- b. No maximum or minimum on any mail order (there is a minimum amount for parts ordered through a local Hewlett-Packard office when the orders require billing and invoicing).
- c. Prepaid transportation (there is a small handling charge for each order).
- d. No invoices.

In order for Hewlett-Packard to provide these advantages, a check or money order must accompany each order.

Mail order forms and specific ordering information are available through your local Hewlett-Packard office. Addresses and telephone numbers are located at the back of this manual.

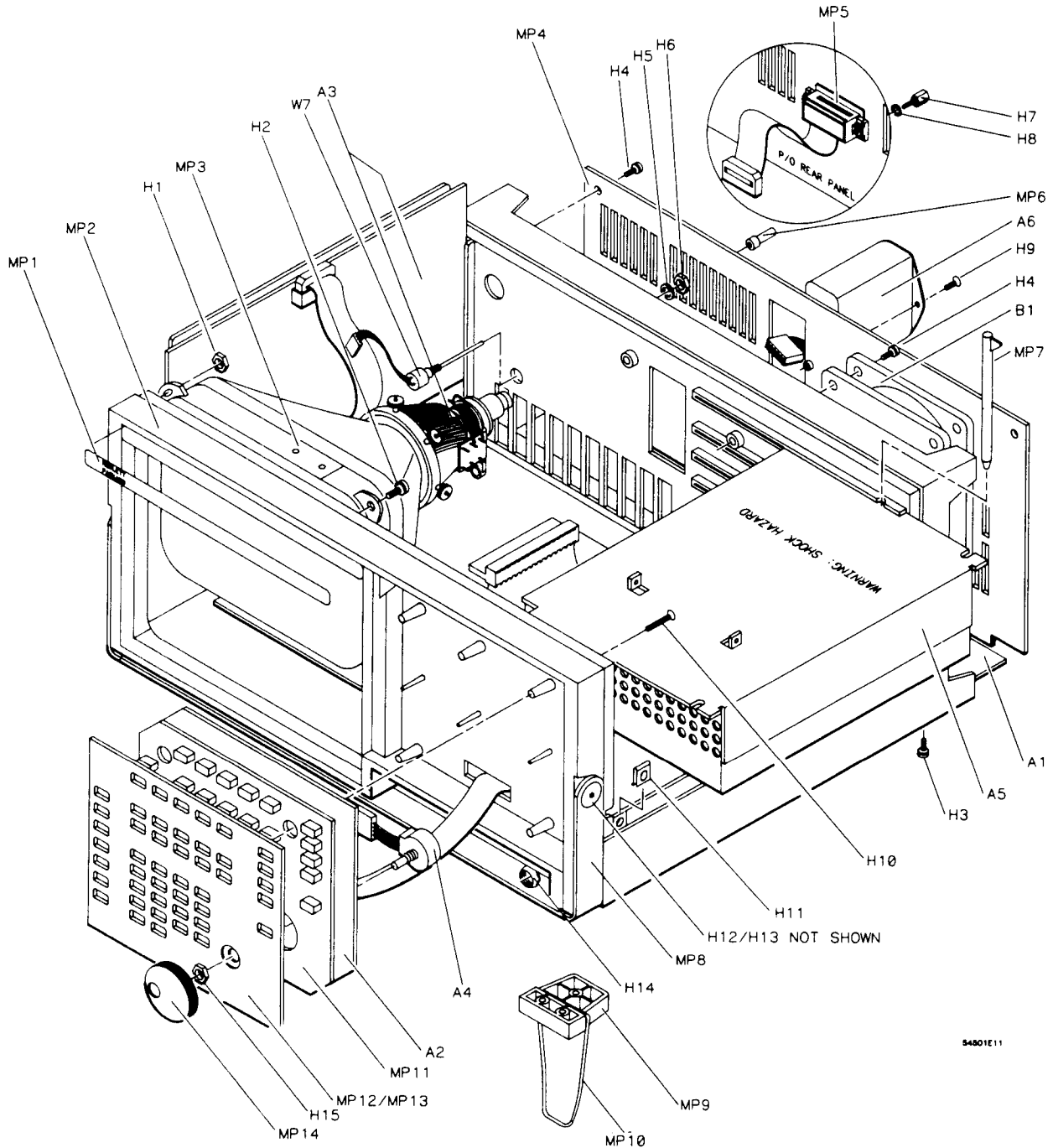

Figure 5-1. HP 54501A Exploded View

Table 6-2. Replaceable Parts (Cont'd)

Reference Designator	HP Part Number	C D	Qty	Description	Mfr Code	Mfr Part Number
A1	54501-89501	9	1	PROCESSOR BOARD ASSEMBLY	28480	54501-89501
A2	54503-86502	8	1	KEYBOARD ASSEMBLY	28480	54503-86502
A3	2090-0211	6	1	CRT MONITOR ASSEMBLY	28480	2090-0211
A4	0960-0753	6	1	ROTARY PULSE GENERATOR ASSEMBLY	28480	0960-0753
A5	0950-1879	8	1	POWER SUPPLY ASSEMBLY	28480	0950-1879
A6	9135-0325	8	1	LINE FILTER/SWITCH ASSEMBLY	28480	9135-0325
H1	0535-0056	3	3	LOCKNUT HEX (CRT)	28480	0535-0056
H2	0515-0380	2	1	MS M4X0.7X10 (CRT)	28480	0515-94303
H3	0590-1805	6	6	INSERT-THREADED (CRT)	28480	0590-1805
H4	0515-0374	5	20	MSPH M3X10MM (FAN/REAR PANEL/BOTTOM)	28480	0515-0374
H5	2190-0027	6	1	WASHER 256 .478 .02 (INT ADJ)	28480	2190-0027
H6	2950-0072	3	1	NUTH 1/4-32X.062 (INT ADJ)	28480	2950-0072
H7	0380-1482	0	2	STANDOFF-HEX (HP-IB CONNECTOR)	28480	0380-1482
H8	2190-0009	4	2	WIL .168 .34.02 (HP-IB CONNECTOR)	28480	2190-0009
H9	0515-1035	0	22	MSFH M3X8MM (FEET/COVER/POUCH/FILTER)	28480	0515-1035
H10	0515-1134	7	4	MSFH M3X25MM (KEYBOARD)	28480	0515-1134
H11	0535-0113	8	10	TINNERMAN NUT (CABINET TOP AND SIDES)	28480	0535-0113
H12	01650-82401	1	2	SCREW SHOULDER (HANDLE)	28480	01650-82401
H13	01650-00203	0	2	NUT PLATE (HANDLE)	28480	01650-00203
H14	54503-25701	7	4	NUT-HEX (FRONT PANEL BNCS)	28480	54503-25701
H15	2950-0001	8	1	NUTH 1/4-32X.093 (RPG)	28480	2950-0001
B1	3160-0521	3	1	FAN-TUBEAXIAL	28480	3160-0521
F1	2110-0003	0	1	FUSE 3 AMP	28480	2110-0003
MP1	54501-94304	2	1	LABEL - HP 54501A IDENTIFICATION	28480	54501-94304
MP2	54503-45201	4	1	CABINET-MOLDED	28480	54503-45201
MP3	01650-01202	0	1	BRACKET-GROUND	28480	01650-01202
MP4	54503-00201	0	1	REAR PANEL	28480	54503-00201
MP5	54503-61602	3	1	CONNECTOR/HP-IB	28480	54503-61602
MP6	5040-8823	2	1	KNOB-GRAY (INT-REAR PANEL)	28480	5040-8823
MP7	01650-46101	2	2	LOCKING PIN (PC BOARD)	28480	01650-46101
MP8	01650-04901	2	1	HANDLE-BALE	28480	01650-04901
MP9	01650-47701	0	2	FOOT-MOLDED	28480	01650-47701
MP10	1460-1345	5	2	TILT STAND	28480	1460-1345
MP11	54503-41901	3	1	KEYPAD-ELASTOMERIC	28480	54503-41901
MP12	54503-45202	5	1	PANEL-KEYBOARD	28480	54503-45202
MP13	54503-94302	9	1	LABEL KEYBOARD	28480	54503-94302
MP14	01650-47401	7	1	KNOB-RPG	28480	01650-47401
MP15	5080-2054	3	1	LABEL-CSA CERTIFICATION	28480	5080-2054
MP16	01650-04101	4	1	COVER-TOP	28480	01650-04101
MP17	01650-84501	7	1	POUCH-TOP COVER (ACCESSORY)	28480	01650-84501
MP18	54501-94305	8	1	LABEL OVERLAY-FRONT PANEL BNCS	28480	54501-94305
MP19	54501-00603	5	1	BOTTOM SHIELD-ATTENUATORS	28480	54501-00603
W1	54503-61603	4	1	CABLE-DC POWER SUPPLY ASSEMBLY	28480	54503-61603
W2	54503-61605	6	1	CABLE-AC CALIBRATOR OUTPUT 50 OHMS	28480	54503-61605
W3	54503-61605	3	1	CABLE-DC CALIBRATOR OUTPUT 50 OHMS	28480	54503-61605
W4	54503-61602	3	1	CABLE-HP-IB CONNECTOR	28480	54503-61602
W5				CABLE-KEYBOARD ASSEMBLY	28480	
W6	01650-61601	9	1	CABLE-CRT MONITOR ASSEMBLY	28480	01650-61601
W7	01650-61606	4	1	CABLE/INTENSITY ADJUST	28480	01650-61606
W8	01650-61602	0	1	CABLE-LINE FILTER	28480	01650-61602
W9	8120-1521	6	1	CABLE-POWER (STANDARD INSTRUMENT)	28480	8120-1521
W9	8120-1703	6	1	CABLE-POWER (OPTION 900-UK)	28480	8120-1703
W9	8120-0696	4	1	CABLE-POWER (OPTION 901-AUSTL)	28480	8120-0696
W9	8120-1692	2	1	CABLE-POWER (OPTION 902-EUR)	28480	8120-1692
W9	8120-2296	4	1	CABLE-POWER (OPTION 906-SWIT)	28480	8120-2296
W9	8120-2957	4	1	CABLE-POWER (OPTION 912-DEN)	28480	8120-2957
W9	8120-4600	8	1	CABLE-POWER (OPTION 917-AFRICA)	28480	8120-4600
W9	8120-4754	3	1	CABLE-POWER (OPTION 918-JAPAN)	28480	8120-4754
W10	54503-61604	5	1	CABLE-SERVICE EXTENDER	28480	54503-61604
P1	54503-87601	6	1	PLUG-BANANA	28480	54503-87601

See introduction to this section for ordering information



## SECTION 6. SERVICE

### Table of Contents

6-1.	Introduction .....	6-1
6-2.	Safety Considerations.....	6-1
6-3.	Logic Convention .....	6-1
6-4.	Block Level Theory of Operation .....	6-2
6-5.	Power Supply Assembly.....	6-2
6-6.	Display Monitor Assembly.....	6-2
6-7.	System Board Assembly .....	6-2
6-8.	Keyboard Assembly .....	6-2
6-9.	System Board Assembly Theory of Operation .....	6-4
6-10.	Data Acquisition.....	6-4
6-11.	System Control.....	6-7
6-12.	Troubleshooting .....	6-9
6-13.	Troubleshooting Flowcharts .....	6-9
6-14.	Power Supply Voltages Check .....	6-16
6-15.	CRT Monitor Signals Check .....	6-17
6-16.	Keyboard Signals Check.....	6-19
6-17.	Assembly Removal and Installation .....	6-21
6-18.	Removal and Replacement of Rear Panel Assembly.....	6-22
6-19.	Removal and Replacement of Power Supply Assembly.....	6-22
6-20.	Removal and Replacement of Keyboard Assembly .....	6-23
6-21.	Removal and Replacement of System Board Assembly .....	6-24
6-22.	Removal and Replacement CRT Monitor Assembly.....	6-25
6-23.	Removal and Replacement of Fan.....	6-26
6-24.	Removal and Replacement of Feet/Tilt Stand .....	6-26
6-25.	HP 54501A Self Tests .....	6-27



## SECTION 6

### SERVICE

#### 6-1. INTRODUCTION

This section provides troubleshooting, service, and repair information for the HP 54501A Digitizing Oscilloscope. Troubleshooting consists of flowcharts, self test descriptions and instructions for use, and signal level tables. The troubleshooting information is provided to isolate a faulty module. When a faulty module has been located, the disassembly/assembly procedures help direct replacement of the module.

#### 6-2. SAFETY CONSIDERATIONS

Read the Safety Summary at the front of this manual before servicing the instrument. Before performing any procedure, review it for cautions and warnings.

#### WARNING

*Maintenance should be performed by trained service personnel aware of the hazards involved (for example, fire and electric shock). When maintenance can be performed without power applied, the power should be removed from the instrument.*

#### 6-3. LOGIC CONVENTION

Where logic levels are used in this manual, certain conventions are used. Logic states are defined as follows:

- 0 False, negated, inactive, or unasserted state.
- 1 True, active, or asserted state.

Voltage levels representing logic states are as follows:

- LOW (L) The more negative of two voltage levels.
- HIGH (H) The more positive of two voltage levels.

Signals may be either HIGH true, or LOW true. The HP 54501A contains both TTL and ECL ICs. Worst case voltage levels for troubleshooting and signature analysis are as follows (IC data sheet specifications may be more accurate):

#### TTL VOLTAGE LEVELS

Level	Voltage
LOW	less than 0.8 V
HIGH	greater than 2.0 V

#### ECL VOLTAGE LEVELS

Level	Voltage
LOW	less than -1.50 V
HIGH	greater than -1.10 V

Because ECL inputs are pulled down inside the IC, an unconnected ECL input is low. ECL outputs may be tied together the same way as open-collector TTL outputs. Thus, they may be wire-ANDed or wire-ORed.

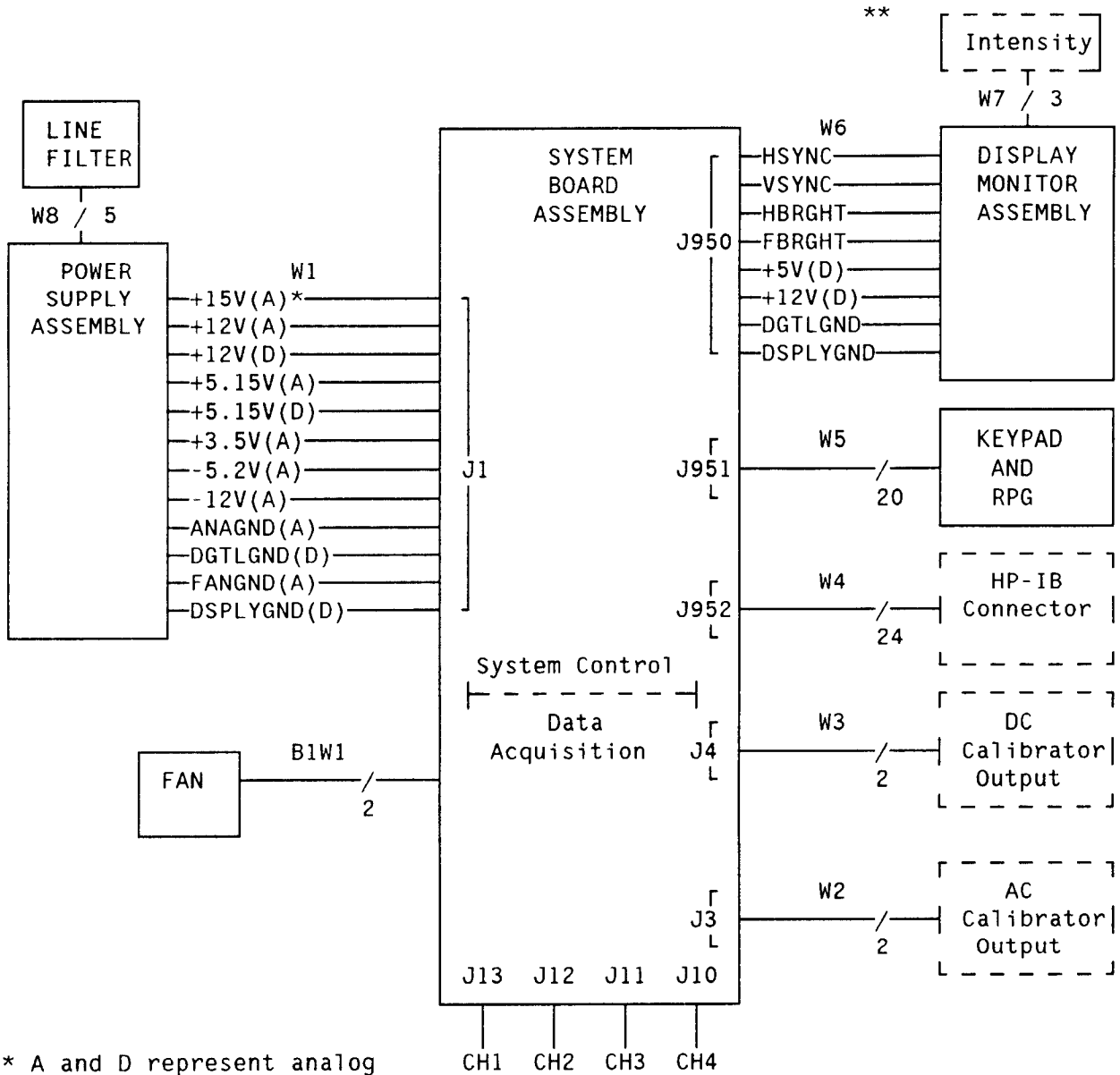

\* A and D represent analog and digital voltages from the power supply. Analog voltages are routed mainly to data acquisition section of the system board.

\*\* Dashed line indicates rear panel location.

Figure 6-1. HP 54501A Simplified Block Diagram



## 6-4. BLOCK LEVEL THEORY OF OPERATION

The HP Model 54501A is a four-channel 100 MHz digitizing oscilloscope. The human interface is a front-panel knob and keypad for instrument control and 9" (diagonal) green phosphor CRT for information display. Available on the rear panel is an HP-IB connector for communication to a printer or from a controller. Two oscilloscope outputs are also available on the rear panel through BNC connectors: one for dc calibration and one for ac calibration and probe compensation.

The hardware of the HP 54501A consists of four main modules. Figure 6-1 is a simplified block diagram of the four main assemblies. Also, in the diagram are rear panel connectors and the Intensity adjustment.

This manual supports troubleshooting to main assembly level. Theory of operation for the System Board Assembly is included for information only and is not intended for troubleshooting purposes.

### 6-5. Power Supply Assembly

The Power Supply Assembly of the HP 54501A is a 120 W switching power supply. It has a dc output power connector and cable that connects to the System Board Assembly. The ac input range to the power supply is 115V or 230 V and has maximum power of 200 W when operating at 48 - 66 Hz.

The Power Supply Assembly provides all voltages necessary to operate the HP 54501A to the System Board Assembly. Unfiltered voltages of +15V, -15V, +12V, -12V, +5.15V, and -5.2V are supplied to the board where they are then filtered and distributed throughout the board and to the Display Monitor Assembly. Filtered voltages of approximately +5 V and +12 V are routed through the System Board Assembly to the Display Monitor Assembly.

The +5.15 V supply is adjustable. The adjustment procedure is in section 4 of this manual.

### 6-6. Display Monitor Assembly

The Display Monitor Assembly consists of the sweep board circuitry, a 9-inch green phosphor display CRT, and the CRT yoke. The assembly requires +5 V and +12 V from the power supply via the System Board Assembly.

The CRT is a non-interlacing raster display controlled by the CPU portion of the System Board Assembly. System control provides synchronization and pixel information.

### 6-7. System Board Assembly

The System Board Assembly contains the acquisition system and system control circuitry. It also provides interfaces for the Power Supply Assembly, Display Monitor Assembly, keypad, RPG, and HP-IB. The input to the System Board Assembly from the target system is from any or all four channels located at the front panel BNCs. The user interface is from the front-panel keyboard or with a controller via the HP-IB connector located on the rear panel. A more detailed theory of the System Board Assembly follows this block level theory.

### 6-8. Keypad and Knob Assembly

The front-panel keypad of the HP 54501A is elastomeric and has 44 keys. Twenty of the keys are single-function, 17 are dual-function, and the remaining 7 are display softkeys with variable functions depending on the displayed menu. The keyboard rows are continually scanned at a frequency of 60 Hz and when a key is pressed, the signal is sent as data to the 68000 which determines the key pressed and its function.

The RPG (Rotary Pulse Generator) is controlled by the front-panel knob and supplies pulses to the 68000 microprocessor when the knob is turned. The RPG is used to dial in values for various settings of the displayed menu. The RPG will normally be set in coarse mode but may be used in fine mode by pressing the front-panel toggle key above the RPG labeled FINE.

## 6-9. SYSTEM BOARD ASSEMBLY THEORY OF OPERATION

The System Board Assembly is built around the 68000 microprocessor and acquisition circuitry that provide probing, shaping, storing, and analyzing of data from a target system. The system board block diagram has been divided into two sections: acquisition and system control. Figure 6-2 is the acquisition block diagram and figure 6-3 is the block diagram for system control.

### 6-10. Acquisition

The main blocks of the HP 54501A System Board Assembly acquisition consists of four input attenuators, four impedance converters and preamplifiers, two channel select circuits, two track and hold circuits, two post amplifiers, two A/D converters, two trigger comparators, logic trigger, timebase IC, fine interpolator, D/A converter, and acquisition RAM.

**Attenuators.** Channels 1 and 4 attenuators are divide by 1, 10, and 100 inputs and are fully programmable through 1/2/5 sequence levels over 2 mV/5 V/div (1 mV/div and 5 mV/div are software expands of the 10 mV/div setting). Channels 2 and 3 attenuators are divide by 10, non-programmable and display external triggers at 100 mV/div, 200 mV/div, and 500 mV/div.

The attenuators divide the incoming signal to a level the impedance converter and preamplifier can handle. Variable capacitors on the attenuators allow adjustment for stray capacitance.

**Impedance Converters and Preamplifiers.** The four impedance converters and preamplifiers of the HP 54501A are identical. When the signal reaches the impedance converter from the attenuator, it is split into its ac and dc components. This allows implementation of AC coupling to block the dc component from passing through. The impedance converter has an ac adjustment for pulse response.

The low-frequency component is applied to a low-frequency amplifier and the high-frequency component to a high-pass

filter. DC offset from the DAC is incorporated in the low-frequency amplifier. A variable resistor in the low-frequency amplifier is provided for compensation adjustments for each channel.

The high- and low-frequency components of the signal are recombined and applied to the input FET of the preamplifier providing a high input impedance for the preamplifier. The preamplifier changes the incoming signal into a differential signal (2 complementary signals) and adds a gain of X2.5 to one and X5 to the other. The edges of the outgoing signals represent the selected trigger point of the input signal. One of the signals goes to channel select, to be displayed on screen, and the other to the trigger comparator.

**Channel Select.** The channel select determines one of two channels to be digitized and displayed by the oscilloscope. There are two channel select circuits: one for channels 1 and 2 and one for channels 3 and 4. Thus, only two A/D converters are necessary for the four-channel oscilloscope. When both channels are selected for display, the two channels are sampled alternately so all four channels are displayed simultaneously.

**Track and Hold.** Track and hold limits the slew rate of the signal coming from channel select for the A/D converter. The adjustment in track and hold eliminates offset in the output of the circuit due to the switching between the two modes.

**Post Amplifier.** The post amplifier receives the signal from track and hold and divides it by 1, 2, or 5. These dividers are what differentiate the signals from the 10, 20, and 50 mV/div so that all signals are the same at the A/D converter. (The same is true for the 100, 200, and 500 mV/div and 1, 2, and 5 V/div ranges.) The signal is then amplified by 12 for an input of 2 V at the A/D converter for full scale on all ranges.

**A/D Converter.** The analog-to-digital converters digitize the signal into an 8-bit binary code that is then stored in the acquisition RAM. One A/D converter digitizes the signal from either channel 1 or 2 and the other the signal from channel 3 or 4, depending on Channel Select.

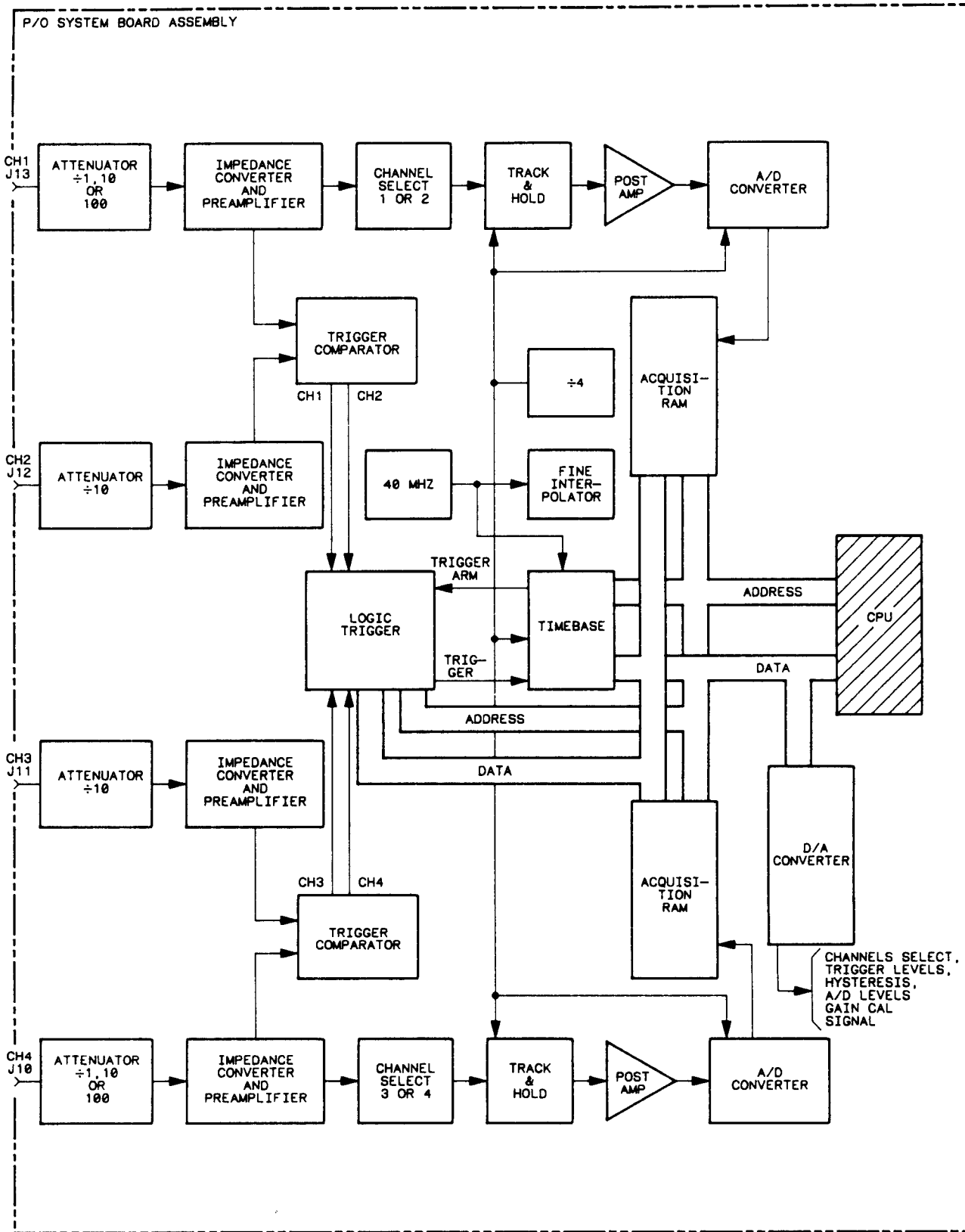

54501/BL 18

Figure 6-2. HP 54501A Acquisition Block Diagram

**Trigger Comparator.** The trigger comparator compares the input signal from the preamplifier with the trigger level signal from the DAC. The comparator also uses the trigger hysteresis from the DAC for partial noise immunity to the system. The incoming signal must be large enough to satisfy the hysteresis requirement before the output of the comparator switches. The output of the trigger comparator goes to the logic trigger.

**Logic Trigger.** The user trigger information is programmed to the logic trigger. The logic trigger accepts the outputs of all four trigger comparators and may be programmed for complex triggering on any one or all four channels.

**Timebase.** The timebase is the IC that provides the sample clock for all timing necessary for data acquisition. The clock for the timebase is a 40 MHz oscillator. The timebase uses the 40 MHz time and the 40 MHz divided by four (10 MHz). The timebase has programmable internal dividers for output frequencies of the sample clock appropriate for the time range the user has selected. The timebase receives the trigger timing information from the fine interpolator.

The timebase has counters to control how much data is taken before (pretrigger data) and after (posttrigger data) the trigger event. When the desired number of points for pretrigger data have occurred, the timebase sends a signal to the logic trigger (trigger arm) indicating it is ready for the trigger event to occur. As soon as the trigger condition is satisfied, the logic trigger sends a signal back to the timebase. The timebase then begins counting down the posttrigger delay counter. When the countdown reaches zero, the sample clocks to the memory address counters are stopped and the 68000 is signaled that the acquisition is complete.

**Fine Interpolator.** The fine interpolator is a dual-slope interpolator circuit that acts as a time-interval stretcher to supply the trigger timing information to the timebase. When the logic trigger receives a signal that meets the

programmed triggering requirements, it signals the timebase. The timebase then sends a pulse to the fine interpolator. The pulse is equal in width to the time between the trigger and the next sample clock. The fine interpolator stretches this time out by a factor of 250. Meanwhile, the timebase runs a counter (off the 40 MHz oscillator) until the fine interpolator indicates the stretch is complete. These are the sample points stored by the timebase for the 68000 to use for displaying the acquired data.

**D/A Converter.** The digital-to-analog converter (DAC) has 16 outputs and is programmed to set the levels for channel DC offset, trigger level, trigger hysteresis, and levels going to the A/D converter. The highest level out of the DAC is 5 V dc, and the lowest is 0 V dc. The voltages between those two levels are pulses from 0 to 5 V, varying in width. The DAC outputs go through op amp filters to convert the pulse streams to dc levels. The dc levels are then applied to the appropriate circuits.

**Acquisition RAM.** The acquisition memory is 2K X 8 bits of RAM.

The sample clock from the timebase is gated with digital circuitry and some of the control lines and applied to memory address counters of the acquisition RAM. The memory address counters step through the address locations of RAM and their rate is the rate data is acquired.

When the 68000 is signalled by the timebase that the data acquisition is complete, the data is then transferred to the system RAM.

The data stored in system RAM is the data from the A/D converters interleaved with the interpolation information stored by the timebase.

The 68000 retrieves the data from memory (system RAM) to display on the CRT monitor. The timing information of the trigger event relative to the sample clock is the data from the timebase. The 68000 uses this data for placing the sample points at the correct locations on the display.

## 6-11. System Control

The system control of the HP 54501A consists of a 68000 microprocessor and the associated circuitry required to control the acquisition section of the System Board Assembly and the display monitor. The interfaces for HP-IB and keyboard assemblies are also included on the system board. Figure 6-3 is the block diagram for system control of the HP 54501A.

### Central Processing Unit (CPU)

The CPU for the HP 54501A is the 68000 P10 microprocessor with addressing capability of 16 Megabytes (23 address lines/16 data lines). The CPU receives its clock from the TCL (Timing Control Logic) at the rate of 9.8304 MHz (10 MHz creating a cycle time of 101.7 nanoseconds (100 nsec). TCL provides all timing for the CPU including timing control of bus arbitration. Therefore, the bus grant output from the CPU is not used. The CPU drives the read/write line and the address and data strobes.

The CPU activates a free-running 1 MHz enable clock for synchronization with the CRT Controller (CRTC). The TCL generates the Valid Peripheral address signal on behalf of the CRTC to complete the peripheral control timing.

**Power.** System control of the HP 54501A requires +5 volts dc (relative to digital ground) and +12 volts dc (relative to display ground) for operation. System control supplies the display board with +5 volts, +12 volts, display ground and digital ground. The beeper/clicker circuit is operated off the +12 display voltage, the remaining system control circuitry is operated from the +5 digital voltage.

**Clock.** The fundamental clock period for system control is derived from a 19.668 MHz (20 MHz) crystal oscillator. The fundamental system control clock is multiplexed and distributed to provide synchronization for the timing control logic (TCL), the dot rate for the display circuitry, and a high-frequency signal to data acquisition for the AC Calibrator Output signal on the rear panel.

### Timing Control Logic (TCL).

Timing Control Logic (TCL) is responsible for providing timing and control for System Control of the HP 54501A.

The TCL circuitry consists of PALs (programmable array logic), various logic gates, LRC delay circuit, and miscellaneous circuitry for arbitrating between display and refresh requests for display and system RAMs. The PALs and arbitrator circuitry are synchronized with the 20 MHz clock, while the LCR delay circuit and miscellaneous gates are asynchronous.

The signals generated by TCL include a hardware select line to the decoders, write-enable to protected non-volatile Static RAM, and all timing and control signals for the interface circuits.

**Beeper/Clicker.** The beeper/clicker is the sound effect for the HP 54501A. The beeper is not utilized by the HP 54501A. The clicker sounds when warning or error messages are displayed, when a key on the keypad is pressed and when the RPG is rotated.

The 3 kHz square wave required by the clicker for operation is provided by the CRT Controller.

The clicker may be deactivated via the UTILITY menu.

**Reset/Preset.** The reset/preset circuitry consists of a voltage divider, reference voltage, and comparator to provide the System Board Assembly with a timeout during power up and power down of the HP 54501A. This timeout signal is applied to critical time and power sensitive ICs on the board. The signal goes to the microprocessor, the TCL, decoders, and HP-IB and data acquisition interfaces.

When power is applied, as the +5 V supply crosses the upper threshold of the comparator, the timeout signal of approximately 200 milliseconds is generated and applied to the system control circuitry assuring the board powers up in a known state.

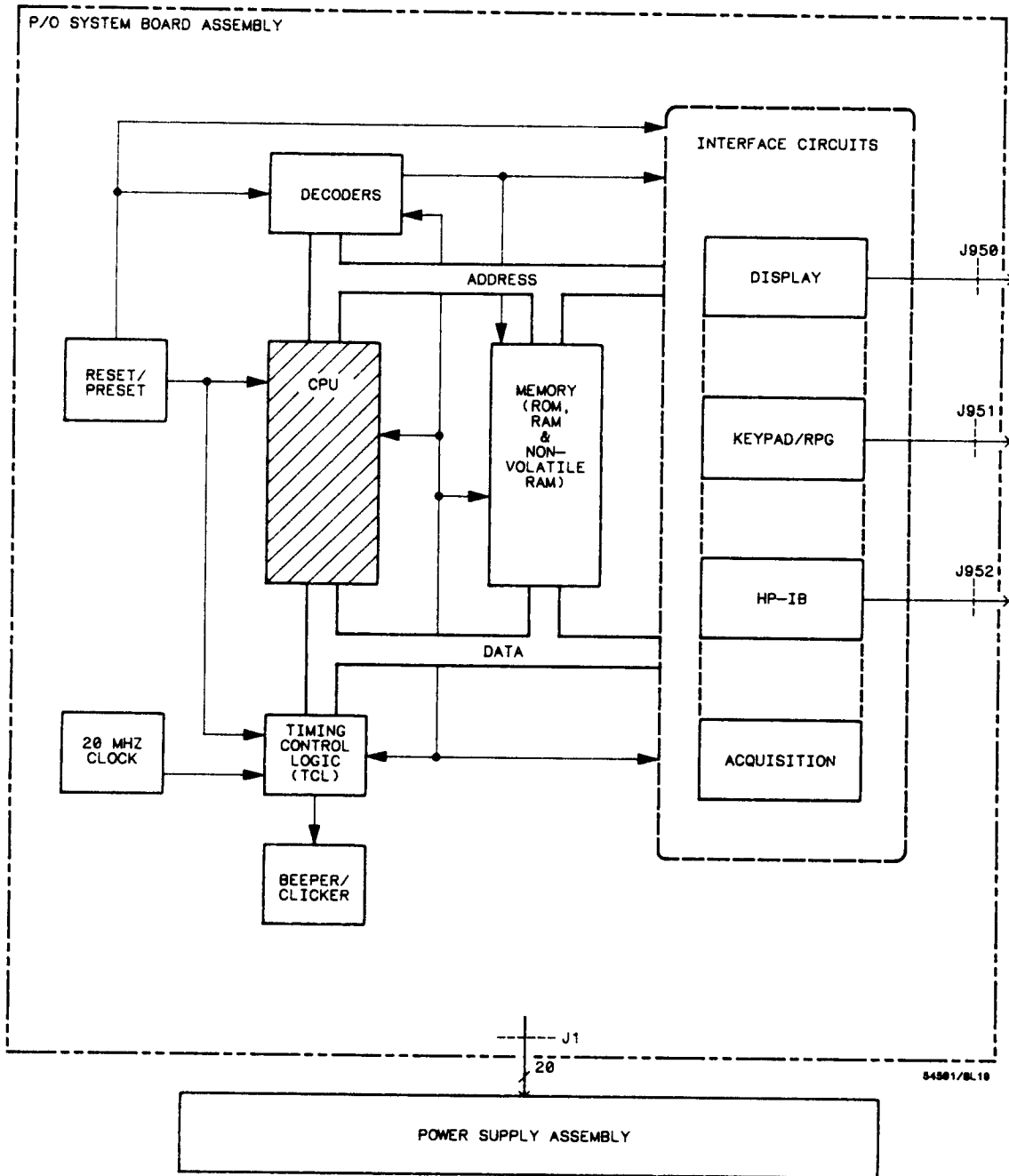

Figure 6-3. HP 54501A System Control Block Diagram

Similarly, when power is removed, as the +5 V supply crosses the lower threshold of the comparator, the timeout halts the microprocessor and resets all critical timing before the +5 V supply falls below the valid operating region for TTL.

**Decoders.** The four upper address lines (A23, A22, A21, and A20) are decoded into functional operations for system ROM, non-volatile static RAM, system RAM, display RAM, keyboard, HP-IB, CRTIC, and an operation called DEVICES.

The DEVICES operation is further decoded to clear the RPG and interrupts on the microprocessor, address the RPG and clicker/beeper, and provide a latch to the data acquisition.

The address strobe from the microprocessor and a hardware chip select line from the TCL provide the functional timing for the address decoders.

**Memory.** Memory for the system control of the HP 54501A is composed of System ROM, System RAM, and static RAM.

There are 3 Megabits of System ROM configured as two 128K X 8 and one 64K X 16 (256K + 128K) for 384K bytes of CMOS EPROM with 200 nanoseconds access time. System ROM is used to store system operating code, look-up tables, constants, default calibration factors, etc.

The 4 Megabits of System RAM are configured as four 256K X 4 for 512K bytes of CMOS dynamic RAM with a 220 nanosecond cycle time. The address inputs to each of the four RAMs are multiplexed to create an internal array of 512 X 512 X 4. Nine address lines are used for row decoding and nine are used for column decoding. The System RAM uses the conventional RAS/CAS timing scheme for read/write and refresh. System RAM stores variables, acquisition data for displaying, and provides scratch-pad memory for the microprocessor.

The CMOS static RAM is configured as 32K X 8 with a 120 nanosecond access time. The static RAM is combined with a smart socket

that has a built-in controller circuit and an imbedded lithium energy source. The smart socket monitors the supply voltage (Vcc). When Vcc falls below an acceptable voltage level, such as during power-down of the HP 54501A, the internal lithium source is automatically switched on and write protection is unconditionally enabled to prevent garbled data. The non-volatile static RAM stores menu configurations, calibration factors, and up to four waveforms. Normal power-up of the HP 54501A restores the calibration factors as stored in non-volatile memory and menu configurations from the last power-down state. A key-down power-up, in which any key is held down during power-up, does not affect calibration factors previously stored in non-volatile memory but resets the HP 54501A menu configurations to known settings.

**Interface Circuits.** System Control of the HP 54501A interfaces with four major communication circuits. These four circuits are the display monitor, front-panel keypad and RPG, HP-IB and acquisition.

The **display interface** consists of a CRT controller IC (CRTIC), display RAM, shift registers, and buffers for address and data lines.

The CRTIC provides the horizontal and vertical sync signals for the CRT and a disable/enable signal for TCL that is used for generating the necessary timing for addressing the CRT screen.

The display RAM is configured in a row/column matrix. Counters track the memory location in display RAM versus positioning the data on the CRT as data is shifted from display RAM to two shift registers. The output of the shift registers is two data streams. One stream is displayed as full-bright pixel information on the CRT and the other as half-bright. A character ROM is not utilized in the display interface because all character matrices are stored in System ROM.

The **HP-IB interface** circuitry supports communication with other instruments (printer, controller, automated test equipment, etc.) The circuit consists of three main components. The TMS 9914 GPIB controller provides an interface between the microprocessor system

and the HP-IB in accordance with IEEE 488 standards. The 75160 is an 8-bit data buffer and the 75162 is an 8-bit control line buffer.

The HP-IB is a 24-pin shielded cable carrying 8 data lines, 8 control lines, 7 system grounds, and 1 chassis ground.

The **keypad/RPG interface** is interpreted as an 8 X 8 matrix with 8 row lines connected through an open-collector buffer to the 8 lower address lines and the 8 column lines connected through a tri-state buffer to the 8 lower data lines.

The **acquisition interface** consists of 16 functional lines: 3 data latch controls, 4 logic trigger functions, 2 DAC functions, 3 timebase functions, and four unused selects. Other interface circuitry is made up of buffers for address and data lines and five latched data lines for control signals to the Timebase and Logic Trigger and the calibration outputs to the HP 54501A rear panel. The CPU provides 3 clocks to acquisition via the interface: 1.5 kHz to rear panel DC Calibrator Output, 2.5 MHz for dither, and 20 MHz to D/A Converter and Probe Compensation AC Calibrator Output.



6-12. TROUBLESHOOTING

6-13. Troubleshooting Flowcharts

This section consists of troubleshooting flowcharts, module signal level tables, module signal level tables. The flowcharts refer to the tests and tables to help isolate trouble. Disassembly procedures are included at the end of this section to direct in replacing faulty modules. The circled numbers on the first chart indicate the entry point of the next flowchart for isolating a problem.

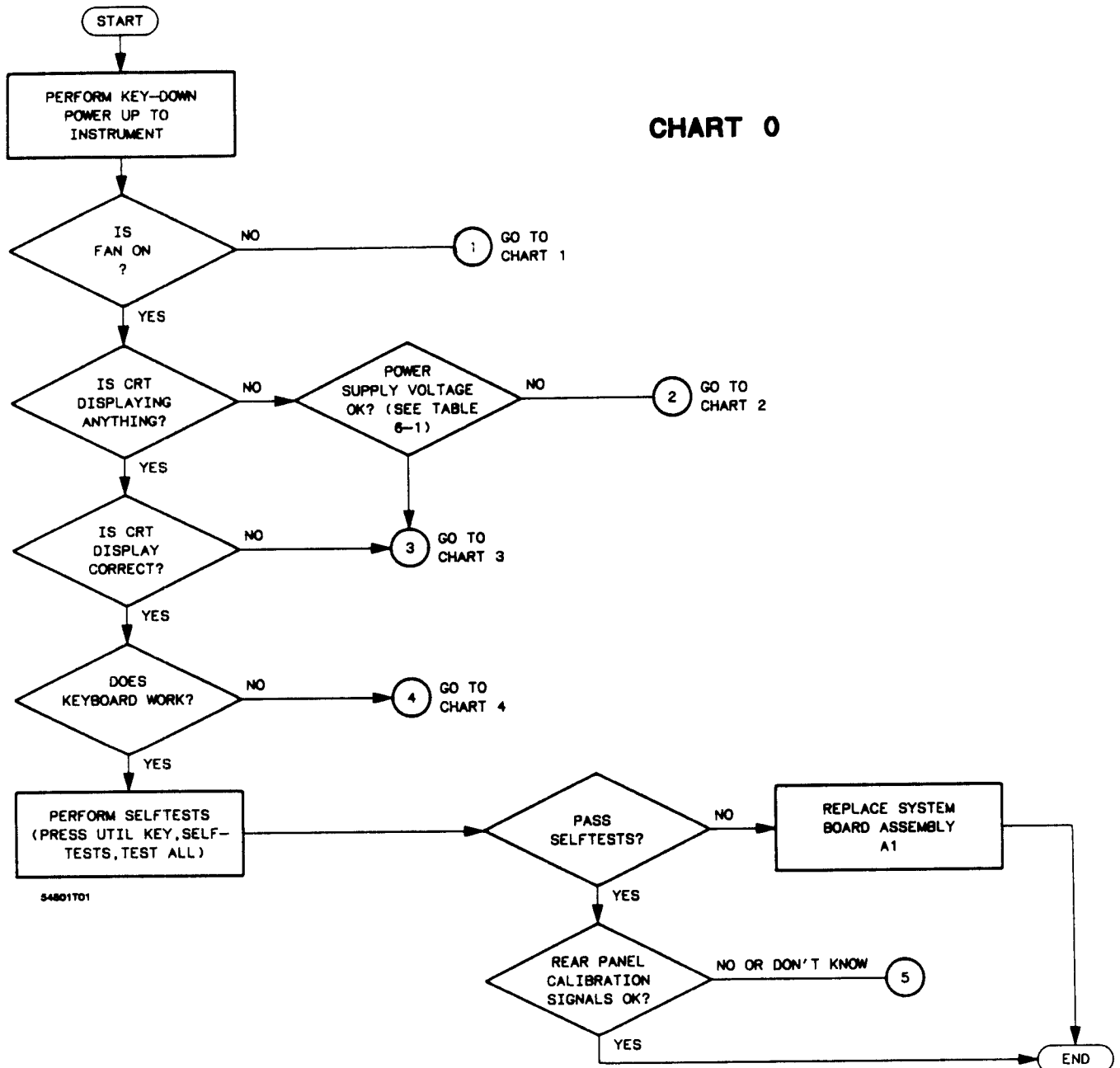
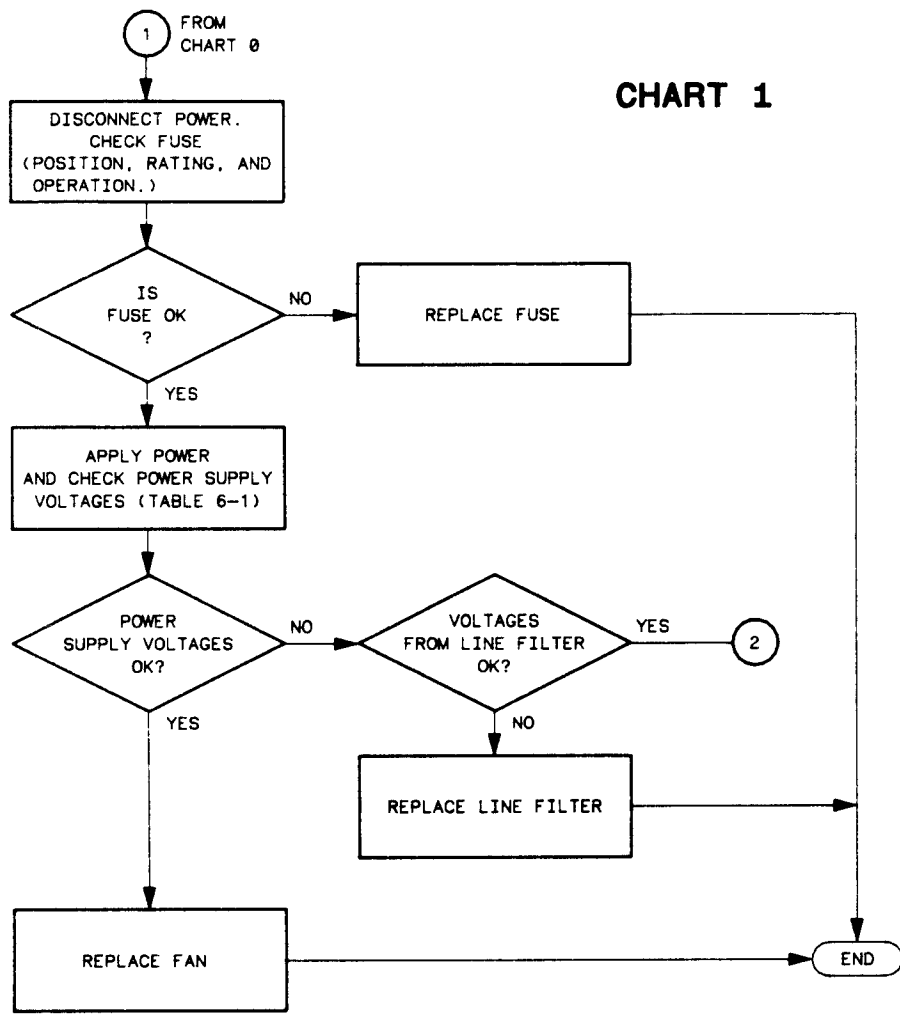

Figure 6-4. General Trouble Isolation Flowchart for HP 54501A



54501/1802

Figure 6-5. Trouble Isolation Chart for HP 54501A Fan/Fuse

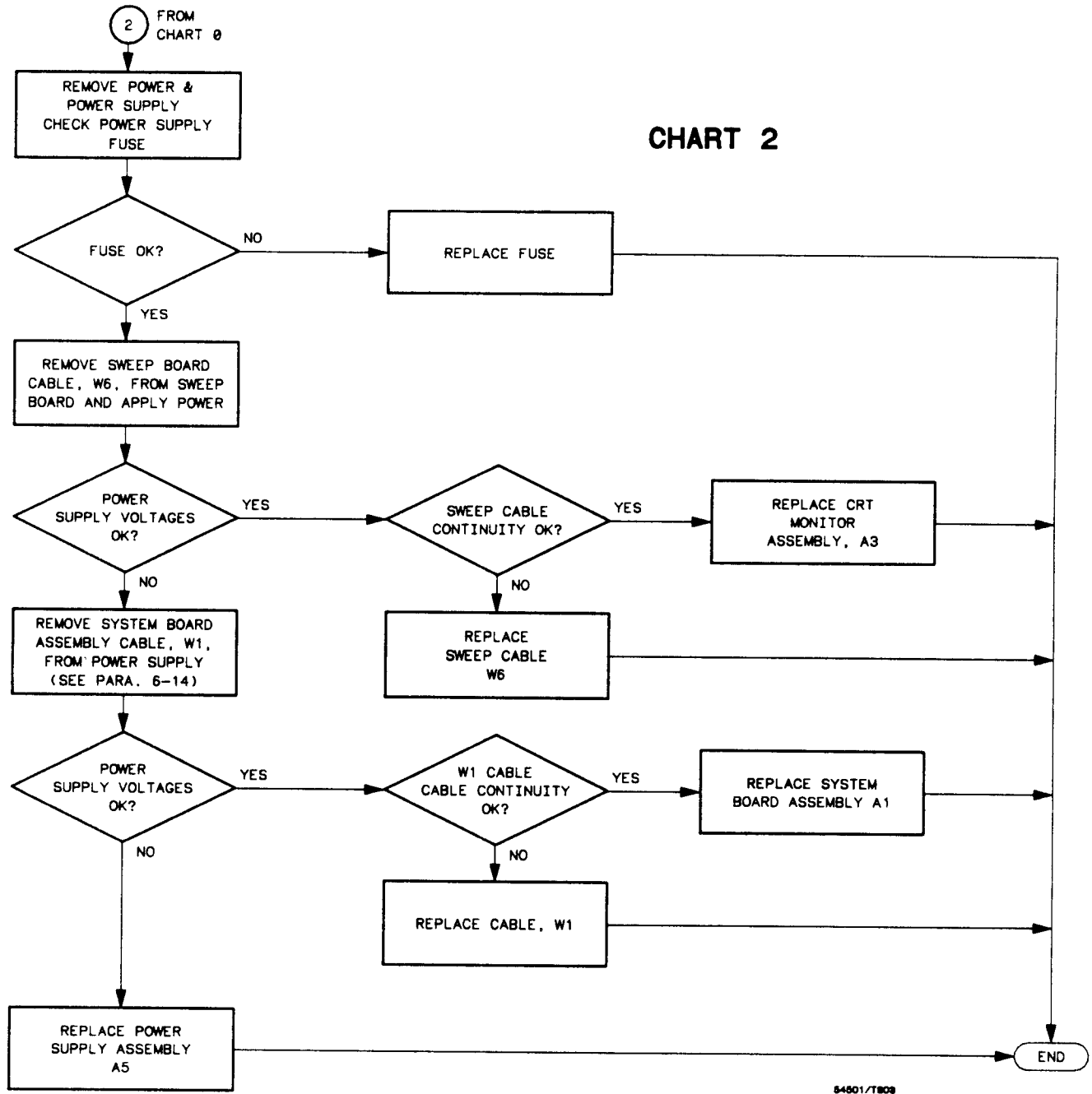

Figure 6-6. Trouble Isolation Flowchart for HP 54501A Power Supply

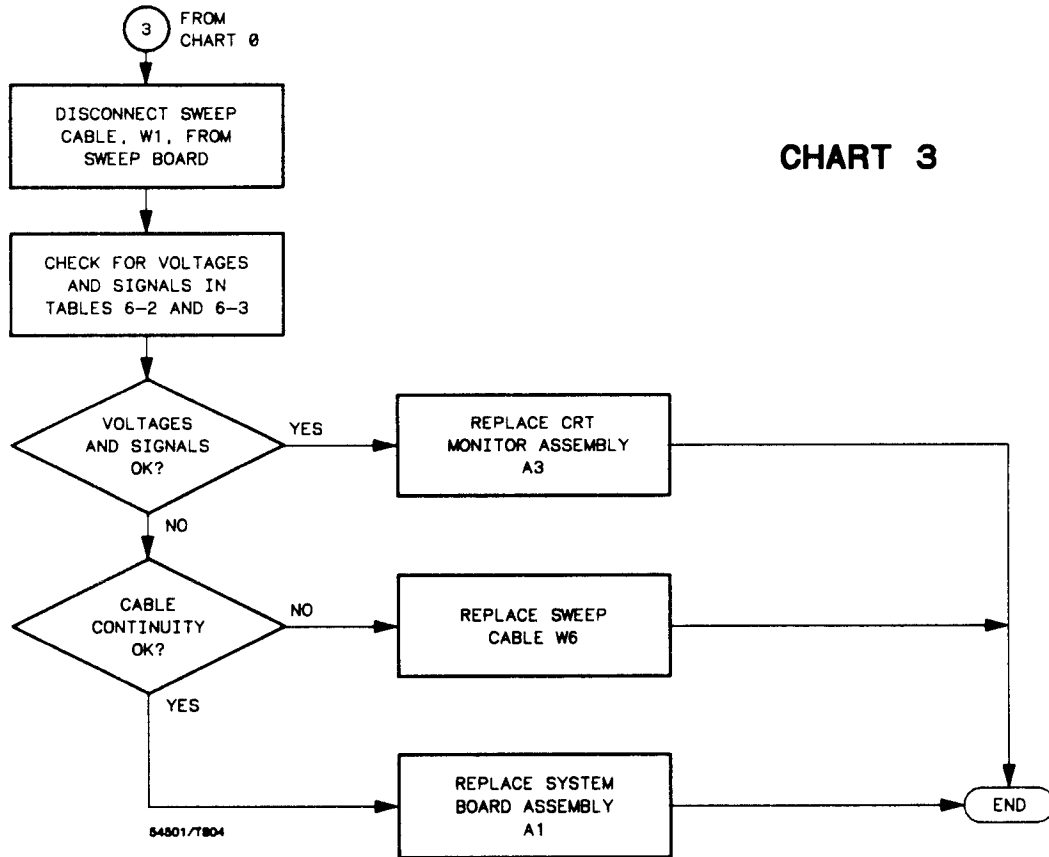

Figure 6-7. Trouble Isolation Flowchart for HP 54501A CRT Monitor

**CHART 4**

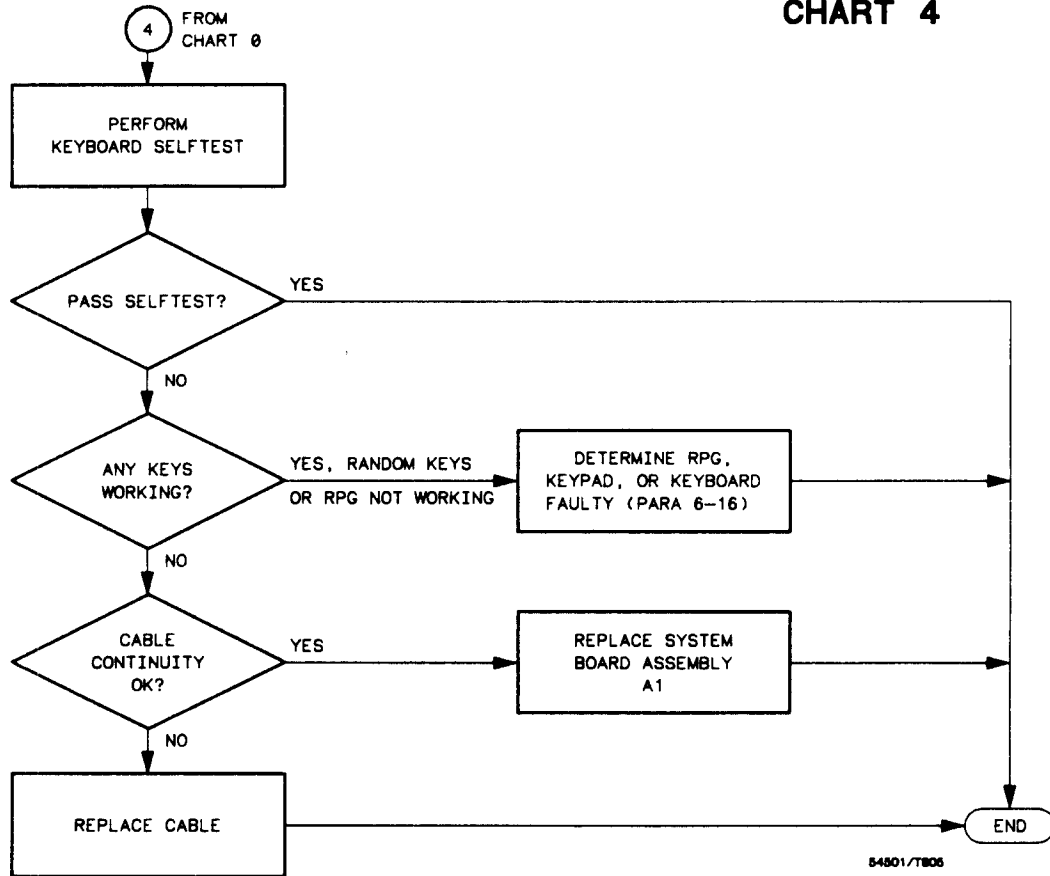

Figure 6-8. Trouble Isolation Flowchart for HP 54501A Keyboard

**NOTE**

*Keydown power-up must be performed on HP 54501A before selftests are invoked. This ensures critical parameters to the selftests are set and erroneous conditions will not result.*

CHART 5

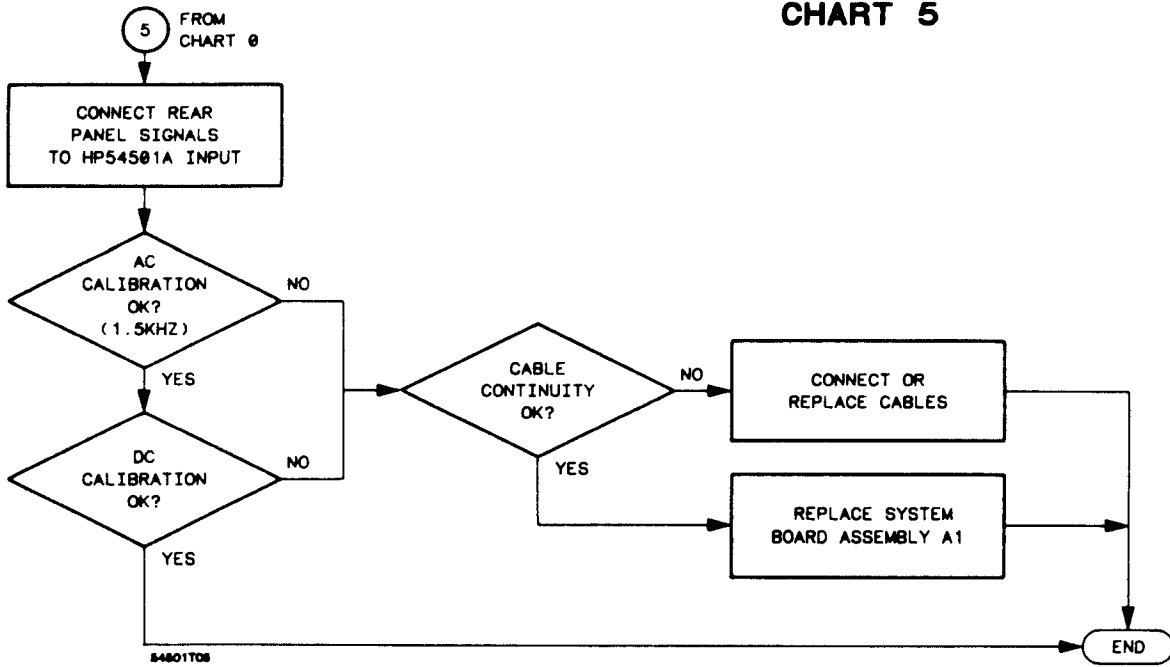

Figure 6-9. Trouble Isolation Flowchart for HP 54501A Calibration Signals

## 6-14. Power Supply Voltages Check

**WARNING**

*This procedure is to be performed only by service-trained personnel aware of the hazards involved (such as fire and electrical shock).*

1. Remove top cover from instrument.
2. Refer to figure 6-10 for locations of power supply test points.
3. Check voltages on power supply test points for voltages in figure 6-10.
4. The power supply can be isolated to check output voltages with the following steps.
  - a. Remove power cable from instrument.
  - b. Disconnect cable W1 from power supply as in figure 6-10.
  - c. Load +5.15 V supply with resistor (see Recommended Test Equipment in section 1). Use alligator clips to connect one end of the resistor to any pin 1-4, and the other end to any pin 5-8.
  - d. Connect power cable and check for voltages in table 6-1.

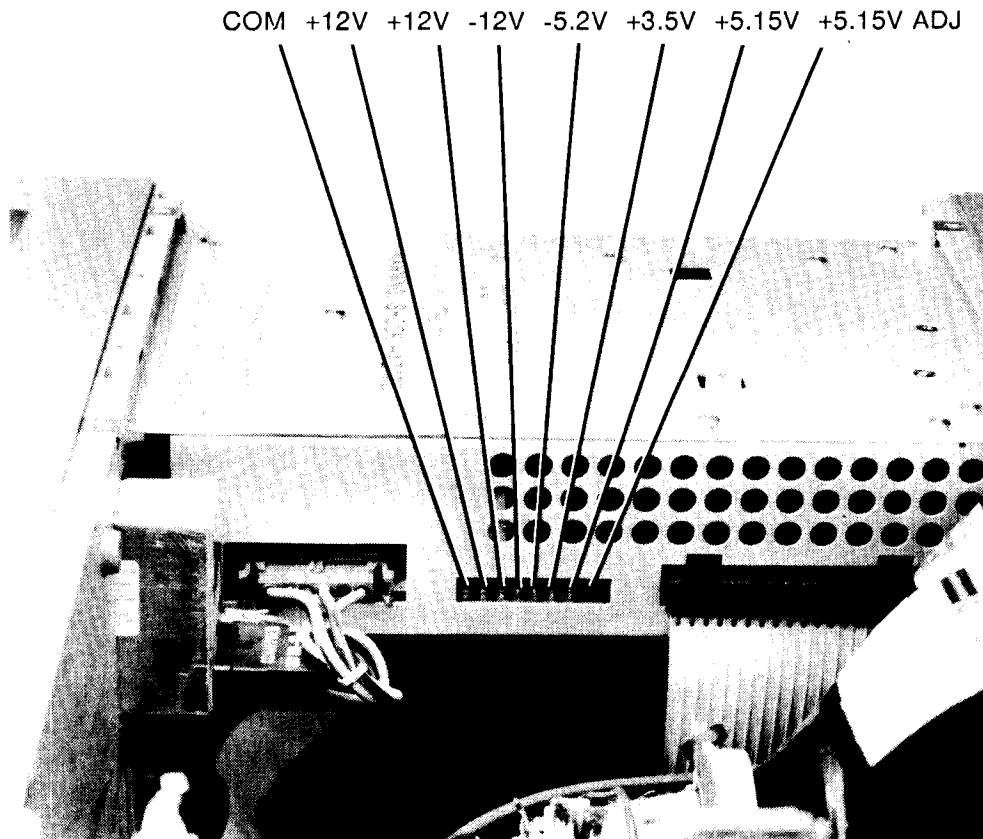

Figure 6-10. HP 54501A Power Supply Test Points

Table 6-1. Power Supply Assembly/System Board Assembly Voltages

PIN	SIGNAL	PIN	SIGNAL
1	+5.15 V (ANALOG)	11	-5.2 V (ANALOG)
2	+5.15 V (ANALOG)	12	GROUND (ANALOG)
3	+5.15 V (DIGITAL)	13	+12 V (ANALOG)
4	+5.15 V (DIGITAL)	14	GROUND (ANALOG)
5	GROUND (DISPLAY)	15	-12 V (ANALOG)
6	GROUND (DIGITAL)	16	GROUND (ANALOG)
7	GROUND (DIGITAL)	17	+12 V (DISPLAY)
8	GROUND (ANALOG)	18	-5.2 V (ANALOG)
9	+3.5 V (ANALOG)	19	+15.5 V (FAN)
10	GROUND (ANALOG)	20	GROUND (FAN)

**NOTE**

*The ground planes (digital, analog, and display) are at the same potential on the power supply, but at board level the supplies must be measured to the respective ground.*



## 6-15. CRT Monitor Signals Check

1. Remove top cover from instrument.
2. Check W6 for signals listed in table 6-2. Refer to figure 6-13 for cable location. The dynamic video signals FB (FULL BRIGHT) and HB (HALF BRIGHT) are single-ended TTL inputs. Check for activity on these pins. Table 6-3 is the truth table for these signals.

Table 6-2. CRT Monitor Assembly Cable Pin Assignments

PIN	SIGNAL DESCRIPTION	PIN	SIGNAL DESCRIPTION
1	+5 V (DIGITAL)	2	+12 V (DISPLAY)
3	GROUND (DISPLAY)	4	GROUND (DISPLAY)
5	+12 V (DISPLAY)	6	GROUND (DISPLAY)
7	+12 V (DISPLAY)	8	GROUND (DISPLAY)
9	+12 V (DISPLAY)	10	HSYNC
11	VSYNC	12	+12 V (DISPLAY)
13	GROUND (DIGITAL)	14	GROUND (DIGITAL)
15	GROUND (DISPLAY)	16	FB
17	GROUND (DISPLAY)	18	HB
19	GROUND (DISPLAY)	20	+5 V (DIGITAL)

Table 6-3. FB and HB Truth Table

FB	HB	Video Output
0	0	Off
0	1	Half-bright
1	0	Full-bright
1	1	Full-bright

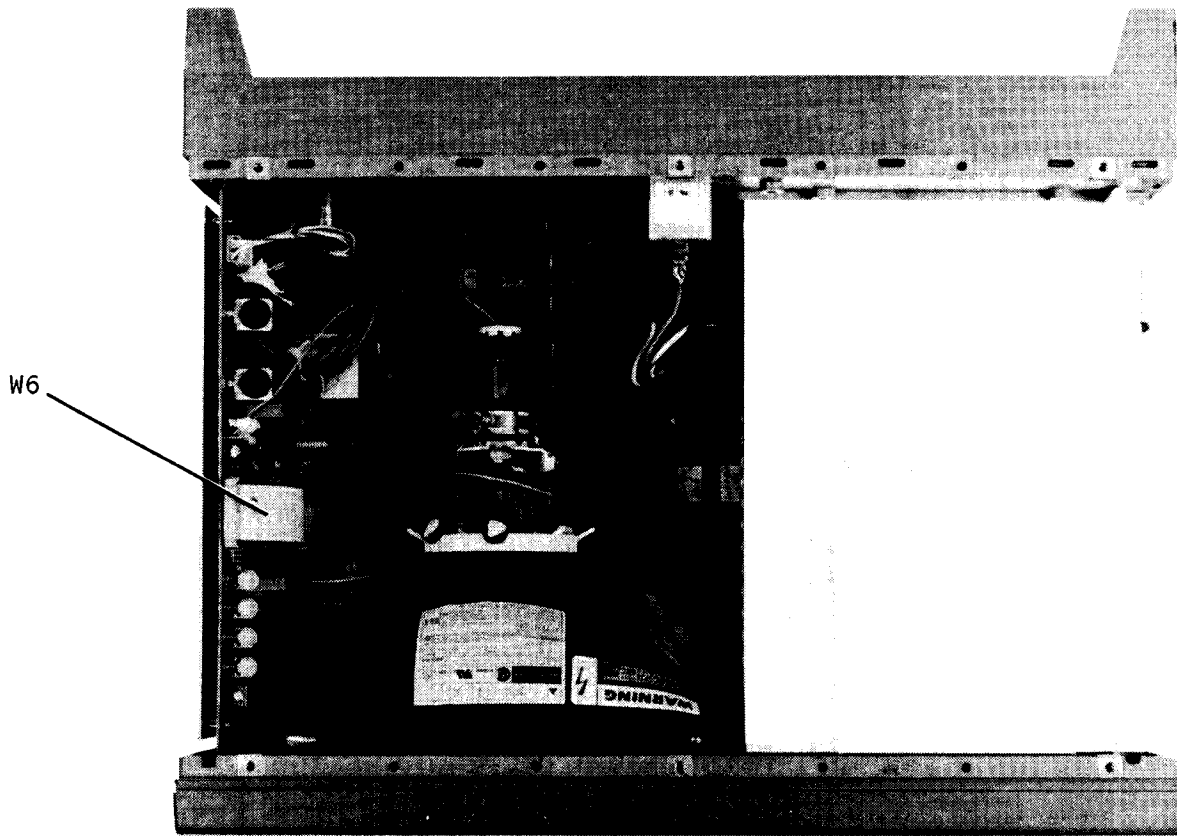

Figure 6-13. HP 54501A CRT Monitor Assembly Cable, W6, Location

## 6-16. HP 54501A Keyboard Signals Check

1. To isolate faulty elastomeric keypad or keyboard when random key(s) not operating, perform the following steps:
  - a. Remove top cover and power supply. (Refer to **Removal and Replacement of Power Supply Assembly**, if necessary.)
  - b. Remove the four screws securing the keyboard assembly to the front panel.
  - c. Replace power supply and apply power to the instrument.
  - d. Run Keyboard Self Test. If keydown power-up was not performed when power was applied, do so before invoking the self test.
  - e. Allow keyboard assembly to fall forward from front panel and separate the elastomeric keypad from the printed circuit keyboard.
  - f. Short keyboard trace (with a paper clip or screwdriver) of non-operating key and look for appropriate response on display.
  - g. If display responds as if key were pressed, replace elastomeric keypad.
  - h. If display does not respond to short as if key were pressed, replace keyboard.
  
2. The row scan signal of 60 Hz is present at all times. This signal is found on pins 14 through 20 of keyboard cable connector. The same signal is on pins 3 and 9 through 13 only when a key is being pressed. Refer to table 6-4 for all signals going to and from the keyboard.

Table 6-4. Keyboard Connector Voltages and Signals

PIN	SIGNAL	PIN	SIGNAL
1	RPG A	2	RPG B
3	COLUMN DATA*	4	COLUMN DATA*
5	COLUMN DATA*	6	COLUMN DATA*
7	COLUMN DATA*	8	COLUMN DATA*
9	COLUMN DATA*	10	COLUMN DATA*
11	60 HZ SCAN	12	COLUMN DATA*
13	60 HZ SCAN	14	60 HZ SCAN
15	60 HZ SCAN	16	60 HZ SCAN
17	60 HZ SCAN	18	60 HZ SCAN
19	+5 (DIGITAL)	20	60 HZ SCAN

\* Row scan signal of 60 Hz is on these pins only when a key in the corresponding column is pressed.

## 6-17. ASSEMBLY REMOVAL AND INSTALLATION

This section contains the procedures for removal and installation of the oscilloscope system board, CRT monitor, power supply, fan and keyboard assemblies. Read the Safety Summary at the front of this manual before servicing the instrument.

### WARNING

*Hazardous voltages exist on the power supply, the CRT assembly, and the display sweep board. To avoid electrical shock, the following procedures should be closely adhered to. Wait at least three minutes for the capacitors on the power supply and sweep boards to discharge before servicing this instrument.*

### CAUTION

*Never remove or install any circuit board with the instrument power ON. Component damage may occur.*

## 6-18. Removal and Replacement of Rear Panel Assembly

1. Disconnect power cable.
2. Remove the six screws from top and the two screws from each side of the instrument with TORX® 10 screwdriver.
3. Lift top cover off.
4. Detach line filter cable, W7, from power supply.
5. Remove the eight screws from the rear panel with TORX® 15 screwdriver.
6. Remove rear panel from instrument cabinet.
7. Replace rear panel by reversing this procedure.

## 6-19. Removal and Replacement of Power Supply Assembly

1. Disconnect power cable.
2. Remove the six screws from top and the two screws from each side of instrument cabinet with TORX® 10 screwdriver.
3. Lift top cover off.
4. Remove cable W1 attaching power supply to System Board Assembly.
5. Detach line filter cable, W7, from Power Supply Assembly.

6. Remove the two PCB (printed circuit board) retainers securing Power Supply Assembly from right front and rear corners of the instrument cabinet by pulling retainers up and out.
7. Slide Power Supply Assembly out through side of instrument cabinet.
8. To replace Power Supply Assembly, reverse this procedure.

### NOTE

*When installing the Power Supply Assembly, make certain power supply connectors are directed to inside of instrument.*

## 6-20. Removal and Replacement of Keyboard Assembly

1. Disconnect power cable.
2. Remove power supply by following the steps previously detailed in **Removal and Replacement of Power Supply Assembly**.
3. Detach keyboard cable, W5, from System Board Assembly.
4. Remove the four screws securing Keyboard Assembly to front of instrument cabinet.
5. The Keyboard Assembly (label overlay, housing, keypad, keyboard, RPG and knob) will come off front panel as one unit.
6. To disassemble the Keyboard Assembly, follow these steps:
  - a. Pull RPG knob to remove Keyboard Assembly from front panel.
  - b. Elastomeric keypad is not attached to keyboard and may be lifted from assembly.
  - c. Pull to remove knob from Keyboard assembly.
  - d. Remove 7/16 inch nut and washer holding RPG to Keyboard Assembly.
  - e. Disconnect cable from keyboard printed circuit board.
7. Disconnect RPG cable from keyboard assembly.
8. Replace Keyboard Assembly by reversing this procedure.

## 6-21. Removal and Installation of System Board Assembly

**CAUTION**

*The effects of ELECTROSTATIC DISCHARGE may damage electronic components. Use grounded wriststraps and mats when servicing the System Board Assembly.*

1. Disconnect power cable.
2. Remove the six screws from top and the two screws from each side of instrument.
3. Lift top cover off.
4. Detach line filter cable, W7, from Power Supply Assembly.
5. Remove dc power supply cable, W1.
6. Remove the two PCB (printed circuit board) retainers from right front and rear corner of Power Supply Assembly.
7. Remove Power Supply Assembly by sliding out through side of instrument.
8. Disconnect fan cable B1W1 from System Board Assembly.
9. Disconnect keyboard cable, W5, and HP-IB Cable, W4, from System Board Assembly.
10. Remove rear panel by removing the eight screws securing it to instrument and lifting off. Refer to previous paragraph **Removal and Installation of Rear Panel** , if necessary.
11. Carefully place instrument in front-panel-down position or on its side and remove the EIGHT #10 TORX  screws on the bottom of the instrument that secure System Board Assembly to cabinet.
12. Remove the four 5/8 inch nuts holding System Board Assembly BNCs to front panel.
13. Slide System Board Assembly out of cabinet through rear of instrument.
14. Replace System Board Assembly by reversing this procedure.

## 6-22. Removal and Replacement of CRT Monitor Assembly

1. It is necessary to remove System Board Assembly from instrument in order to remove hardware securing CRT to instrument cabinet. Refer to **Removal and Replacement of System Board Assembly**, if necessary.
2. Connect a jumper lead between ground lug of CRT and shaft of a screwdriver. To discharge CRT, place screwdriver under protective rubber cap of post accelerator lead and momentarily touch screwdriver to metal clip of post accelerator lead.

**CAUTION**

*Discharge the post accelerator lead to a grounding lug only. Components will be damaged if the post accelerator is discharged to other areas.*

**NOTE**

*The CRT may charge up by itself even while disconnected. Discharge the CRT before handling by shorting the post accelerator terminal of the CRT to the ground lug with a jumper lead.*

3. Disconnect post accelerator lead from CRT by firmly squeezing rubber cap until metal clip disengages from CRT.
4. Detach intensity cable, W7, from sweep board.
5. Detach sweep cable, W6, from sweep board and CRT Monitor Assembly cables from CRT and sweep board.
6. Slide sweep board up and out of cabinet slot.

**NOTE**

*When installing sweep board, it may be necessary to press on center of the outer shield of sweep board to allow the board to clear cabinet support rib.*

7. Carefully place instrument in front-panel-down position.
8. Remove the three 7mm nuts securing CRT to front panel..
9. Remove the #15 TORX® screw securing CRT to front panel.
10. Remove CRT and ground bracket from front panel of instrument.

### NOTE

*When installing CRT, make certain that CRT yoke is properly aligned. THE GROUND BRACKET MUST BE INSTALLED BEFORE THE CRT.*

11. To install CRT Monitor Assembly, reverse this procedure.

### NOTE

*After replacement of CRT Monitor Assembly, **only if necessary**, perform the CRT adjustment procedures detailed in section 4 of this manual.*

## 6-23. Removal and Replacement of Fan

1. Disconnect power cable.
2. Remove the six screws from top and the two screws from each side of instrument.
3. Lift off top cover.
4. Remove rear panel from instrument cabinet. Refer to **Removal and Installation of Rear Panel Assembly**, if necessary.
5. Detach line filter cable, W8, from power supply.
6. Detach fan cable, B1W1, from System Board Assembly.
7. Remove fan by removing the four screws securing it to cabinet.
8. To install fan, reverse this procedure.

### NOTE

*When replacing fan, be sure fan label is to outside of instrument to assure fan cable is directed toward center of rear panel for connection to System Assembly Board.*

## 6-24. Removal and Replacement of Feet/Tilt Stand

1. Remove System Board Assembly. Refer to **Removal and Installation of System Board Assembly**, if necessary.
2. Remove the three #10 TORX® screws securing each foot/tilt stand to the bottom of the cabinet.
3. To install feet/tilt stand, reverse this procedure.



## 6-17. SELFTESTS

The selftests are used for isolating problems in the HP 54501A. A keydown power-up must be performed before invoking the HP 54501A selftests. This ensures critical parameters to the selftests are set to known values to avoid any erroneous results.

The selftests may be invoked from any menu by pressing the front-panel UTIL key and then selecting **selftest menu** softkey. Figure 6-12 is the available choices in the HP 54501A Selftest Menu.

The tests may be run individually or, by selecting **test all** softkey, consecutively. After each selftest has been completed, a message of pass or fail for that selftest will be displayed. If failed messages are displayed for components or circuitry on the System Board Assembly, it may help to perform the adjustment procedures in section 4 of this manual. If the selftests continue to fail, the System Board Assembly must be returned to the factory for service. Component level troubleshooting is not supported in this manual.

The **loop** test in the SELF TEST MENU is used for factory service only.

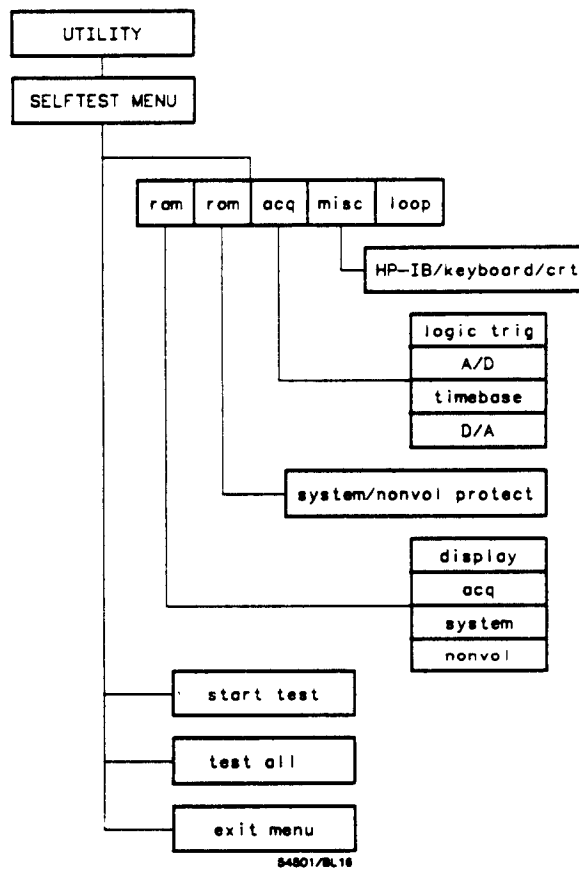

Figure 6-12. HP 54501A Selftest Menu Selections

