

**ZYCOMM 25 Watt 13v
VHF FM Crystal TX RX**

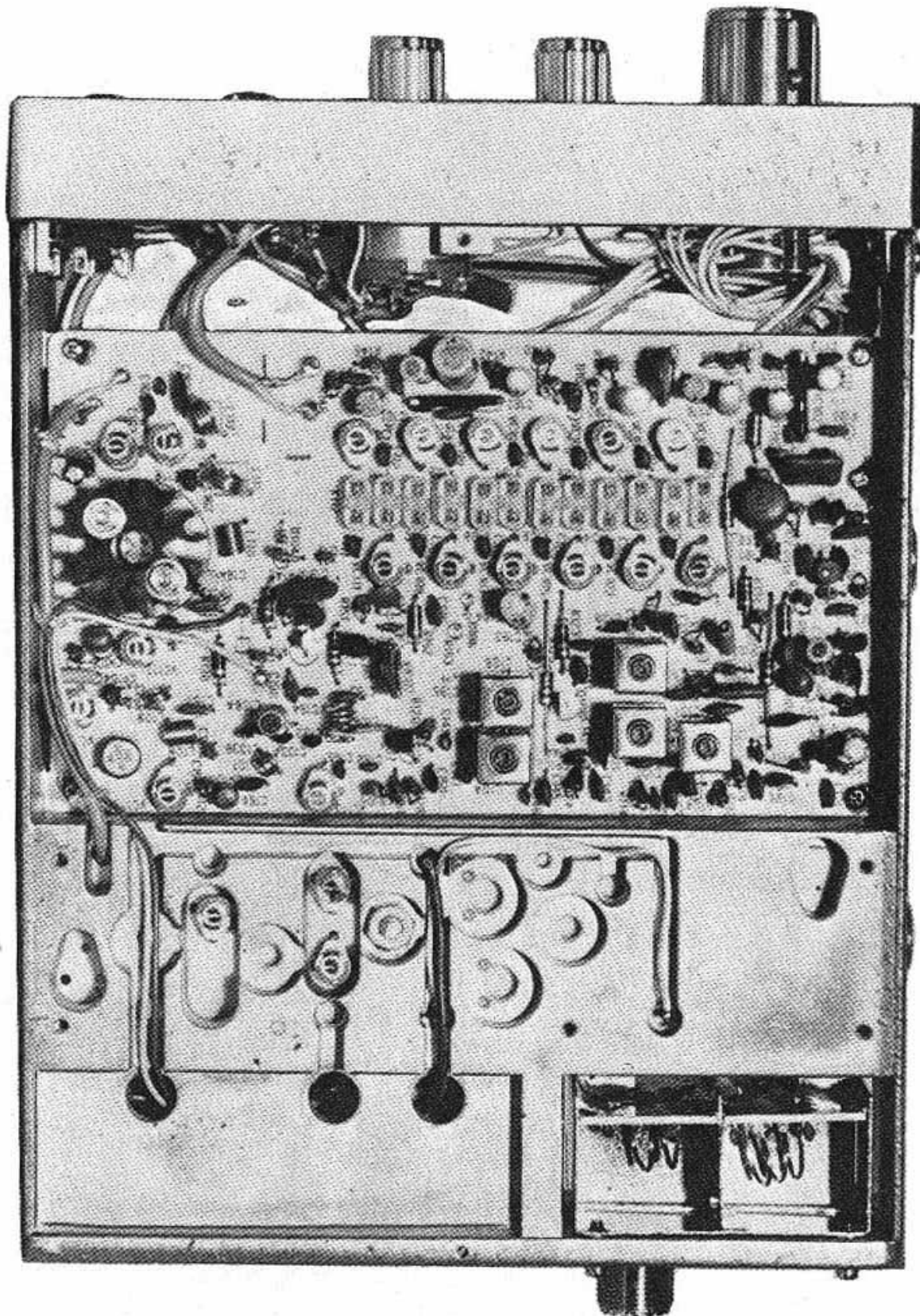

TRANSMITTER EXCITER SIDE

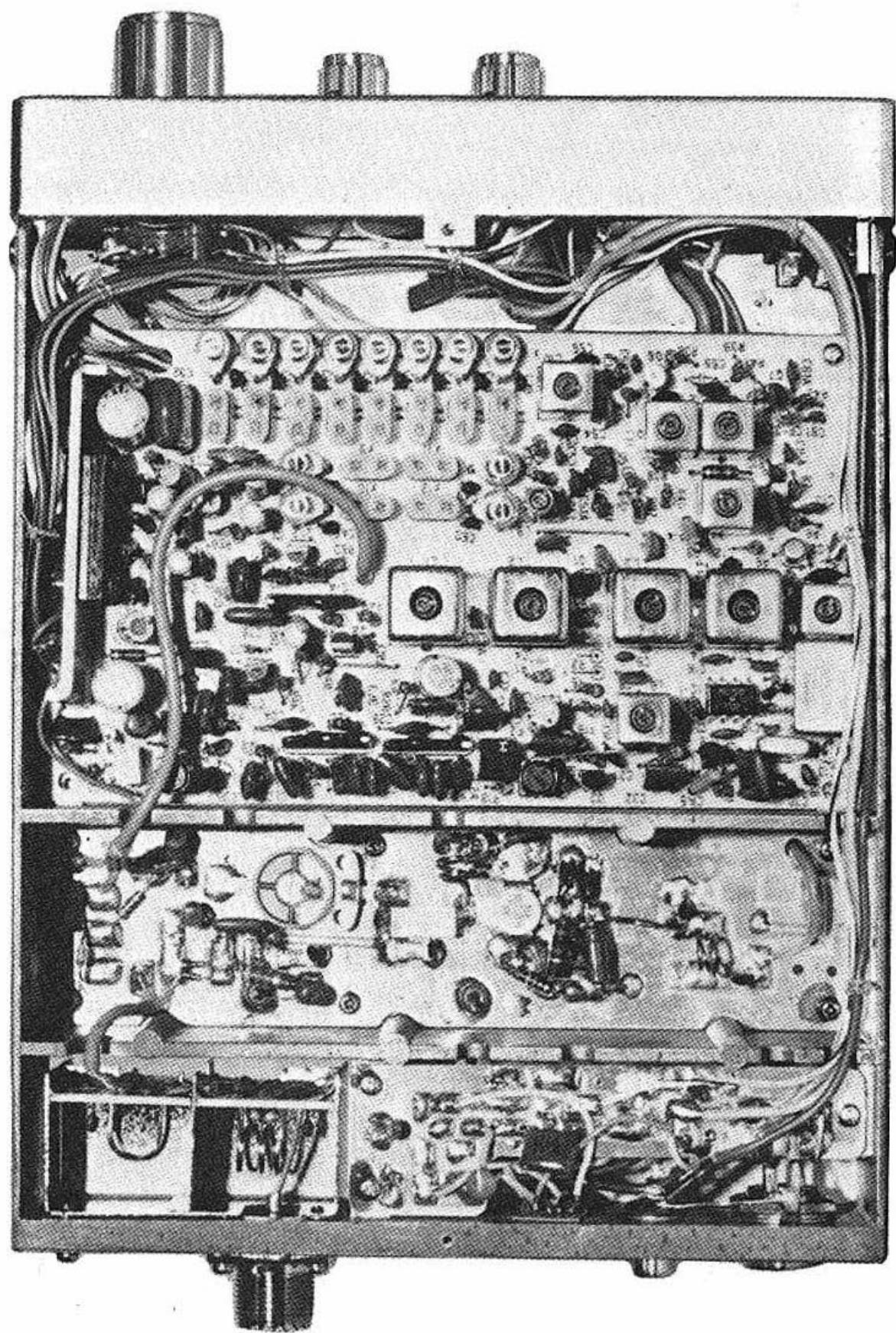

RECEIVER SIDE

ELECTRICAL PERFORMANCE

ZYCOMM
FM 25-12
VHF

GENERAL

Frequency..... 12 assigned spot frequencies
between 134–174 MHz
(space between F1 and F12
should be 500 KHz or less)

Communications System..... Press to talk

Type of Emission..... F3 (phase modulation) ± 2.5 KHz

Microphone..... Dynamic, 600 ohms

Output Impedance..... 50 ohms

Power Source..... DC 13.8 V (directly)
AC 240 V (with recti-
fied power supply)

Power Consumption (13.6 V DC Input).....
25 watt RF output; 4.5 A

Operating Conditions:

Ambient Temperature..... -10°C to $+55^{\circ}\text{C}$
Relative Humidity..... $+40^{\circ}\text{C}$, 95% or less
Power Source Variation... $13.8\text{V} \pm 10\%$ or less

Dimensions and Weight:

Dimensions..... 174m/m (6.85 in.) Wide*
54m/m (2.13 in.) High*
225m/m (8.86 in.) Deep

Weight..... 2.5kgs. (5.51 lbs.)

Approval..... To Home Office, M.P.T. 1301

TRANSMITTER

Frequency Stability..... $\pm 0.0005\%$
(-10°C to $+55^{\circ}\text{C}$)

Frequency Multiplication..... 18 times (3x3x2)

Rated RF Output..... 25 watts

Harmonics and Spurious Emission
..... At 25 watts RF output; 70 dB
or more below carrier level

RECEIVER

Frequency Stability..... $\pm 0.0005\%$ or better
(10°C to $+55^{\circ}\text{C}$) –

Receiver Type..... Double Superheterodyne

Local Oscillator Frequency... (RX Freq. – 16.9)/3

Intermediate Frequencies..... 16.9 MHz. 1st IF
455 KHz. 2nd

Sensitivity..... 0.5 μV or better for 20 dB
quieting

Selectivity..... 85 dB or more down at adja-
cent channel

Spurious Sensitivity..... -80 dB or better

Squelch Sensitivity..... 0.3 μV or better

A. F. Output..... 2.0 watts or more
(10% distortion)

TRANSMITTER CIRCUIT DESCRIPTION

The transmitter circuit consists of a modified Sabaroff type crystal controlled oscillator, buffer amplifier, modulator, frequency multiplier (3 x 3 x 2), amplifier, exciter and power amplifier.

1. Oscillator

To minimize the frequency drift against fluctuations of ambient temperature, a modified Sabaroff type crystal controlled oscillator circuit (Q101) is provided. Capacitors C101-C112 (40pF) and C115 (180pF) are utilized to provide thermal compensation. To prevent fluctuation of oscillator frequency due to changes in source voltage, a voltage regulator is used. The crystal used is HC-25/U. Trimmers VC101-VC112 are provided for adjusting the oscillator frequency. The oscillator frequency is 1/18 of the transmitting frequency.

2. Buffer Amplifier

Q102 and associated components form the buffer stage. It is placed between the oscillator and modulator circuits to prevent interaction between the two circuits. Q104 stabilizes the modulator stage.

3. Modulator

Q103 and associated components provide the phase modulation by vector sum.

4. Frequency Multiplier

The modulated and amplified signal frequency is multiplied up to the transmitting frequency through 3 stages.

1st - Q105 - Tripler

2nd - Q106 - Tripler

3rd - Q107 - Doubler

In these stages, high Q double tuned circuits are employ-

ed to prevent excess unwanted spurious emission. The output from these stages is delivered to the next amplified.

5. Pre-Driver

Q108 and Q109 work as the amplifier. The signal delivered from the frequency multiplier is amplified up to a level which is sufficient to drive the power amplifier.

6. Power Amplifier

The signal delivered from the driver stage is amplified by power amplifier Q210. Output (25W) is delivered to the antenna connector through a switching circuit and low pass filter (Q9 and associated circuitry).

7. Modulator Amplifier

The input signal from the microphone is amplified by IC101 and delivered to the IDC (instant deviation control) circuit where the AF signal is clipped. The AF signal is further amplified by IC102 and coupled to the modulator transistor Q103. The modulation level is adjusted by VR101. The audio frequency response is improved by L106, C167-C170.

8. Voltage Regulator (for Transmitter and P.A. stage)

A voltage regulator circuit, consisting of Q110, Q111, Q112, D105 and associated components, is provided to supply a stabilized 8V source voltage to the transmitter stages regardless of input voltage variations.

9. Voltage Regulator (for RF Amplifiers)

This circuit consists of Q301, Q302, Q303, D301 and other components, and provides stabilized 12V to the driver and power amplifier stages.

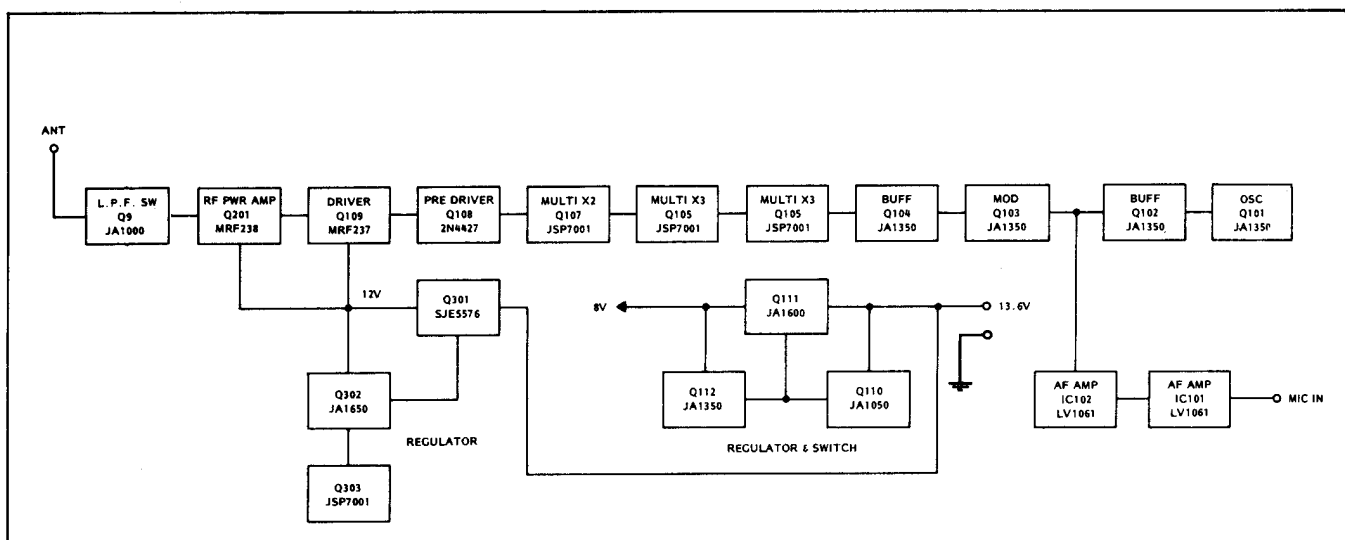

RECEIVER CIRCUIT DESCRIPTION

The receiver is a double superheterodyne circuit consisting of RF amplifier, 1st Mixer, 1st IF Filter, 1st IF Amplifier, 2nd Mixer, 2nd IF Filter, 2nd IF Amplifier, Amplitude clipper, Discriminator and AF Amplifier.

In addition, there are two local oscillator circuits, squelch circuit, and voltage regulator.

1. RF Amplifier

The RF amplifier is made up of Q1 and amplifies the received signal. The spurious radiation from the 1st local oscillator is also sufficiently suppressed in this stage.

2. 1st Mixer

Dual gate field effect transistor Q2 is used in this stage for best intermodulation performance.

The received signal is converted into the 1st intermediate frequency of 16.9 MHz. in this stage.

3. 1st Local Oscillator

The 1st local oscillator circuit is made up of oscillator Q5, buffer amplifier Q6 and frequency tripler Q7. A "Hartley" type oscillator circuit is used for third overtone oscillation.

The receiving frequency of the crystal is (Freq. - 16.9 MHz.) ÷ 3. The supply voltage for the oscillator circuit is regulated through the voltage regulator circuit consisting of Q10 and Q11. Temperature-compensated capacitor, C52 (40pF) provides frequency stability against temperature variations. The signal from the oscillator is amplified by Q6 and frequency multiplied by Q7. The output of the local oscillator is applied to the collector of 1st mixer transistor Q2.

4. 1st IF Amplifier

Represented by IC1. The filtered 16.9 MHz. signal is amplified in this stage.

5. 2nd Local Oscillator

The 2nd local oscillator is Q8. The oscillation frequency is 16.445 MHz.

A pierce type oscillator circuit with temperature compensating capacitor C70 providing good frequency stability against temperature variations.

6. 2nd IF Amplifier

The 2nd IF amplifier consists of amplifier of IC2, IC3 and amplitude clipper Q4. The 455 KHz. IF signal from the 2nd mixer is further amplified in this stage and the amplitude modulation factor is eliminated by the clipper circuit.

7. Discriminator

L8, DIS, D3, D4 and associated components form the discriminator circuit. The frequency modulated information in the received signal is detected and converted into the audio signal in this stage.

8. AF Amplifier

The detected signal is amplified to drive the speaker. The AF amplifier provides maximum output of approximately 2 watts into 8Ω.

9. Squelch Circuit

To ensure reliable operation of the squelch control, the signal which initiates operation of the squelch circuit, is picked up at two points. One is derived from the 2nd IF amplifier through rectifiers D1 and D2 and applied to DC amplifier Q13. The other is picked up at the discriminator output. The noise components from the discriminator are amplified through IC4 and then applied to rectifier/amplifier Q12. The signals from Q12 and Q13 are mixed in Q14 for switching AF amplifier IC5. The squelch level is controlled by VR2. Maximum squelch level (Fully clock-wised position) is adjusted by VR3, the factory adjustment has been done at the antenna input of 3-4 micro volt.

10. Voltage Regulator (including Push-to-Talk circuit)

The voltage regulator circuit consisting of Q10, Q11, D5 and associated components, is arranged to supply stabilized 8V source to the +B line. This eliminates unwanted variations caused by voltage changes.

11. Antenna Switching

Q9 (JA1000) activates the antenna switching diodes D203 and D204 (IS954 for transmitting or receiving mode).

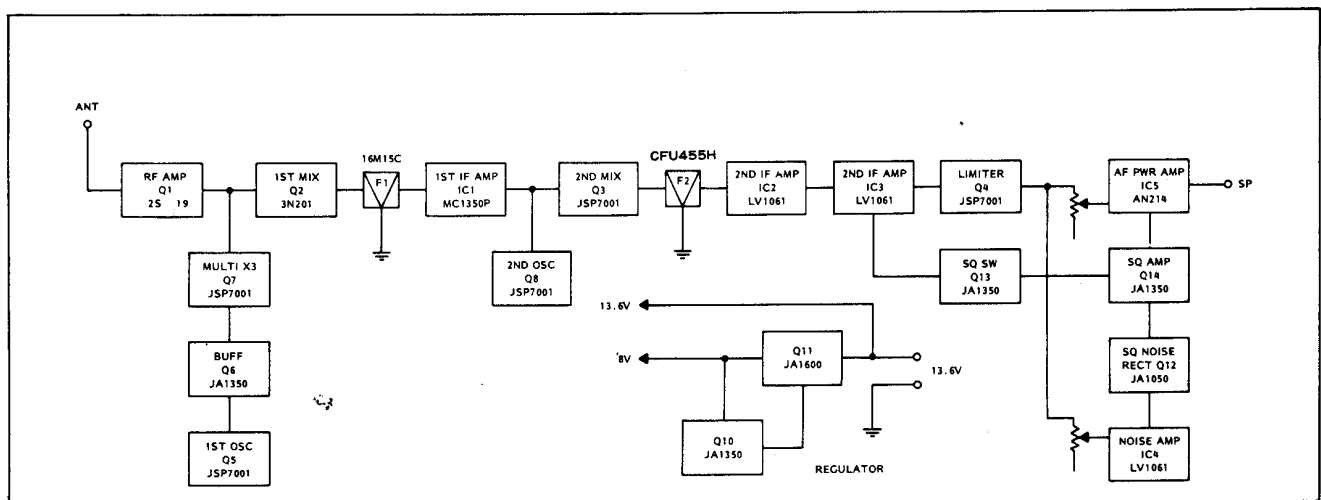

ALIGNMENT AND ADJUSTMENT – TRANSMITTER SECTION

13.6V. J1

Stage	Adjusting Point	Measuring Point	Alignment and Adjustment	Measuring Instruments
1 Regulator	VR102	Q111 Emitter	Connect the power meter to the output terminal of driver stage terminal. Measure the voltage of Q111 emitter, then rotate the semi-fixed variable resistor (VR102) so that the voltage goes to 8V.	VOM Power Meter (50Ω) Screw Driver
2 Oscillator	None	CP-101	Connect a vom to the check point CP-101, confirm the voltage is in oscillating condition on each channel. Normal voltage is; No Osc = approx. 1.5 – 1.6 DC Oscillating = approx. 1.6 – 1.7V DC	VOM
3. Multiplier				
a)	L101	CP-101	Set channel switch to A. Connect a VOM to check point CP-101, adjust the core of L101 for maximum indication on meter. Standard voltage = approx. 0.8V DC	VOM power meter 50Ω Screw Driver
b)	L102	CP-101	Adjust the core of L102 for minimum voltage at CP-101.	
b)	L102	CP-101		
c)	L102	CP-102	Connect the VOM to check point CP-102, adjust L103 and L102. For maximum indication on VOM. Repeat this adjustment two or three times. Standard voltage = approx. 1.57V DC	
d)	L104	CP-102	Adjust the coil L104 for minimum voltage at CP-102.	
e)	L104	CP-103	Connect the VOM to check point CP-103, adjust coil L104 and L105 for maximum voltage at CP-103.	
f)	VC113	CP-103	Adjust the semi-fixed capacitor VC113 for minimum voltage at CP-103.	
4 RF Amplifier	VC115 VC116 VC117 VC118 VC119	Power Meter	Adjust each semi-fixed capacitor VC115, VC116, VC117, VC118 and VC119 for maximum indication on power meter. This adjustment should be repeated several times until the power meter indicates 3W or more. Current flow is 200–300mA in this case. After finishing these adjustments, connect the RF output terminal of the exciter stage to the final and remove the power meter.	RF Power Meter (50Ω) Screw Driver
5 RF Power Amplifier High Power	VC201 VC202 VC203, S3 VC204 High	Power Meter	Connect a 30-watt Power Meter to J-2. Adjust VC201, VC202, VC203 and VC204 for maximum reading. Normal reading is approx. 20 – 25 watts.	RF Power Meter (30W, 50Ω)
6 Freq. Adjustment	VC101 to VC112	Coupling Attenuator	Emission frequency can be adjusted by VC101 – VC112. Frequency deflection at standard condition should be within ±0.0005%.	Freq. Counter Screw Driver Power Meter
7 Modulation	VR101		Connect Audio Frequency Generator to the Mike Terminal (J3) and apply audio frequency level of –20dBm/600Ω at 1,000 Hz. Adjust the semi-fixed resistor VR-101 for a deviation of 2.2KHz ±0.2KHz.	AF. Oscillator Power Meter (30W, 50Ω)

ALIGNMENT AND ADJUSTMENT – RECEIVER SECTION

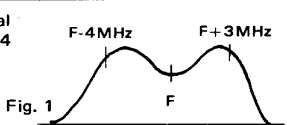
Stage	Adjusting Point	Measuring Point	Alignment and Adjustment	Measuring Instruments
1 AF Amplifier	None	Speaker terminal	Connect an Audio Frequency Generator to the center pin of AF volume control, then inject 50mV at 1 KHz. If the audio amplifier has no trouble, the voltage across speaker terminal will appear more than 3V (1W). Also observe the wave form for distortion by using an oscilloscope.	AF Generator Speaker 8Ω V.T.V.M. Oscilloscope
2 2nd Local Oscillator	VC13	CP-5	Connect a frequency counter to check point CP-5. Adjust trimmer capacitor VC13 so that the frequency obtained is 16.445 MHz.	Frequency
3 1st Local Oscillator	L10	CP-3	Connect the VOM to check point CP-3, select the channel with the highest frequency. Adjust the core of L10 from the end of minimum inductance until the voltage at CP-3 goes up suddenly. This means Oscillation has begun at this point. Normal reading is approximately 0.7V to 1V. Then, the core of L10 should be fixed at the point which is two additional clock-wise turns from the oscillating point.	VOM Freq. Counter
	L11	CP-3	Next, adjust the coil L11, so that the voltage of CP-3 will be at the same level at any channel between highest and lowest frequency.	
	VC1 thru VC12	CP-4	Connect a frequency counter to check point CP-4, adjust the oscillating frequency or each crystal by adjusting its associated variable capacitor VC1 thru VC12. Oscillation frequency is; Receiving frequency minus 16.9 MHz.	MHz mHz
4. RF Amplifier	L1 L2 L3 L4	CP1	Connect a sweep generator to the antenna terminal and check point CP1. Adjust L1, L2, L3 and L4 so that the scope pattern is identical to figure 1.	Sweep Generator Oscilloscope
			 <p>Fig. 1</p>	
5 Overall Adjustment	L12 L13 L5 L6 L7	CP-2 Speaker	Feed an RF signal to the antenna terminal at the selected channel frequency and adjust the frequency of SSG so that the noise level from the speaker terminal will be minimum or the voltage of CP-2 will reach maximum. Next, adjust the coil L12, L13, L5, L6 and L7 so that the voltage at check point CP-2 is maximum. Normal reading is approx. 0.5–1V. When the speaker noise level is preferred for adjustment, adjust the above coils so that the noise level from the speaker terminal will be reduced.	V.T.V.M. SSG Oscilloscope Tester
	L8	Speaker	Next, feed the modulated RF signal (1 KHz/± 2.0 KHz. dev.) to the antenna terminal and adjust coil L8 for maximum AF output.	
6 Squelch	None	Speaker	Normal operation of the squelch circuit requires that, when the squelch knob is rotated clockwise, the noise from the speaker must disappear at a point. If the squelch knob is fixed at this particular point, the circuit will be un-squelched by a 0.5μV incoming RF signal. If the squelch knob is rotated fully clockwise, from 2 to 3 μV RF signal level will be required.	

RECEIVER CIRCUIT BOARD-TOP VIEW

Be careful about placing

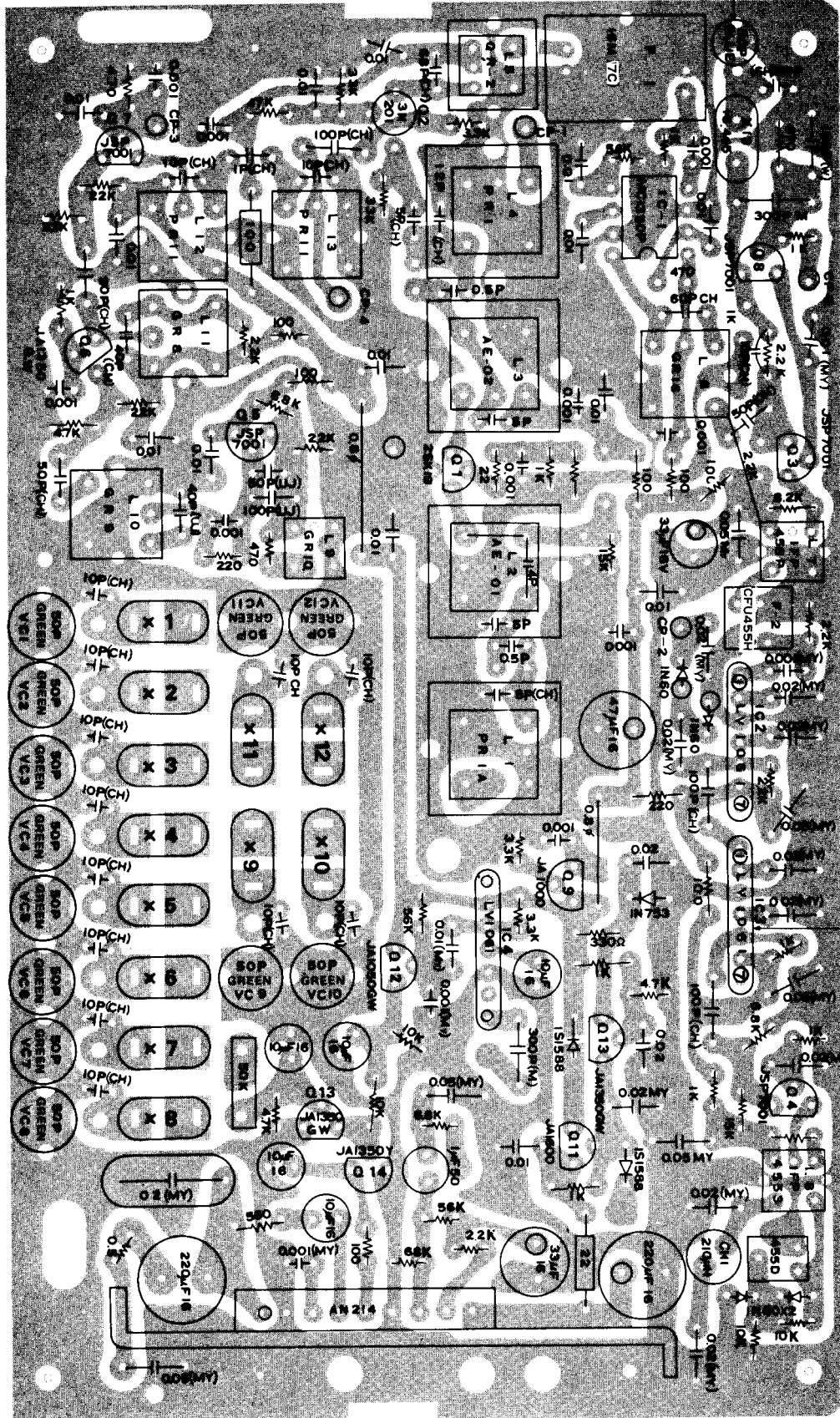

Be careful about placing direction.

RECEIVER CIRCUIT BOARD-BOTTOM VIEW

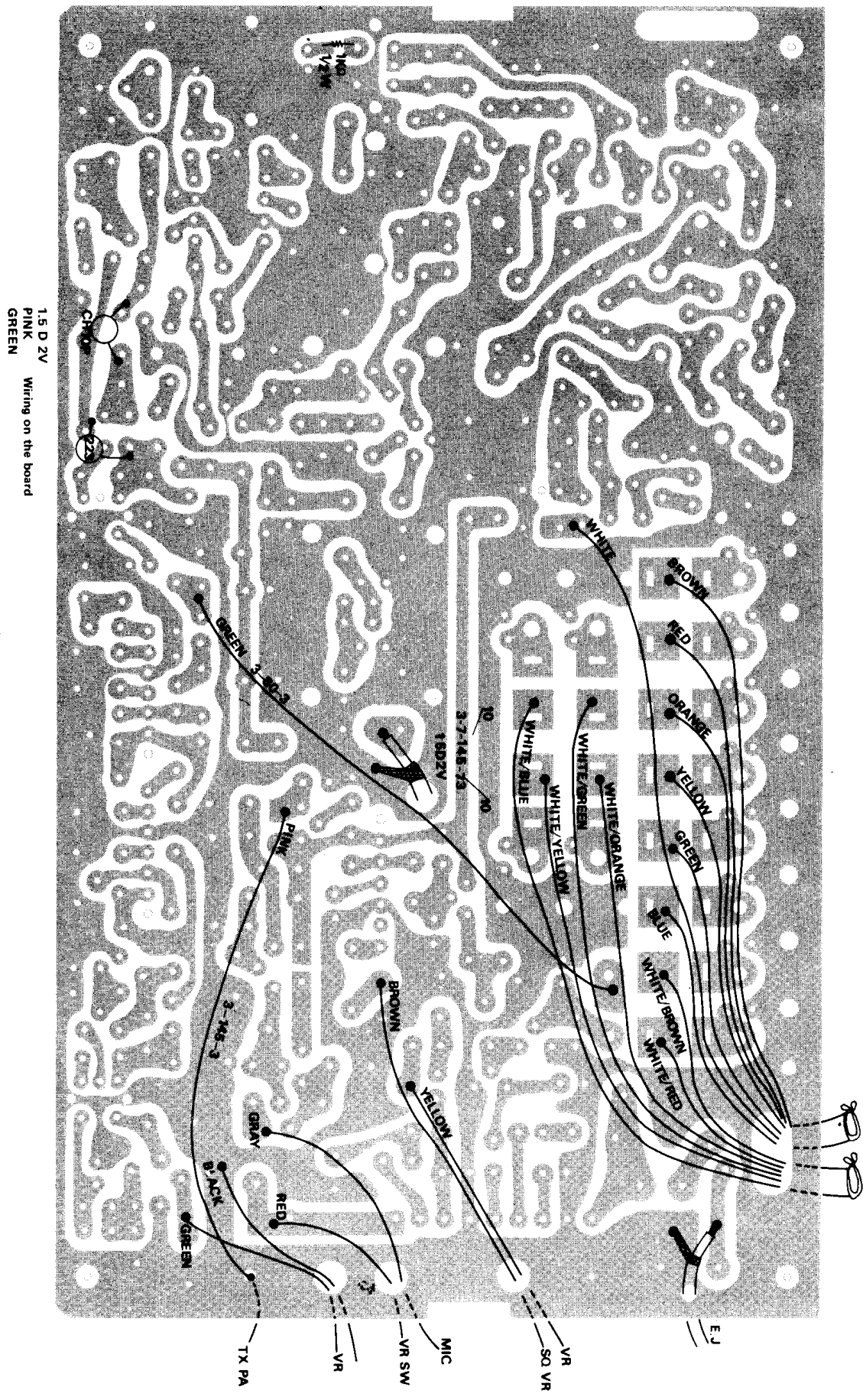

1.5 D 2V
 PINK
 GREEN
 Writing on the board

TRANSMITTER, EXCITER CIRCUIT BOARD-TOP

Be careful about placing direction

1) Electro Capacitor, Tantalum Capacitor (T), mark: * side
 2) Capacitor: (MY)-Mylar, (M)-Mica, (T)-Tantalum

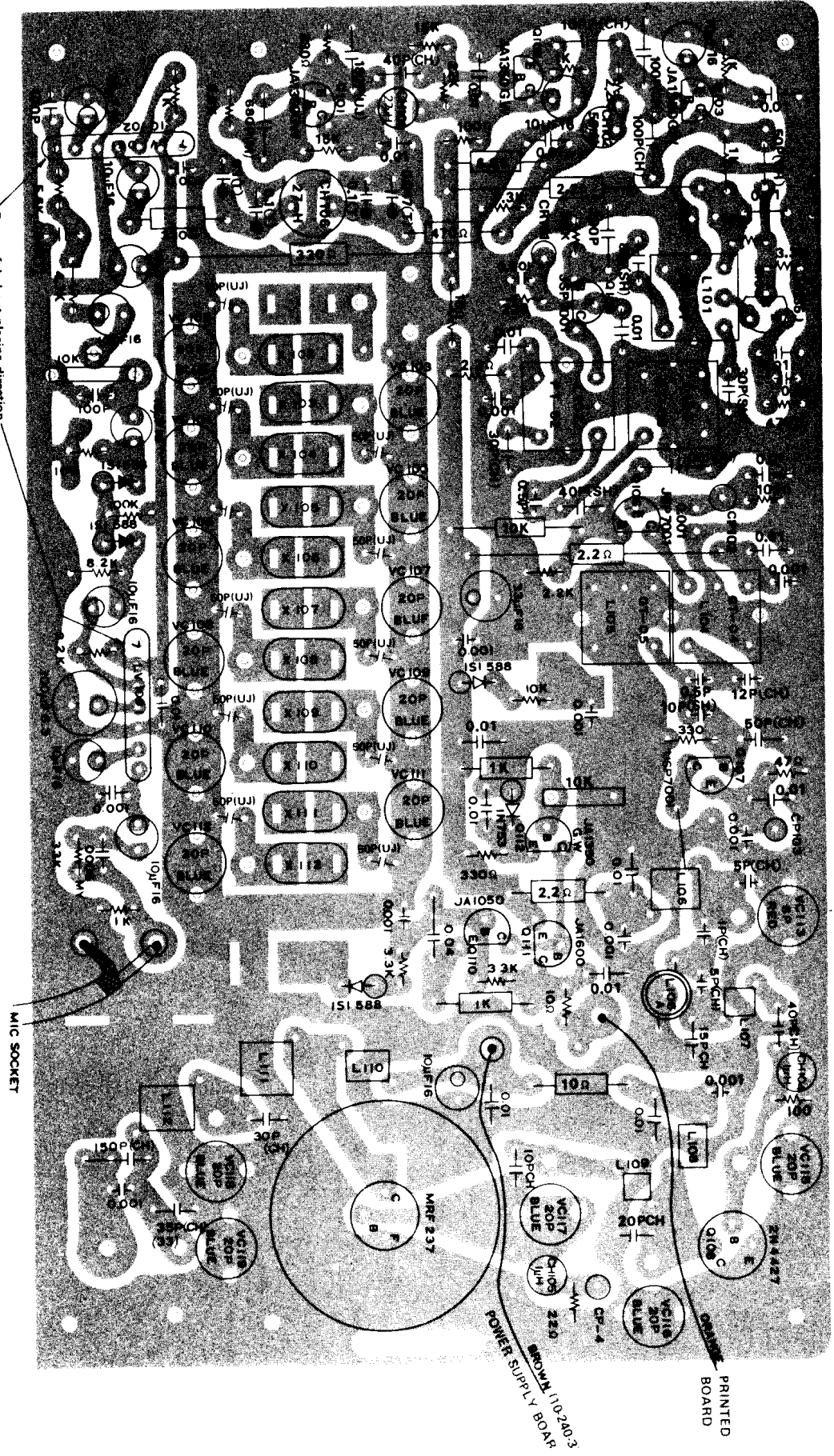

SMITTER, EXCITER CIRCUIT BOARD-BOTTOM VIE

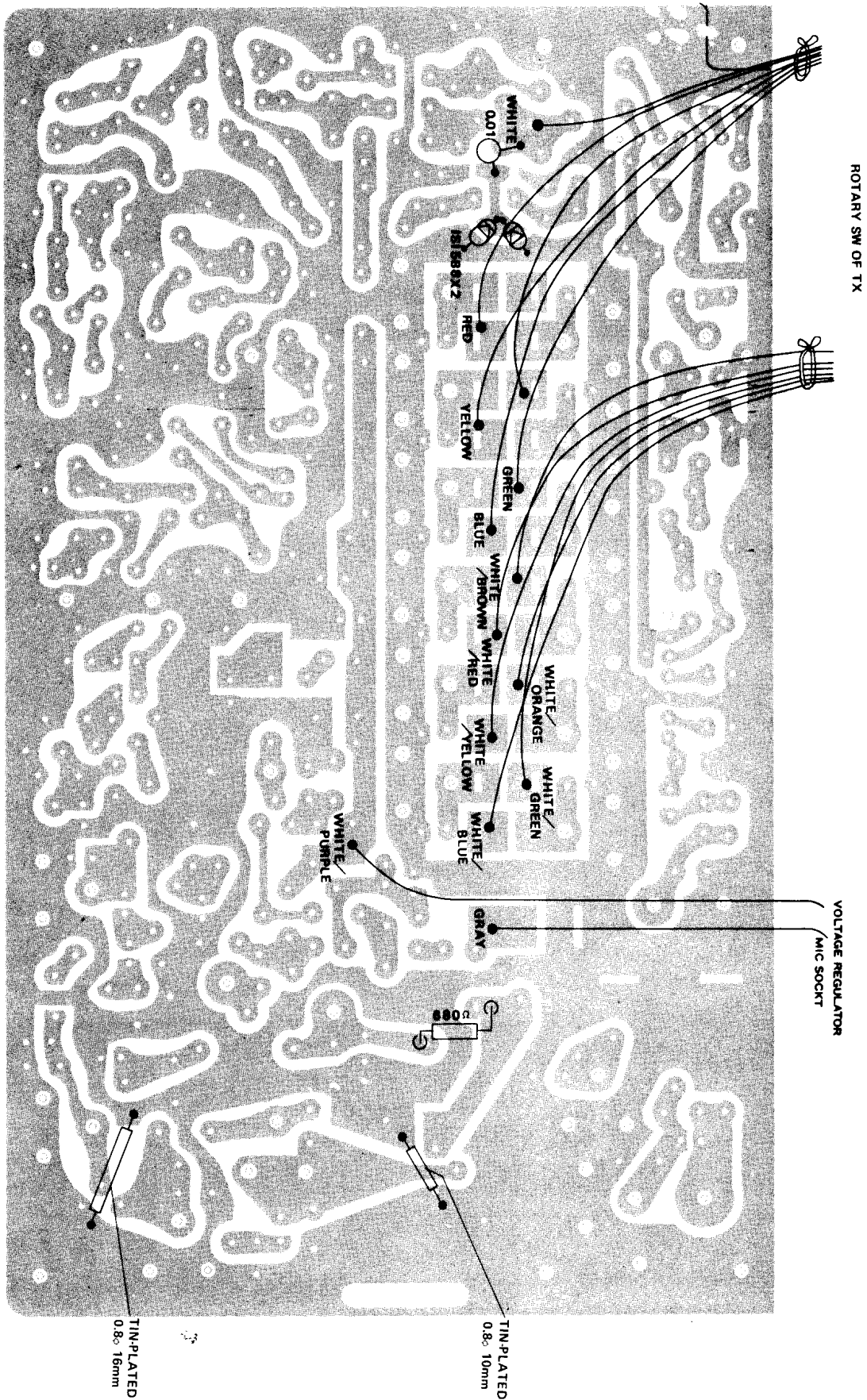

VOLTAGE REGULATOR CIRCUIT BOARD

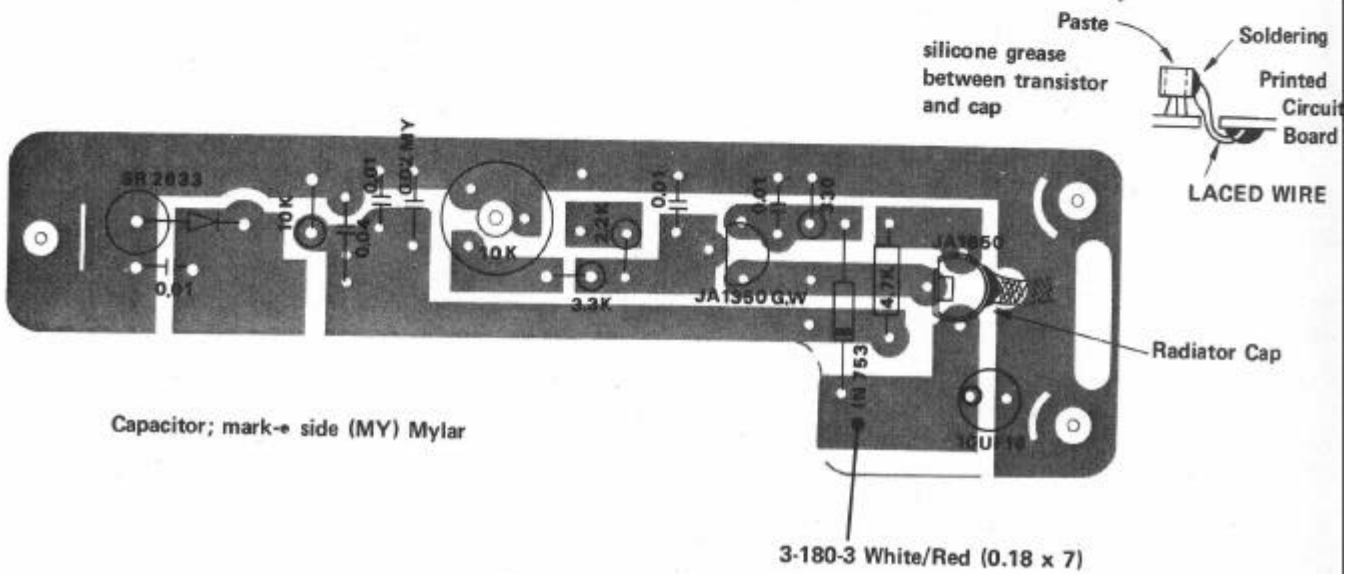
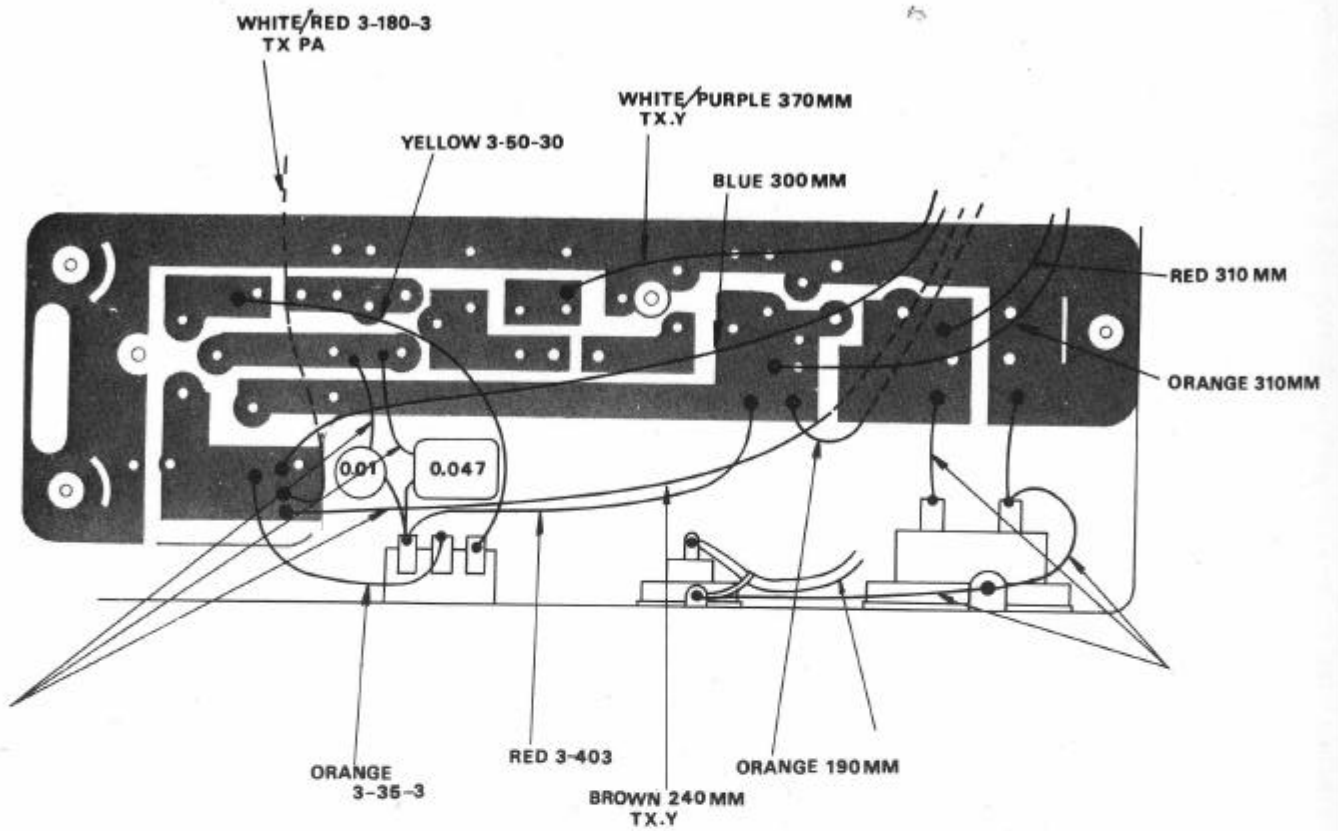

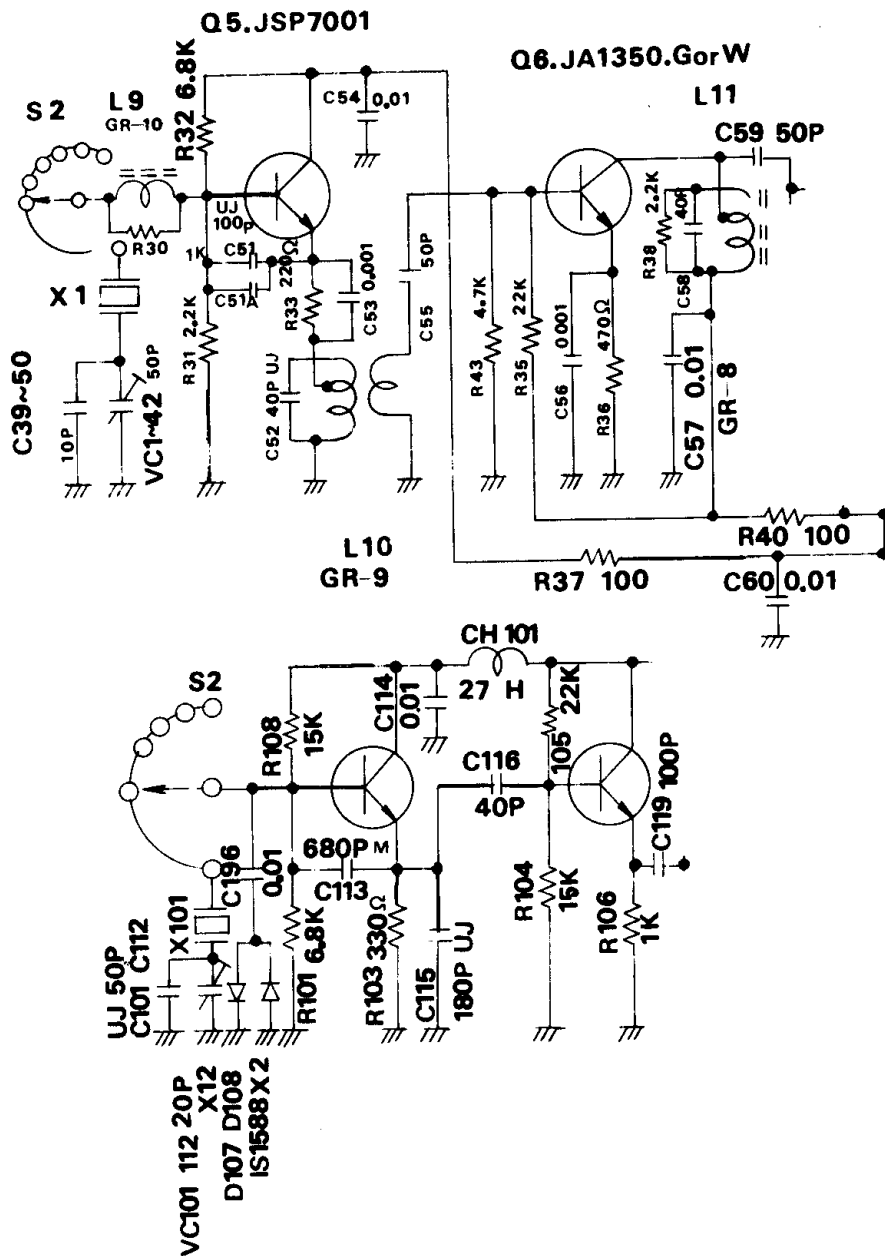

ADDING NEW CHANNELS

When adding new crystals, Receive and Transmit crystal frequency can be calculated from the following formula ;

- | | |
|---------------|-----------------------|
| ① Lodging Cap | Rx = Series Resonance |
| | Tx = 50.6p~51p |
| ② Co | 5 pF max |
| ③ Tolerance | 0.0005 % |
| ④ Drive level | 1 mW or Less |

$$\text{Receive Crystal (MHz.)} = \frac{\text{Operating Freq. (MHz.)} - 16.9 \text{ MHz.}}{3}$$

$$\text{Transmit Crystal (MHz.)} = \frac{\text{Operating Freq. (MHz.)}}{18}$$

POWER AMPLIFIER CIRCUIT BOARD

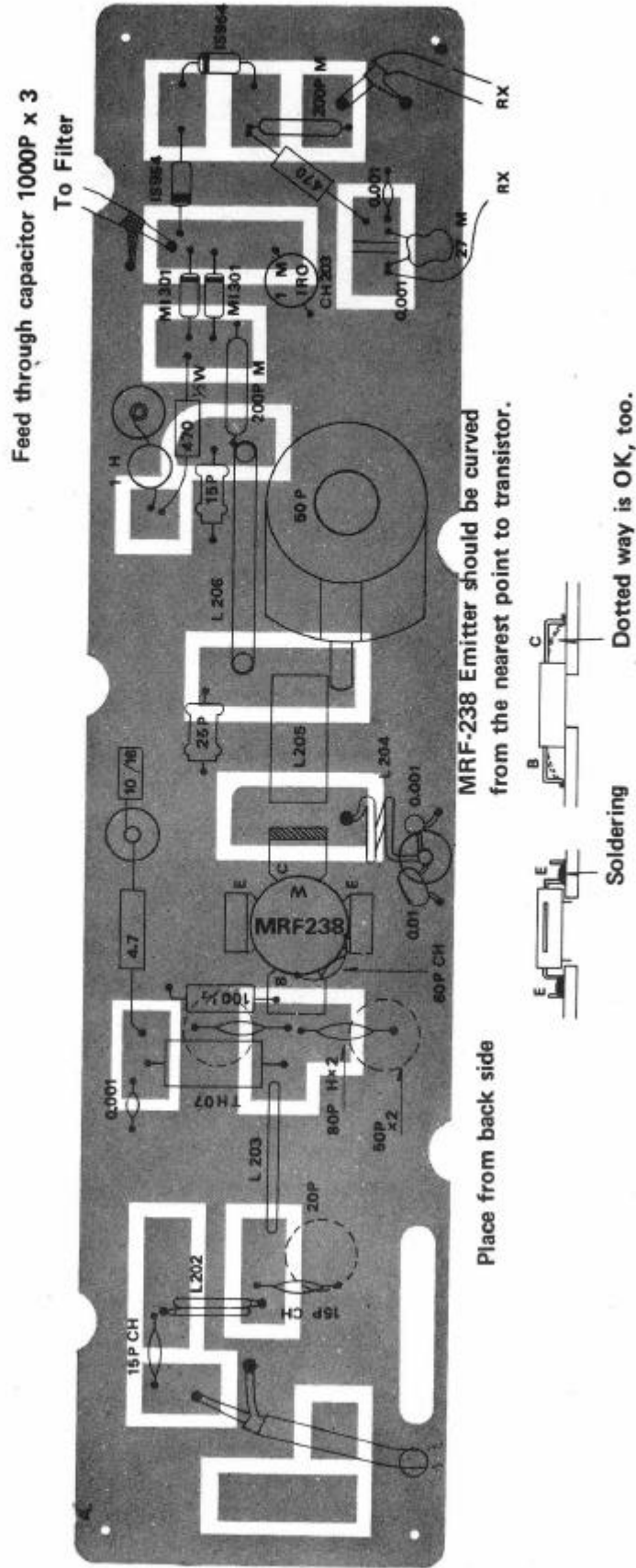

[Note] MRF-238 should be soldered either after Printed Board is put on Shassis, or after it is temporarily put on A, B.
Be sure of soldering after nuts are fixed.

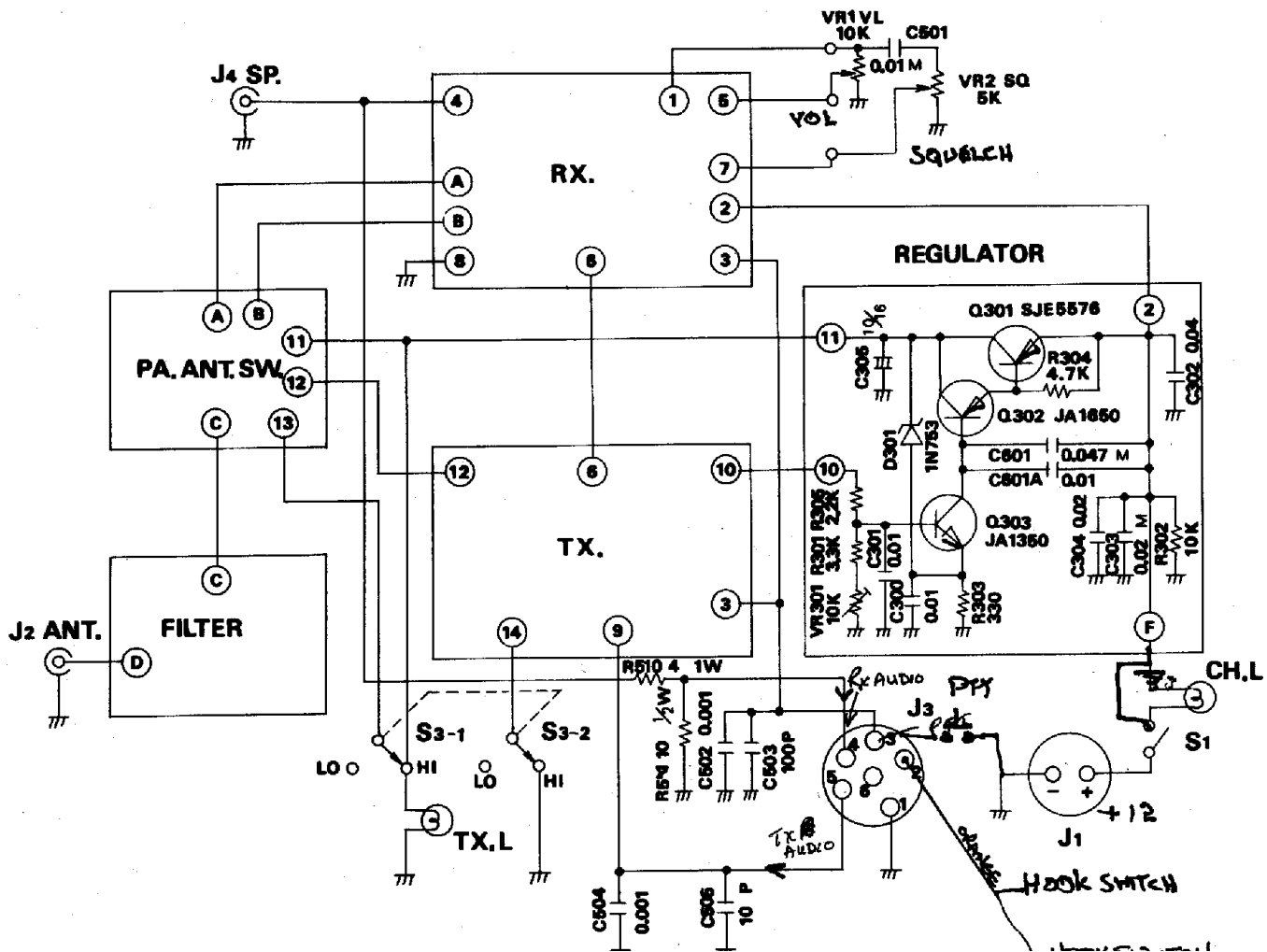

Symbol No.	Name of Parts	Description	Q'ty	Remarks
Q101	Transistor	JA1350G(N.P.N.) W	1	
Q102	"	" G or W	"	
Q103	"	" W	"	
Q104	"	" G or W	"	
Q105	"	JSP7001B	"	
Q106	"	"	"	
Q107	"	"	"	
Q108	"	2N4427	"	
Q109	"	MRF237	"	
Q110	"	JA1050G or W	"	
Q111	"	JA1600G or W	"	
Q112	"	JA1350G or W	"	
IC101	I.C.	LVI061	1	
IC 102	"	"	"	
D101	Diode	1S1588	1	
D102	"	"	"	
D103	"	SR2633	"	
D104	"	1S1588	"	
D105	"	1N753	"	
D106	"	1S1588	"	
D107 D108	"	"	2	
L101	Coil	PT-01	1	
L102	"	PT-02	"	
L103	"	GT-03	"	
L104	"	GT-04	"	
L105	"	GT-05	"	
L106	"	AIR INDUCTOR	"	
L107	"	"	"	
L108	"	"	"	
L109	"	"	"	
L110	"	"	"	
L111	"	"	"	
L112	"	"	"	
L106A		" with Core	"	
	Crystal Socket		12	
VC101 Thru:VC112	Ceramic Trimmer	20PF MAX	12	
VC113	"	6PF MAX	1	
VC115	"	20PF MAX	"	
VC116	"	"	"	
VC117	"	"	"	
VC118	"	"	"	
VC119	"	"	"	
CH101	Micro Inductor	27 μ H	1	
CH102	"	56 μ H	"	

Symbol No.	Name of Parts	Description	Q'ty	Remarks
CH103	Micro Inductor	μ	1	
CH104	"	1 μ H	"	
CH105	"	"	"	
CH106	"	27mH	"	
VR101	Semi-fixed Resistor	10K ohm	1	
VR102	"	"	"	
R101	Resistor	10K ohms	1	
R102	"	15K ohms	"	
R103	"	330 ohms	"	
R104	"	15K ohms	"	
R105	"	22K ohms	"	
R106	"	1K ohm	"	
R107	"	3.3K ohms	"	
R108	"	2.2K ohms	"	
R109	"	6.8K ohms	"	
R110	"	1K ohm	"	
R111	"	"	"	
R112	"	3.3K ohms	"	
R113	"	10K ohms	"	
R114	"	470 ohms	"	
R115	"	100 ohms	"	
R116	"	2.2 ohms	"	
R117	"	2.2K ohms	"	
R118				
R119	"	220 ohms	"	
R120	"	10 ohms	"	
R121	"	2.2 ohms	"	
R122	"	2.2K ohms	"	
R123	"	10K ohms	"	
R124	"	100 ohms	"	
R125	"	2.2 ohms	"	
R126	"	330 ohms	"	
R127	"	2.2 ohms	"	
R128	"	47 ohms	"	
R129	"	100 ohms	"	
R130	"	10 ohms	"	
R131	"	22 ohms	"	
R131A	"	680 ohms	"	
R133				
R134	"	470 ohms	"	
R135	"	330 ohms	"	
R136	"	1K ohm	"	
R137	"	56K ohms	"	
R138	"	47K ohms	"	
R139	"	10K ohms	"	
R140	"	8.2K ohms	"	
R141	"	100K ohms	"	
R142	"	2.2K ohms	"	

Symbol No.	Name of Parts	Description	Q'ty	Remarks	Symbol No.	Name of Parts	Description	Q'ty	Remark
R143	Resistor	330 ohms	1		C150	Capacitor	50PF Ceramic	1	
R144	"		"		C151	"	0.01 μ F "	"	
R145	"	33K ohms	"		C152	"	0.001 μ F "	"	
R146	"	1K ohm	"		C153	"	0.01 μ F "	"	
R147	"	10 ohms	"		C154	"	0.001 μ F "	"	
R148	"	3.3K ohms	"		C155	"	5PF "	"	
R149	"	"	"		C156	"	40PF "	"	
R150	"	1K ohm	"		C157	"	0.01 μ F "	"	
R151	"	330 ohms	"		C158	"	20PF "	"	
R152	"	1K ohm	"		C159	"	10PF "	"	
R153	"	10K ohms	"		C160	"		"	
C101-102	Capacitor	(UJ) 50PF Ceramic	12		C161	"	0.01 μ F Ceramic	"	
C113	"	680PF Mica	1		C162	"	30PF "	"	
C114	"	0.01 μ F Ceramic	"		C163	"	33PF "	"	
C115	"	(UJ) 180PF "	"		C164	"	10 μ F/16 Electrolytic	"	
C116	"	40PF "	"		C165	"	0.01 μ F Ceramic	"	
C117	"	0.01 μ F "	"		C166	"	150PF "	"	
C118	"	100PF "	"		C167	"	0.047 μ F/25 Tantalum	"	
C119	"	"	"		C168	"	0.1 μ F/25 "	"	
C120	"	"	"		C169	"	" "	"	
C121	"	0.01 μ F Ceramic	"		C170	"	" "	"	
C122	"	10 μ F/16V Electrolytic	"		C171	"	10 μ F/16V Electrolytic	"	
C123	"	0.01 μ F Ceramic	"		C172	"	" "	"	
C124	"	"	"		C173	"	100PF Ceramic	"	
C125	"	0.001 μ F "	"		C174	"	0.047 μ F/25V Tantalum	"	
C126	"	50PF "	"		C175	"	" "	"	
C127	"	10 μ F/16V Electrolytic	"		C176	"	10 μ F/16V Electrolytic	"	
C128	"	0.01 μ F Ceramic	"		C177	"	100PF Ceramic	"	
C129	"	0.001 μ F "	"		C178	"	10 μ F/16V Electrolytic	"	
C130	"	(SH) 30PF "	"		C179	"	0.001 μ F Ceramic	"	
C131	"	(SH) 80PF "	"		C180	"	10 μ F/16V Electrolytic	"	
C132	"	200PF Mica	"		C181	"	0.01 μ F Ceramic	"	
C133	"	1PF Ceramic	"		C182	"	10 μ F/16V Electrolytic	"	
C134	"	0.01 μ F "	"		C183	"	100 μ F/6.3V "	"	
C135	"	0.001 μ F "	"		C184	"	10 μ F/16V	"	
C136	"	0.01 μ F "	"		C185	"	0.001 μ F Ceramic	"	
C137	"	"	"		C186	"	10 μ F/16V Electrolytic	"	
C138	"	0.001 μ F "	"		C187	"	0.005 μ F Mylar	"	
C139	"	30PF "	"		C188	"	0.01 μ F Ceramic	"	
C140	"	0.5PF "	"		C189	"	" "	"	
C141	"	(SH) 40PF "	"		C190	"	" "	"	
C142	"	100PF "	"		C191	"	0.001 μ F Ceramic	"	
C143	"	0.01 μ F "	"		C192	"	0.01 μ F "	"	
C144	"	0.001 μ F "	"		C193	"	33 μ F/16V Electrolytic	"	
C145	"	0.01 μ F "	"		C194	"	0.001 μ F Ceramic	"	
C146	"	0.001 μ F "	"		C195	"	0.001 μ F "	"	
C147	"	12PF "	"		C133A	"	5PF "	"	
C148	"	0.5PF "	"		C133B	"	15PF "	"	
C149	"	(SH) 10PF "	"		C157A	"	0.001 μ F "	"	
					C191A	"	0.04 μ F "	"	

Symbol No.	Name of Parts	Description	Q'ty	Remarks
C198	Capacitor	0.01 μ F Ceramic	1	
CP101	Check Point		1	
CP102	"		"	
CP103	"		"	
Q201	Transistor with Nut	MRF238	1	
D201	Diode	M1301	1	
D202	"	"	"	
D203	"	1S954	"	
D204	"	"	"	
L201	Coil			
L202	"	Air Inductor	1	
L203	"	"	"	
L204	"	"	"	
L205	"	"	"	
L206	"	"	"	
CH201	Inductor	HT-07	1	
CH202	Microinductor	1 μ H	"	
CH203	"	1 μ H	"	
CH204	"	27 μ H	"	
VC202	Ceramic Trimmer	20PF MAX	1	
VC203	"	50PF "	"	
VC204	"	"	"	
VC205	"	"	"	
R201	Resistor	4.7 ohms	1	
R202	"	470 ohms 1/2W	"	
R203	"	"	"	
R204	"	100 ohms 1/2W	"	
C201	Capacitor		1	
C202	"	0.001 μ F Ceramic	1	
C203	"	15P "	"	
C204	"	"	"	
C205	"	1000PF Feedthrough	"	
C206	"	80PF	"	
C207	"	80PF	"	
C208	"	60PF	"	
C209	"	0.01 μ F Ceramic	"	
C210	"	0.001 μ F "	"	
C211	"	1000PF Feedthrough	"	
C212	"	25PF Ceramic	"	
C213	"	200PF Mica	"	
C214	"	1000PF Feedthrough	"	

Symbol No.	Name of Parts	Description	Q'ty	Remarks
C215	Capacitor	200PF Mica	1	
C216	"	0.001 μ F Ceramic	"	
C217	"	15PF "	"	
C218	"	10 μ F/18V Electrolytic	"	
Q301	Transistor	SJE5578	1	
Q302	"	JA1850G or W	"	
Q303	"	JA1350G or W	"	
D301	Diode	1N753	1	
R301	Resistor	3.3K ohms	1	
R302	"	10K ohms	"	
R303	"	330 ohms	"	
R304	"	4.7K ohms	"	
R305	"	2.2K ohms	"	
C301	Capacitor	0.01 μ F Ceramic	1	
C302	"	0.04 μ F "	"	
C303	"	0.02 μ F Mylar	"	
C304	"	0.02 μ F Ceramic	"	
C305	"	10 μ F/16V Electrolytic	"	
C306	"	0.01 μ F Ceramic	"	
VR301	Semi Fixed Resistor	10K ohms	1	
L401	Coil	Air Inductor	1	
L402	"	"	"	
L403	"	"	"	
L404	"	"	"	
C401	Capacitor (CH)	1PF Ceramic	1	
C402	" (CH)	20PF "	"	
C403	" (CH)	15PF "	"	
C404	" (CH)	10PF "	"	
C405	" (CH)	8PF "	"	
C406	" (CH)	10PF "	"	
C407	" (CH)	15PF "	"	
C408	" (CH)	20PF "	"	

RECEIVER

Symbol No.	Name of Parts	Description	Q'ty	Remarks	Symbol No.	Name of Parts	Description	Q'ty	Remarks
Q 1	Transistor	2SK19	1		VC1-12	Ceramic Trimmer	50P MAX	12	
Q 2	"	3N201 (FET)	"		VC13	"	20P MAX	1	
Q 3	"	JSP7001 (NPN)	"						
Q 4	"	"	"		CH 1	Micro Inductor	210 μ H	1	
Q 5	"	"	"						
Q 6	"	JA1350G. W (NPN)	"		B 1	Resistor	15K ohms	1	
Q 7	"	JSP7001 (NPN)	"		R 2	"	"	"	
Q 8	"	"	"		R 3	"	22 ohms	"	
Q 9	"	JA1000 (PNP)	"		R 4	"	1Kohms	"	
Q10	"	JA1350G. W (NPN)	"		R 5	"	100 ohms	"	
Q11	"	JA1800G. W (NPN)	"		R 6	"	33K ohms	"	
Q12	"	JA1080G. W (PNP)	"		R 7	"	47K ohms	"	
Q13	"	JA1350G. W (NPN)	"		R 8	"	33K ohms	"	
Q14	"	JA1350Y (NPN)	"		R 9	"	3.3K ohms	"	
					R10	"	100 ohms	"	
IC 1	I.C.	MC1350P	1		R11	"	1K ohm	"	
IC 2	"	LVI061	1		R12	"	5.6K ohms	"	
IC 3	"	"	"		R13	"	470 ohms	"	
IC 4	"	"	"		R14	"	100 ohms	"	
IC 5	"	AN214	1		R15	"	"	"	
					R16	"	2.2K ohms	"	
D 1	Diode	1N60	1		R17	"	"	"	
D 2	"	"	"		R18	"	6.8K ohms	"	
D 3	"	"	"		R19	"	2.2K ohms	"	
D 4	"	"	"		R20	"	220 ohms	"	
D 5	"	1N753	"		R21	"	2.2K ohms	"	
D 6	"	1S1588	"		R22	"	100 ohms	"	
D 7	"	"	"		R23	"	1K ohm	"	
					R24	"	"	"	
L 1	Coil	PR-1A	1		R25	"	6.8K ohms	"	
L 2	"	AE-01	"		R26	"	15K ohms	"	
L 3	"	AE-02	"		R27	"	1K ohm	"	
L 4	"	PR-1	"		R28	"	10K ohms	"	
L 5	"	QR-2	"		R29	"	"	"	
L 6	"	GR-16	"		R30	"	470 ohms	"	
L 7	"	IFP-455B	"		R31	"	2.2K ohms	"	
L 8	"	"	"		R32	"	6.8K ohms	"	
L 9	"	GR-10	"		R33	"	220 ohms	"	
L10	"	GR-9	"		R34	"	4.7K ohms	"	
L11	"	GR-8	"		R35	"	22K ohms	"	
L12	"	PR-11	"		R36	"	470 ohms--1K ohm	"	
L13	"	PR-11	"		R37	"	100 ohms	"	
					R38	"	2.2K ohms	"	
F 1	Filter	16M7C Crystal Filter	1		R39	"	3.3K ohms	"	
F 2	"	CFU455H	"		R40	"	100 ohms	"	
					R41	"	22K ohms	"	
	Crystal Socket		12		R42	"	470 ohms	"	
X13	Crystal	16.445 MHz	1		R43	"	1K ohm	"	
					R44	"	470 ohms	"	
DIS	Discriminator	455D	1		R45	"	3.3K ohms	"	

Symbol No.	Name of Parts	Description	Q'ty	Remarks
R46	Resistor	4.7K ohms	1	
R47	"	1K ohm	"	
R48	"	330 ohms	"	
R49	"	1K ohm	"	
R50	"	22 ohms	"	
R51	"		"	
R52	"	3.3K ohms	"	
R53	"	56K ohms	"	
R54	"	10K ohms	"	
R55	"		"	
R56	"	10K ohms	"	
R57	"	4.7K ohms	"	
R58	"		"	
R59	"	6.8K ohms	"	
R60	"	88K ohms	"	
R61	"	100 ohms	"	
R62	"	560 ohms	"	
R63	"	56K ohms	"	
R64	"	2.2K ohms	"	
R65	"	0.5 ohms 1W	"	
R11A	"	1K ohm 1/8W	"	
R44A	"	" 1/4W	"	
C 1	Capacitor	* 5PF Ceramic	1	
C 2	"	* 5PF "	"	
C 3	"	0.5PF "	"	
C 4	"	4PF "	"	
C 5	"	0.001 μ F "	"	
C 6	"	" "	"	
C 7	"	* 5PF "	"	
C 8	"	0.01 μ F "	"	
C 9	"	* 0.5P "	"	
C10	"	* 20PF "	"	
C11	"	* 12PF "	"	
C12	"	5PF "	"	
C13	"	0.01 μ F "	"	
C14	"	88PF "	"	
C15	"	0.01 μ F "	"	
C16	"	0.001 μ F "	"	
C17	"	0.01 μ F "	"	
C18	"	" "	"	
C19	"	" "	"	
C20	"	60PF "	"	
C21	"	50PF "	"	
C22	"	0.01 μ F Mylar	"	
C23	"	0.05 μ F "	"	
C24	"	0.001 μ F "	"	
C25	"	0.02 μ F "	"	
C26	"	0.02 μ F "	"	
C27	"	0.05 μ F "	"	

Symbol No.	Name of Parts	Description	Q'ty	Remarks
C28	Capacitor	0.02 μ F Mylar	1	
C29	"	100PF Ceramic	"	
C30	"	0.02 μ F Mylar	"	
C31	"	" "	"	
C32	"	" "	"	
C33	"	0.05 μ F "	"	
C34	"	100PF Ceramic	"	
C35	"	0.02 μ F Mylar	"	
C36	"	0.05 μ F "	"	
C37	"	0.02 μ F "	"	
C38	"	0.02 μ F "	"	
C39	"	10PF Ceramic	"	
C40	"	"	"	
C41	"	"	"	
C42	"	"	"	
C43	"	"	"	
C44	"	"	"	
C45	"	"	"	
C46	"	"	"	
C47	"	"	"	
C48	"	"	"	
C49	"	"	"	
C50	"	"	"	
C51	"	(UJ) 100PF Ceramic	"	
C52	"	(UJ) 40PF "	"	
C53	"	0.001 μ F "	"	
C54	"	0.01 μ F "	"	
C55	"	50PF "	"	
C56	"	0.01 μ F "	"	
C57	"	0.01 μ F "	"	
C58	"	40PF "	"	
C59	"	50PF "	"	
C60	"	0.01 μ F "	"	
C61	"	0.001 μ F "	"	
C62	"	0.01 μ F "	"	
C63	"	10PF "	"	
C64	"	5PF "	"	
C65	"	0.01 μ F "	"	
C66	"	10PF "	"	
C67	"	100PF "	"	
C68	"	(SH) 30PF "	"	
C69	"	300PF Mica	"	
C70	"	(UJ) 180PF Ceramic	"	
C71	"		"	
C72	"	0.001 μ F Ceramic	"	
C73	"	47 μ F/16V Electrolytic	"	
C74	"	0.01 μ F Ceramic	"	
C75	"	0.02 μ F "	"	
C76	"	0.02 μ F "	"	
C77	"	0.02 μ F Mylar	"	

Symbol No.	Name of Parts	Description	Q'ty	Remarks
C78	Capacitor	0.01 μ F Ceramic	1	
C79	"	200PF Mica	"	
C80	"	10 μ F/16V Electrolytic	"	
C81	"	0.01 μ F Mylar	"	
C82	"	0.001 μ F "	"	
C83	"	10 μ F/16V Electrolytic	"	
C84	"	"	"	
C85	"	1 μ F/50V	"	
C86	"	0.05 μ F Mylar	"	
C87	"	10 μ F/16V Electrolytic	"	
C88	"	"	"	
C89	"	0.001 μ F Mylar	"	
C90	"	33 μ F/16V Electrolytic	"	
C91	"	220 μ F/16V "	"	
C92	"	0.2 μ F Mylar	"	
C93	"	220 μ F/16V Electrolytic	"	
C94	"	0.05 μ F Mylar	"	
C95	"	0.001 μ F Ceramic	"	
C 3A	"	0.5PF "	"	
C15A	"	0.001 μ F "	"	
C19A	"	" "	"	
C23A	"	33 μ F/16V Electrolytic	"	
C51A	"	(UJ) 50PF Ceramic	"	
C61A	"	0.01 μ F "	"	

Symbol No.	Name of Parts	Description	Q'ty	Remarks
CR 1	Check Point	Check Point	1	
CR 2	"	"	"	
CR 3	"	"	"	
CR 4	"	"	"	
CR 5	"	"	"	
X 1	Crystal		1	
X 2	"		"	
X 3	"		"	
X 4	"		"	
X 5	"		"	
X 6	"		"	
X 7	"		"	
X 8	"		"	
X 9	"		"	
X10	"		"	
X11	"		"	
X12	"		"	

CABINET

Symbol No.	Name of Parts	Description	Q'ty	Remarks
C501	Capacitor	0.01 μ F Mylar	1	
C502	"	0.001 μ F Ceramic	"	
C503	"	100PF "	"	
C504	"	0.001 μ F "	"	
C505	"	100PF "	"	
C601	Capacitor	0.047 μ F Mylar	1	
C601A	"	0.01 μ F Ceramic		
VR1	Volume Control	10K ohms A Curve	1	
	with Nut		1	
	Plain Washer		1	
VR2	Squelch Control	5K ohms B Curve	1	
	with Nut		1	
	Plain Washer		1	
S2	Rotary Switch	12 Position 2 Circuit	1	
	with Nut		1	
	Plain Washer		2	

Symbol No.	Name of Parts	Description	Q'ty	Remarks
	Pockey Switch	DPDT	1	
	Screw	DAN 2.8x5 ISO	2	
	Spring Lock Washer		2	
	Mic. Connector		1	
	Spring Lock Washer		1	
	Lamp Holder		1	
	Lamp	16V 80mA	2	
	Lamp Cover	TX Light Red	1	
	" "	Power on Light	1	
	Knob	Channel	1	
	with Set Screw		1	
	Knob	SQ. VOL. Control	2	
	with Set Screw		2	

Symbol No.	Name of Parts	Description	Q'ty	Remarks
	Channel Disc		1	
	Screw	Truss 2x8 ISO	2	
	Front Name Plate		1	
	Screw	Truss 2x6 ISO	4	
	Front Panel		1	
	Screw	Truss 2.6x8 IYO S	4	
	Screw	Pan 2.6x5 ISO	2	
	Lug		2	
	Rear Chassis		1	
	Power Connector	Two Pin Male	1	
	with Nut		1	
	Lug		1	
	Spring Lock Washer		1	
	SP. Jack		1	
	with Nut		1	
	Lug		1	
	Plain Washer		1	
	Ant. Connector	CO-AXIAL SO-239	1	
	Screw	PAN 2.5x12 ISO	1	
	Screw	PAN 2.6x5 ISO	3	
	Spring Lock Washer	2.6φ	4	
	Upper Cover		1	
	Lower Cover		1	
	Screw	Truss 2.6x4 ISO	8	
	Bracket		1	
	Thumb Screw		4	
	Microphone	600 ohms Dynamic	1	
	with P.T.T. Switch		1	
	MIC. Plug	STX Pin Female	1	
	Power Cord		1	
	with Fuse Holder		1	
	Two Pin Female Plug		1	
	Fuse	10A	1	
	SP. Box		1	
	Speaker	8 ohms 70mm	1	

Symbol No.	Name of Parts	Description	Q'ty	Remark
	Rear Cover		1	
	SP. Stopper		2	
	SP. Plug		1	
	Cord	850 mm	1	
	Cord Stopper		1	
	Screw	PAN 3x25 ISO	4	
	Spring Lock Washer	3φ	4	
	SP. Box Bracket		1	
	Thumb Screw		2	
	Screw	PAN 2.6x5		
	"	PAN 2.6x5	3	
	"	PAN 2.6x10	3	
	"	PAN 2.6x12	1	
	Spring Lock Washer	2.6φ	7	

R501	Resistor	4 ohms 1W	1	
R502	"	10 ohms 1/2W	1	

TO FIT MURA MIC (YAESU TYPE)
 REMOVE 0.22μF ACROSS MIC I/P TO PC
 1. R145 33K
 FIT C 184 4.7μF IF NOT FITTED

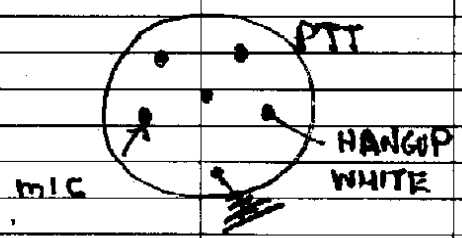

MIKE GAIN IS ON TAG STRIP ON FRONT PANEL

Zycomm FM2512 Crystals

Frequency	TX crystal	RX crystal	Frequency	TX crystal	RX crystal
144.50000	8.027777778	41.53333333	145.2375	8.06875	41.77916667
144.51250	8.028472222	41.5375	145.25000	8.069444444	41.78333333
144.52500	8.029166667	41.54166667	145.26250	8.070138889	41.7875
144.53750	8.029861111	41.54583333	145.27500	8.070833333	41.79166667
144.55000	8.030555556	41.55	145.28750	8.071527778	41.79583333
144.56250	8.03125	41.55416667	145.30000	8.072222222	41.8
144.57500	8.031944444	41.55833333	145.31250	8.072916667	41.80416667
144.58750	8.032638889	41.5625	145.32500	8.073611111	41.80833333
144.60000	8.033333333	41.56666667	145.33750	8.074305556	41.8125
144.61250	8.034027778	41.57083333	145.35000	8.075	41.81666667
144.62500	8.034722222	41.575	145.36250	8.075694444	41.82083333
144.63750	8.035416667	41.57916667	145.37500	8.076388889	41.825
144.65000	8.036111111	41.58333333	145.38750	8.077083333	41.82916667
144.66250	8.036805556	41.5875	145.40000	8.077777778	41.83333333
144.67500	8.0375	41.59166667	145.41250	8.078472222	41.8375
144.68750	8.038194444	41.59583333	145.42500	8.079166667	41.84166667
144.70000	8.038888889	41.6	145.43750	8.079861111	41.84583333
144.71250	8.039583333	41.60416667	145.45000	8.080555556	41.85
144.72500	8.040277778	41.60833333	145.46250	8.08125	41.85416667
144.73750	8.040972222	41.6125	145.47500	8.081944444	41.85833333
144.75000	8.041666667	41.61666667	145.48750	8.082638889	41.8625
144.76250	8.042361111	41.62083333	145.50000	8.083333333	41.86666667
144.77500	8.043055556	41.625	145.51250	8.084027778	41.87083333
144.78750	8.04375	41.62916667	145.52500	8.084722222	41.875
144.80000	8.044444444	41.63333333	145.53750	8.085416667	41.87916667
144.81250	8.045138889	41.6375	145.55000	8.086111111	41.88333333
144.82500	8.045833333	41.64166667	145.56250	8.086805556	41.8875
144.83750	8.046527778	41.64583333	145.57500	8.0875	41.89166667
144.85000	8.047222222	41.65	145.58750	8.088194444	41.89583333
144.86250	8.047916667	41.65416667	145.60000	8.088888889	41.9
144.87500	8.048611111	41.65833333	145.61250	8.089583333	41.90416667
144.88750	8.049305556	41.6625	145.62500	8.090277778	41.90833333
144.90000	8.05	41.66666667	145.63750	8.090972222	41.9125
144.91250	8.050694444	41.67083333	145.65000	8.091666667	41.91666667
144.92500	8.051388889	41.675	145.66250	8.092361111	41.92083333
144.93750	8.052083333	41.67916667	145.67500	8.093055556	41.925
144.95000	8.052777778	41.68333333	145.68750	8.09375	41.92916667
144.96250	8.053472222	41.6875	145.70000	8.094444444	41.93333333
144.97500	8.054166667	41.69166667	145.71250	8.095138889	41.9375
144.98750	8.054861111	41.69583333	145.72500	8.095833333	41.94166667
145.00000	8.055555556	41.7	145.73750	8.096527778	41.94583333
145.01250	8.05625	41.70416667	145.75000	8.097222222	41.95
145.02500	8.056944444	41.70833333	145.76250	8.097916667	41.95416667
145.03750	8.057638889	41.7125	145.77500	8.098611111	41.95833333
145.05000	8.058333333	41.71666667	145.78750	8.099305556	41.9625
145.06250	8.059027778	41.72083333	145.80000	8.1	41.96666667
145.07500	8.059722222	41.725	145.81250	8.100694444	41.97083333
145.08750	8.060416667	41.72916667	145.82500	8.101388889	41.975
145.10000	8.061111111	41.73333333	145.83750	8.102083333	41.97916667
145.11250	8.061805556	41.7375	145.85000	8.102777778	41.98333333
145.12500	8.0625	41.74166667	145.86250	8.103472222	41.9875
145.13750	8.063194444	41.74583333	145.87500	8.104166667	41.99166667
145.15000	8.063888889	41.75	145.88750	8.104861111	41.99583333
145.16250	8.064583333	41.75416667	145.90000	8.105555556	42
145.17500	8.065277778	41.75833333	145.91250	8.10625	42.00416667
145.18750	8.065972222	41.7625	145.92500	8.106944444	42.00833333
145.20000	8.066666667	41.76666667	145.93750	8.107638889	42.0125
145.21250	8.067361111	41.77083333	145.95000	8.108333333	42.01666667
145.22500	8.068055556	41.775	145.96250	8.109027778	42.02083333
145.23750	8.06875	41.77916667	145.97500	8.109722222	42.025
145.25000	8.069444444	41.78333333	145.98750	8.110416667	42.02916667